



# DYNACOMP

## TABLE OF CONTENTS (Part 1)

SECTION	PAGE
COMPUTERS and REQUIREMENTS	1
AVAILABILITY and PRICES	2
ORDER FORMS	3
CUSTOMER COMMENTS	5
AUTHOR MESSAGE	6
IMPORTANT NOTICES	7
DYNACOMP CONSULTING	9
FORMAT CONVERSION	10
EDUCATION	
YOUNG	11
GENERAL	14
SCIENCE/MATH	18
LANGUAGE ARTS	23
REMEDIAL READING	26
HEALTH/NUTRITION	27
TYPING SKILLS	29
RECORD KEEPING	30
TEACHING AIDS	31
SELF	34
MUSIC	35
ENGINEERING TUTORIALS	37
PORTFOLIO MANAGEMENT	40
BUSINESS/INVESTMENT	42
BUSINESS/ACCOUNTING	48
BUSINESS/GENERAL	51
BUSINESS/SALES	58
PERSONAL PRODUCTIVITY	59
PERSONAL FINANCE	60
DATABASE MANAGEMENT	63
WORD PROCESSING	72
BETTOR'S CORNER	74
STATISTICS	76
FORECASTING	87
ASTROLOGY	90
FORECASTING/SALES	91
BALLISTICS	91
POTPOURRI	92
CHEMICAL ENGINEERING	93
SOLAR ENGINEERING	95
ENGINEERING ANALYSIS	96
MECHANICAL ENGINEERING	98
LINEAR PROGRAMMING	102
OPTIMIZATION	102
MISC. ENGINEERING	103
ELECTRICAL ENGINEERING	103

\$2.00 U.S.

## Catalog No. 30

- *Largest Selection Available*
- *Public Domain Libraries*
- *Conversion Services*
- *Quantity Discounts*
- *... And More!*

*Quality Software  
for  
Microsystems*

● APPLE

● ATARI

● CANON

● COMMODORE

● COMPAQ

● 8-INCH IBM

● EPSON

● HEATH/ZENITH

● IBM

● KAYPRO

● MACINTOSH

● MORROW

● NEC

● NORTH STAR

● OSBORNE

● TRS-80

● CP/M

● AND MANY SPECIAL FORMATS

● MS-DOS

## TABLE OF CONTENTS (Part 2)

SECTION	PAGE
FOURIER/FILTER ANALYSIS	108
MATH MASTER SERIES	111
SCIENCE and MATHEMATICS	112
MATH GRAPHICS	117
BASIC SCIENTIFIC SUBROUTINES	119
DIGITAL IMAGE PROCESSING	121
ADAM OSBORNE COLLECTION	122
ASTRONOMY	123
COMPUTER SCIENCE	126
GRAPHICS	129
GENERAL UTILITIES	138
COMMUNICATIONS	142
ADVENTURE GAMES	143
CARD GAMES (BRIDGE)	147
CARD GAMES	150
BOARD GAMES	151
FLYING	154
WAR GAMES	155
BUSINESS GAMES	158
THOUGHT PROVOKERS	158
TRIVIA	160
GENERAL and ARCADE GAMES	161
GAMES PACKS	161
LATE ARRIVALS	166
PUBLIC DOMAIN	
COMMODORE-64	169
CP/M and IBM DIRECTORY	169
IBM PC-SIG	170
IBM PC-BLUE	174
IBM PC-GREEN	176
APPLE PASCAL	176
APPLE COLLECTION #1	177
APPLE COLLECTION #2	177
APPLE CP/M	179
CP/M PICONET	179
CP/M COLLECTION #1	180
KAYPRO USER'S GROUP	180
SIG/M CP/M USER'S GROUP	181
CMUG CP/M USER'S GROUP	184
ATARI COLLECTION #2	186
ATARI COLLECTION #3	188
ATARI ANTIC®	189
BOOKS	191
SUPPLIES and HARDWARE	192
WARRANTY	BACK COVER



# COMPUTERS AND REQUIREMENTS

Altos	CP/M and MBASIC (8" drive version only)
Apple II	Applesoft BASIC (Apple II plus, E, C, and compatibles)
Atari 400/800/130XE/XL*	Atari BASIC cartridge (400/800)
Canon AS-100	MS-DOS and MBASIC
Cromemco	CDOS and BASIC (8" and 5¼" special formats)
8" CP/M	Required: IBM 3740 disk format compatibility. Also required: MBASIC (except for EBASIC, CRANSTON MANOR, DYNAFORTH, IRON CLADS, and other specifically indicated programs, which require only CP/M, or when stated otherwise.)
Heath/Zenith Z-89	CP/M and MBASIC (8" CP/M disks only)
Heath/Zenith Z-100	ZDOS and ZBASIC (Special Format)
IBM PC/PC Jr. / XT / AT	PC-DOS or MS-DOS, and BASIC (for compatibles: MS-DOS and GW BASIC)
Kaypro	CP/M and MBASIC
Morrow Designs I, II, and III	CP/M and MBASIC
NEC PC 8000	NBASIC or MBASIC (state which)
North Star	5¼" Diskette, North Star DOS and North Star BASIC or CP/M and Microsoft BASIC (state which)
Osborne	CP/M and MBASIC
PET/CBM**	Commodore BASIC
SuperBrain/Compustar	CP/M and MBASIC
TRS-80***	Level II BASIC, Model I, III, or IV
Xerox 820/820 II	CP/M and MBASIC
Others	See "Special Order Formats"

\* Most Atari programs require 24K. Those that will run in 16K are so marked in the catalog. If you have an XL or XE, you have enough memory for any programs listed.

\*\* PET/CBM diskettes come in 1541 format. They cannot be loaded from 8050 disk drives.

\*\*\* TRS-80 diskettes do not come with TRS-DOS or BASIC on them.

All TRS-80 programs will run on the Model III and IV with the exceptions of TIDY, GRAFIX, CRIBBAGE, and CHESSMASTER. Model I to Model III conversion program is required unless diskettes are specifically formatted for the Model III or IV. See the TRS-80 notice.

Altos, Apple, Atari, Canon, CP/M, Cromemco, Heath, IBM, Kaypro, MBASIC, Morrow, NBASIC, NEC, North Star, Osborne, PC 8000, PET/CBM, SuperBrain, TRS-80, Xerox, and Zenith are trade names and/or trademarks.

©1984 Promedia Associates

**DYNACOMP, Inc. P.O. Box 18129 Rochester, New York, 14618**  
**(800) 828-6772 Toll Free Order Phone (outside NY only)**  
**(716) 671-6160 Office Phone (9 a.m. til 5 p.m. E.S.T.)**  
**(716) 671-6167 24-hour order and message phone.**

# AVAILABILITY AND PRICES

## WHICH COMPUTER?

DYNACOMP distributes programs for all of the computers and systems listed on the facing page. However, not all programs run on all computers. To avoid confusion, we have chosen a consistent way of indicating which runs on what. This information accompanies the description of each program, and is also shown in the availability tables.

Beneath the title of each program description is a simple caption having one of four forms:

1. "X, Y and Z only"
2. "available for all computers"
3. "available for all computers except X, Y and Z"
4. "CP/M only"

The meaning of the first form is self-evident. The second one means all of the computers listed under "COMPUTERS AND REQUIREMENTS" and "SPECIAL FORMATS". The third form means all of those computer except "X, Y, and Z". The fourth notation ("CP/M only") is a shorthand for the following:

CP/M=Osborne, North Star CP/M, SuperBrain, NEC PC 8000 CP/M, KAYPRO II, MORROW DESIGNS, HEATH ZENITH Z-100, HEATH ZENITH H-89 8" CP/M, CROMEMCO, ALTOS, XEROX 820, IBM PC/PC Jr., SANYO (with MS DOS), PANASONIC, COMPAQ Z or BA, CANON AS-100, DEC RAINBOW 100 (with MS DOS), and other CP/M IBM 3740 systems.

Unless otherwise noted, "CP/M only" also means that Microsoft BASIC is required.

## WHICH CP/M?

DYNACOMP's CP/M-Microsoft BASIC programs are compatible with CP/M 1.4, 2.2, and MP/M, and with Microsoft BASIC versions 4.51, 5.2 (or higher), and the BASIC-80 interpreter. No special printer or screen graphics capabilities are required unless specifically noted.

## SINGLE DENSITY/DOUBLE DENSITY

DYNACOMP recommends that if your computer accepts both single and double density diskettes, you should order the software you want in the single-density format and later convert it to double density. If you want double density, add \$3.00 to the diskette price shown in the program description.

The exceptions to this recommendation are the North Star Advantage, Kaypro, and Osborne-1 double density model. The North Star Advantage will simply not read single-density disks. The Osborne-1 and Kaypro double-density systems do, but with perhaps 90% reliability. We *strongly* recommend that double-density disks be ordered for these machines.

## HOW MUCH MEMORY IS REQUIRED?

A point of possible confusion is how much memory is required to run a particular program. Unless otherwise stated, all of DYNACOMP's programs will run in 16K of program memory for all machines except the Atari which requires 24K. (Several of DYNACOMP's Atari programs will run in 16K and are so marked.) This means that for an Apple II Plus disk system, 32K is required (so that at least 16K of memory is available after the disk operating system is loaded). For a CP/M system, the 16K refers to how much memory is free for use after BASIC has been loaded. Programs which require more memory are so indicated.

## AND THEN THERE IS THE COMMODORE

PET/CBM programs are available on both cassette and diskette. However, the diskette versions can be loaded only using 2040, 4040, and Commodore 64 or 128 disk drives. For those having 8050 drives (or wishing to save money), the cassette versions may be loaded and saved on diskette. However, the cassette versions save data to tape only!

## PACKAGE PRICES

There are several groups of software packages which naturally form sets. Examples include the three Fourier analysis programs, the three regression programs, Volumes I and II of BASIC SCIENTIFIC SUBROUTINES, the NSSE library, and others. DYNACOMP offers each of these groups at a reduced package price. These reduced-price packages *DO NOT* count toward the 10% and 20% quantity discounts indicated on the order form.







## HERE'S WHAT DYNACOMP'S CUSTOMERS SAY ABOUT OUR PRODUCTS AND SERVICES

### From a first-time customer . . . .

"I was very impressed by your prompt service and the quality of your product. It is nice to see that a mail order company can be both reputable and efficient."

*Dr. A.R.B., Madison, Wisconsin  
Personal Finance System, Osborne*

### From returned registration cards . . . .

"Excellent. My 3½ year old really enjoys it!"

*B. Y., Kendall Park, New Jersey  
Hodge Podge, Apple*

"Fantastic."

*P.W.S., Boulder, Colorado  
Children's Carrousel, Apple*

### From a repeat customer . . . .

"I received the blank disks and Personal Finance System yesterday afternoon. As in the past, I was pleased with the products and with the rapid, accurate service."

*A.R.W., Norfolk, Virginia*

### A customer with a catalog "problem" . . . .

"Just got my CELESTIAL BASIC program disks and they're great! . . . Everybody is borrowing my software catalog — please send me another copy."

*P.K., Waynesboro, VA*

### And from a customer with a problem . . . .

"The replacement BRIDGE MASTER disk has been received. Your service is excellent and superior to other mail order houses! Please feel free to use this statement at any time."

*R.C. Meaders, Camarillo, California*

### A BRIDGEMASTER endorsement . . .

"Fantastic . . . I am very impressed (with) how smart this program is."

*R. Rakov, Syracuse, NY*

## A CALL FOR AUTHORS

### SOFTWARE ACQUISITION

Over the past two years DYNACOMP has been adding from ten to fifteen new titles to its product line each month. Also, during the same period, DYNACOMP has averaged about twice as many conversions. This pace has increased more recently and our plans are to triple the new-addition rate.

DYNACOMP gets its software from a variety of sources:

1. In-house development
2. Acquisition of titles from other companies which:
  - a) Have ceased active operations
  - b) Wish to have another marketing channel
3. Outside authors

This message is directed to the potential DYNACOMP author.

### CRITERIA

If you are the author of a good piece of software in any of the subject areas covered in the DYNACOMP catalog, you should consider DYNACOMP as a possible publisher for your work. Our criteria for acceptance are:

1. Marketability. Is this a product which provides a useful function (solves problems, is entertaining, etc.)?
2. "User-friendliness". Is the program carefully thought out, error-trapped, and easy-to-operate?
3. Documentation. Does the instruction manual provide step-by-step instructions, include background information, examples, sample sessions, etc.?

### REVIEW PRIORITIES

Quite frankly, the first thing the DYNACOMP reviewer will look at is the associated manual. From that will be formed an impression of how well documented the software is. Next the reviewer will operate the program and form an impression with respect to the "user friendly" characteristics.

### REVIEW PROCEDURE

The usual review procedure is simple. The author submits the software package for review and DYNACOMP reviews it, usually within two weeks. There are three possible review outcomes:

1. Acceptance. You will receive signed royalty agreements and a letter indicating any required changes or additional materials.
2. A statement of interest and suggested modifications to make the package acceptable.
3. A response indicating no interest.

### ROYALTIES

Our compensation policy is simple. We pay a 10-20% royalty on the gross sales, and pay this monthly (not quarterly or semi-annually as do other companies).

### MARKETING APPROACH

In the past DYNACOMP has depended on magazines for its main advertising thrust. However, the proliferation of magazines has made this approach much less effective than earlier in the business. This change, coupled with a mailing list which exceeds the circulation lists of most magazines (the first printing of our 144-page Catalog No. 28 was over 250,000 copies!) has resulted in a new marketing emphasis — direct mail. It is estimated that over 500,000 people will have read Catalog No. 28. Therefore our marketing is two-fold: magazine ads to generate interest in the catalog and large mailings of catalogs.

### DISTRIBUTION

DYNACOMP's distribution is world-wide:

- DYNACOMP has over 3,500 dealers in its active mailing list, and over 500 dealer accounts around the world.
- DYNACOMP software is being translated and marketed in French-speaking countries.
- DYNACOMP software is sold through other catalogs (for example, COMPUTRONICS, K-12 Micro Media, A.W. Peller, ASM, and many others).

### HOW MANY CAN WE SELL?

The question every author has on his or her mind is "How many of my packages do you expect to sell?" Our answer is simple and honest: we don't know! The software market is unpredictable and strewn with inflated figures and broken promises. Some programs which we think are great do not ever take hold. Some require a year of exposure. Some become hot sellers almost instantly. After more than seven years in the business, what we have learned is not to be cocky and to just do a good job in presenting software products with clear and detailed descriptions.

According to a recent survey, DYNACOMP is in the top 10% with respect to software publishing company sales, so we must be doing something right. We will try to do right by you, too. It is in both of our interests to sell your product.

For further information, contact Mrs. B. Rivers, Marketing.

### SPECIAL NOTE FOR ENGINEERS AND SCIENTISTS

The president of DYNACOMP, whose background is in nuclear and solid-state physics, along with some electrical and design engineering, is particularly fond of technical programs and reviews them himself. What he is looking for are "user friendly" and well documented programs which deal with engineering applications, physical simulations, advanced tutorials, mathematical utilities, etc. Needless to say, these submissions get special treatment!

## PUBLIC DOMAIN SOFTWARE CAUTION!

### Sour Grapes!

The public domain software appearing in this catalog was written by a variety of people, some professionals, most not. This software is not copyrighted and is generally not of commercial quality. In most cases there is NO documentation or, if there are instructions, they are on the disk itself and are either skimpy or poorly written. There are exceptions, however.

The point of this warning is to emphasize that these are not DYNACOMP programs, and we do not support them. Further, they are sold AS IS. We will replace magnetically defective disks, but cannot afford to give phone help or refunds for unsuitable programs.

DYNACOMP is supplying this material as a public service and we do not want you to become angry with us if you find these programs difficult to use or simply faulty.

### The Plus Side

This material is a great value for the price. For those who wish to experiment or just get a feel for what is available in the public domain, this is an excellent opportunity. The risk is low, and the chances of finding a useable (for you) piece of software is good. If nothing else, twenty dollars' worth of public domain software can keep you busy for quite some time!



**IMPORTANT NOTICES**

**THE DYNACOMP BULLETIN BOARD**

**DYNACOMP  
SPECIAL ORDER FORMATS**

DYNACOMP now has the facilities to provide, on special order, copies of its CP/M programs for the 5 1/4" formats shown below. The copying charge is \$5.00 per diskette. Add an additional \$3.00 to the catalog diskette price for double-density diskettes.

- |                                    |                                |
|------------------------------------|--------------------------------|
| Actrix (SSDD, DSDD)                | MAGIC (DSDD)                   |
| Avatar TC10 (DSDD)                 | Micral 9050 CP/M-80 (DSDD)     |
| Casio FP 1000 (DSDD)               | NCR Decision-Mate 5 (DSDD)     |
| Chameleon CP/M-80 (DSDD)           | NEC PC-8001A (SSDD, DSDD)      |
| Columbia MPC CP/M-80 (DSDD)        | NEC PC-8801 (DSDD)             |
| Cromemco CDOS (SSDD, DSDD)         | Olympia ETX 11 (SSDD)          |
| Cromemco w/Int'l Term (SSDD, DSDD) | Olympia EX100 (DSDD)           |
| DEC VT180 (SSDD)                   | Osborne Osmosis (SSDD)         |
| DATABUE (DSDD)                     | Otrona CP/M (DSDD)             |
| Davidge (DSDD)                     | PMC Micromate (DSDD)           |
| Digilog (DSDD)                     | Reynolds & Reynolds (SSDD)     |
| Epson Multifont (DSDD)             | Sanyo CP/M (DSDD)              |
| Epson QX-10 (DSDD)                 | Systel II (SSDD)               |
| Fujitsu Micro 16s (DSDD)           | Systel III, 200, 300 (DSDD)    |
| Group III CP/M (DSDD)              | T1 Professional CP/M-86 (DSDD) |
| H/Z Z100 CP/M (SSDD, DSDD)         | TRS-80 Model I Omikron         |
| H/Z Z100 Z-DOS 1.1 (SSDD, DSDD)    | TRS-80 FEC CP/M (SSDD)         |
| H/Z Z100 Z-DOS 2.0 (SSDD, DSDD)    | TRS-80 FEC T805 (SSDD)         |
| H/Z Z90 40 trk 1k blk (SSDD)       | TRS-80 III Hurr. Labs (SSDD)   |
| H/Z Z90 40 trk 2k blk (SSDD)       | TRS-80 III w/Mem. Merch (SSDD) |
| H/Z Z90 40 trk 2k blk (SSDD)       | TRS-80 IV CP/M (SSDD)          |
| Heath w/Magnolia CP/M (SSDD)       | TRS-80 IV Mont. Micro (SSDD)   |
| HP 125 (DSDD)                      | Teletek 40 trk (SSDD)          |
| IDEA Bitlex (SSDD)                 | Toshiba T100, T200 (DSDD)      |
| IBM PC CP/M-86 (SSDD, DSDD)        | Televideo Turbo Dos (DSDD)     |
| IMS 5000                           | Wang Maws CP/M (DSDD)          |
| ISM CP/M (DSDD)                    | Xerox 820 (SSDD)               |
| LNW-80 (SSDD)                      | Xerox 820 II (DSDD)            |
| Lobo Max-80 (SSDD)                 | Zorba 40 trk (DSDD)            |
| Lobo Max-80 512 (SSDD)             |                                |

**IMPORTANT NOTE  
FOR ATARI 800 XL OWNERS**

The Atari 800 XL is not completely compatible with the Atari 800. This means that some of DYNACOMP's software may not run on the 800 XL without the Atari translator disk. This disk is available from Atari (good luck) or DYNACOMP (\$5.00). If you have an 800 XL you will eventually need this disk!

**DYNACOMP DISCOUNT**

Remember the DYNACOMP quantity discount! Take 10% off for 3 or more programs; take 20% off for 5 or more! See the order page for details.

**APPLE MACINTOSH  
ANNOUNCEMENT**

Slowly, but surely, DYNACOMP is bringing on line Macintosh versions of many of the programs shown in this catalog. We waited to do this because, quite frankly, a 128K Macintosh is simply not capable of running our software! Now that the 512K Mac is available, the situation has changed.

To run the available DYNACOMP programs you will need a 512K Mac and Microsoft BASIC, release 2.0 or newer.

The packages available are marked with a MAC! in the margin of the description box. Try BRIDGE MASTER. You'll love the graphics!

Note: There is an additional charge of \$5.00 for all Mac packages to cover the extra media and production costs.

**TRS-80 MODEL III, 4, 4P FORMATS**  
(Read this if you have a Model III, 4, or 4P)

Here is the problem: Unlike IBM, Radio Shack has not maintained direct upwards compatibility between all of its various computer models. For example, none of DYNACOMP's TRS-80 software will run on the Model II or Model 16.

As for the Models III, 4, and 4P, there is some measure of compatibility, but it is not complete. The difficulty to you, as a customer, is that DYNACOMP cannot maintain a complete inventory for each TRS-80 model. Therefore, when we state "TRS-80" (without a Model III or 4 qualifier) we mean that the diskette sent to you will be in Model I format unless you special order (see below) another format. If you have a Model III or 4 (or 4P), here is what you need to do to use the standard DYNACOMP diskette:

**Model III:** You must format a blank system diskette and use the TRSDOS 1.3 CONVERT command to copy the DYNACOMP files from the Model I format diskette to your Model III format diskette. That is easy! TRSDOS 1.3 comes (came) with all Model IIIs.

**Models 4 and 4P:** You must run your machine in the Model III mode. We have been told by many Radio Shack representatives that there is a keyboard command which accomplishes this. However, no one seems to know what it is. As far as we can tell, you must boot your system with a TRSDOS 1.3 system diskette to do this, and use CONVERT (see paragraph above).

TRSDOS 1.3 does not come with the Model 4, but can be easily obtained through your Radio Shack dealer. It is recommended that you obtain a TRSDOS 1.3 system diskette in any case to expand the selection of software available to you.

**SPECIAL ORDER FORMATS**

If you do not want to do the CONVERT yourself, or do not want to obtain a TRSDOS 1.3 system disk to run your Model 4 in the Model III mode, DYNACOMP can specially prepare Model III diskettes for you with a service charge of \$5.00 per diskette. These diskettes will work on both Model III and Model 4 machines.

**FOR THE BEST PRICES ON EXCELLENT QUALITY DISKETTES, SEE OUR SUPPLIES SECTION. WE DO NOT SELL THE REJECTS, SECONDS, OR REDUCED SPECIFICATION DISKETTES WHICH ARE NOW BEING SOLD AT "AMAZINGLY" LOW PRICES. THEY ARE NOT SO AMAZING IN QUALITY!**

**APPLE CP/M AVAILABILITY**

In response to the many requests for Apple CP/M format programs, DYNACOMP has converted most of its CP/M software to that format. The packages which are not available are those requiring hardware-specific cursor control codes.

The not available list includes: BRIDGE MASTER, MONEY, BOOK KEEP, TYPE-RITER, TEACHER'S AIDE, PORTFOLIO MANAGEMENT, MINI-LEDGER, CUSTOMER PROFILE, DATEBOOK, TAX OPTIMIZER, PERSONAL BALANCE SHEET, all SuperSoft programs, DATA PLOTTER, BLACKJACK COACH, TRIVIA MANIA, and CASINO CRAPS. Many of these are available in "regular" Apple DOS format.

In general, you will need a full 64K of RAM and Microsoft BASIC release 4.51 or newer (unless otherwise specified) to run DYNACOMP's Apple CP/M software.

Be careful to specify "Apple CP/M" when ordering.

NOTE: Apple CP/M is treated as a special format. There is a \$5.00 extra charge for supplying diskettes in this format.

**WHAT IS THE  
8-INCH IBM 3740 FORMAT?**

Before the appearance of the 5 1/4" diskette came the 8" disk. It was originally used on IBM equipment, and IBM carefully specified the acceptable format under the code "IBM 3740". By today's standards, this is a single-sided, single-density soft-sectored format with 128 bytes per sector (256 bytes per sector would be double-density) and 77 tracks on one side of the disk.

Older 8" CP/M systems use this format exclusively. Newer 8" CP/M systems use double or quad density, double-sided format disks, but can usually read the standard IBM 3740 format. If you are unsure as to whether or not your system can read IBM 3740 format disks you can:

1. Call your dealer.
2. Call the manufacturer of your drives or computer.
3. Gamble a few dollars and buy one IBM 3740 public domain disk and give it a try.

**BEWARE THE CHEAP DISKETTE!**

During the past year, the prices of diskettes have dropped remarkably. Also, in many cases, so has the quality. It looks like several well known manufacturers have lowered their costs (in an attempt to be competitive) by cutting corners in manufacturing.

From what we can tell, it looks like some companies are not polishing the media as well as they used to. Diskettes having dull magnetic surfaces, or ones showing blemishes or diagonal (chatter) marks should be avoided; they will haunt you!

For 5 1/4" diskettes, we are currently selling only one brand: Nashua. It is not unusual for DYNACOMP to run 10,000 Nashua diskettes through its duplication facilities and turn up only one bad diskette. Nashua diskettes are not only good, but they have the smoothest surface (as discussed in a BYTE Magazine product comparison), and, as we have found, have the highest reliability of all brands tested (and we have tested quite a few!).

Yes, you may be able to find cheaper diskettes, but they are cheaper, not less expensive (in terms of what you get for your money). DYNACOMP usually does not recommend one brand over another, but you should know that our production group loves Nashua diskettes!

**IF YOU HAVE  
A JAPANESE COMPUTER ...**

Be careful!

If you have a Toshiba, Sanyo, etc., your version of Microsoft BASIC (e.g., TBASIC, SBASIC) may not be useable with DYNACOMP software! If your release number (displayed upon sign-on) is less than 4.0 (e.g., Release 2.2), then you share something in common with the old Altair BASIC (1976); age or incompatibility with the modern versions of Microsoft BASIC (release 4.51, 5.2, BASIC-80, etc.).

Another way to tell whether or not your BASIC is compatible with post-1980 Microsoft BASIC is to check on how disk files are "opened". Do you use OPEN F\$ FOR INPUT AS #1 or OPEN "I", 1, F\$? The first format dates back to Altair BASIC (1976); the second is more recent.

**OUR APOLOGIES!**

We are now running at capacity (1,500 lbs/day) in our catalog department. The DYNACOMP mailing list now exceeds 800,000 people, and we simply can't send each edition of the DYNACOMP catalog to every individual.

To be as fair as possible, we have established a priority system in which DYNACOMP customers will be placed at the front of the list for receiving catalogs. Once catalogs have been sent to our customers, we will ship to others on the list randomly until the next edition is available. Then we will start with the customer list again.

What this means is:

- Customers will receive new catalogs as they become available (two to three times each year).
- Non-customers will, on the average, receive one catalog each 18 months.

**IF YOU HAVE AN IBM "COMPATIBLE"  
OR...  
IF YOU ARE ORDERING SPECIAL  
FORMAT CP/M DISKETTES**

DYNACOMP's IBM and Microsoft BASIC programs are usually saved on the disk as tokenized code. That is, they are saved in a "language" that can be read by IBM BASIC (in the case of MSDOS) or MBASIC (release 4.51 or 5.1, in the case of CP/M). This may be likened to a form of "shorthand" writing. It takes less disk space than saving the programs in "longhand", and the programs load much, much faster.

The problem is that not all BASICs use the same shorthand. Even some of the very old versions of Microsoft BASIC (like those being sold with many Japanese computers—they must have gotten a good price on the ten-year-old software) use a different shorthand. The same is true with many of the BASICs supplied with IBM compatibles; they are not truly compatible with IBM BASIC tokenized code.

However, 99% of the time this problem can be circumvented if you order special "ASCII" versions of the products you want. When you order "ASCII", we convert the "shorthand" to "longhand" so that your BASIC will be able to load the programs without errors in interpreting the tokenized code. The service charge for this is \$5.00 per disk.



## DYNACOMP ENGINEERING CONSULTING

DYNACOMP is pleased to announce the establishment of a separate consulting group within the main organization of DYNACOMP, Inc.

In the past, DYNACOMP's staff has consulted for companies such as Xerox, McGraw-Hill, Racal-Vadic, etc., in the areas of image science, simulation, statistics, data analysis, and software engineering. Several of DYNACOMP's software products are either direct or indirect outgrowths of this work. For example, TRANSFER FUNCTION ANALYZER was originally written to analyze speaker response; FOURIER FORECASTER addresses issues raised in a commodities market assignment; REGRESSION II was designed to analyze xerographic line copy profiles; HARMONIC ANALYZER was written to study image noise; etc.

As DYNACOMP's engineering software capabilities have grown, it has become increasingly apparent that DYNACOMP has both the tools and resources to take on larger and broader commitments in the consulting profession. In particular, DYNACOMP's internal staff, combined with its contributing software authors, brings a blend of talents which can be very effective in assignments involving computer analysis.

This group is managed directly by DYNACOMP's president and founder, Dr. F. R. Ruckdeschel.

Dr. Ruckdeschel was formerly an R&D Manager and Principal Scientist at the Xerox Corporation. He has authored over 35 technical papers, as well as two texts on scientific programming. In addition, he has been awarded 14 patents.

Dr. Ruckdeschel directs each consulting assignment. He personally scopes the task, chooses the appropriate staff member(s), establishes and monitors the schedule, and reviews all reports. In this way you can be sure of high quality, efficient work which clearly addresses your needs.

Often we are able to modify existing DYNACOMP software to suit your particular situation, thereby saving in consulting time by not having to start from scratch.

The areas in which DYNACOMP has particular expertise are:

- Image science/color theory
- Electrical engineering
- Scientific programming
- Fourier analysis
- Data analysis/curve fitting
- Programming in most languages
- Statistics
- Mechanical engineering
- Mathematics
- Simulation
- Physics

If you have need for consulting in these areas, contact Ann Taylor at (716) 671-6167.

FROM (Format)*	TO (Format)*	Price per Disk or Diskette Converted
Standard 5¼-inch CP/M or MS-DOS	Standard 5¼-inch CP/M or MS-DOS	
SSDD	SSSD, SSDD, DSDD	\$10.00
SSDD	SSDD	\$20.00
SSDD	SSDD, DSDD	\$15.00
DSDD	SSSD	\$40.00
DSDD	SSDD	\$20.00
DSDD	DSDD	\$15.00
CP/M-86	MS-DOS	\$20.00
MS-DOS	CP/M-86	\$20.00
Standard 5¼-inch CP/M or MS-DOS	8-inch CP/M IBM 3740 (SSSD)	
SSSD, SSDD	SSSD	\$25.00
DSDD	SSSD	\$40.00
8-inch CP/M IBM 3740	Standard 5¼-inch CP/M or MS-DOS	
SSSD	SSSD	\$40.00
SSSD	SSDD, DSDD	\$30.00
5¼-inch MS-DOS	Apple Z80 CP/M or Apple DOS 3.3 (ASCII)	
SSDD	Apple	\$35.00
DSDD	Apple	\$50.00
Apple Z80 CP/M or Apple DOS 3.3 (ASCII)	MS-DOS	\$30.00

\* See "SPECIAL ORDER FORMATS", page 3.

SSSD = Single-Sided Single-Density SSDD = Single-Sided Double-Density DSDD = Double-Sided Double-Density

### DISK/DISKETTE FORMAT CONVERSION SERVICE

As you might imagine, DYNACOMP maintains quite a bit of software and hardware in support of its widely varied line of products. We therefore have the capability of converting files on disks and diskettes of one format to disks or diskettes of another.

The 5¼-inch diskettes which we can transfer files between are shown under the heading "DYNACOMP SPECIAL ORDER FORMATS" (see page 3). For example, we can move CP/M files from XEROX 820-II diskettes to Televideo 803 diskettes.

We can also transfer (either way) between IBM MS-DOS and IBM CP/M-86 format diskettes; between 5¼-inch CP/M (and MS-DOS) and 8-inch CP/M disks (IBM 3740 SSSD); and between CP/M (and MS-DOS) diskettes and Apple Z-80 CP/M or Apple DOS 3.3 (ASCII files only) diskettes.

The charges for this service are based on the conversion steps and the disk/diskette densities (the number of disks/diskettes) involved.

These prices include the blank disks or diskettes needed to produce the new formats.

More complicated conversions can be constructed from the above table. For example, conversion from 8-inch CP/M IBM 3740 format disks to Apple Z80 CP/M could be accomplished by 8-inch CP/M to 5¼-inch MS-DOS SSDD conversion (\$30.00), and from there to Apple Z80 CP/M (\$35.00), for a total of \$65.00 per 8-inch CP/M disk, plus \$3.50 for shipping and handling.

Turn-around time is usually less than one week. Be sure to very carefully specify the format of the disk or diskette you want converted, and the format you want it to be converted to. Your source disk(s)/diskette(s) will

be returned with the conversions. Also include a signed and dated copy of the following:

"I, \_\_\_\_\_, hereby give DYNACOMP permission to perform the indicated disk/diskette conversion. I also state that I have the right to have such format conversions made, and that no copyrights are being violated. In the case of any litigation involving this conversion, I hold DYNACOMP blameless in their service, and accept all legal and financial responsibility."

Signature: \_\_\_\_\_  
Date: \_\_\_\_\_

An 8½" x 11" copy of this statement is also available from DYNACOMP by written request.

NOTE: Disks/Diskettes sent to DYNACOMP for conversion must not be copy protected. If they are, they will simply be returned and you will be charged a \$5.00 service fee plus \$3.50 for shipping and handling. Also, please send only copies, not the originals, and pack them well so they will not be bent or otherwise damaged.

### THE COMMODORE 128

The COMMODORE 128 is a very interesting machine. First, it can be run in the C-64 mode. This means that all of DYNACOMP's C-64 software can be run on the 128!

Second, in the CP/M mode, you can "read" all of DYNACOMP's Kaypro and Osborne (double density) diskettes. Except for programs which specifically use the hardware features of the Osborne or Kaypro, you can run all of DYNACOMP's CP/M software (and we have the largest CP/M selection available).

Sorry, we do not support the third mode in the C-128; we do not think that it will have lasting popularity.



**HODGE PODGE**

(Apple, Atari, C-64, IBM, and TRS-80 only)

HODGE PODGE is a computer "happening" for children from ages 18 months to seven years and older. It is a surreptitious learning device which provides knowledge in a most enjoyable (and non-intimidating) fashion. The program consists of many cartoons, animations, and songs which appear when any key on the computer is pressed. Each key provides something different for the child to explore, from Apples to Zigzags. With an adult present the child can be told about magnets, numbers, musical notes, animals, up and down, color, and much, much more. When alone the child will be kept endlessly amused by the color, sound, and wonderful pictures displayed by HODGE PODGE. This program is a must for any family containing children and a suitable computer. Note: the TRS-80 version does not have the sound feature of the Atari and Apple versions. Apple and TRS-80 versions require 48K; Atari cassette version requires 32K, diskette version requires 48K.

NOTE: The IBM version will run in 128K and automatically adjust to whether you have monochrome or a color graphics card.

Price: \$14.95 Cassette  
\$18.95 Diskette

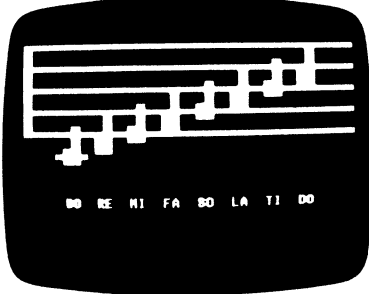
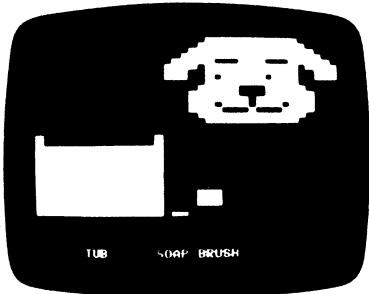

**InfoWorld**  
Software Report Card

**Kiri's**  
**Hodge-Podge**



	Poor	Fair	Good	Excellent
Performance	<input type="checkbox"/>	<input type="checkbox"/>	<input checked="" type="checkbox"/>	<input checked="" type="checkbox"/>
Documentation	<input type="checkbox"/>	<input type="checkbox"/>	<input checked="" type="checkbox"/>	<input checked="" type="checkbox"/>
Ease of Use	<input type="checkbox"/>	<input type="checkbox"/>	<input checked="" type="checkbox"/>	<input checked="" type="checkbox"/>
Error Handling	<input type="checkbox"/>	<input type="checkbox"/>	<input checked="" type="checkbox"/>	<input checked="" type="checkbox"/>

See the reviews in *Softalk* and *InfoWorld*.

**CHILDREN'S CARROUSEL**

(Apple, Atari, and Commodore 64 only)

DYNACOMP's HODGE PODGE was such a great success that we decided to produce another package aimed at the pre-school child, CHILDREN'S CARROUSEL.

CHILDREN'S CARROUSEL is composed of nine menu-selected games which have great color and sound (including the carousel and alphabet songs). The games include matching shapes, counting, letter recognition and more. It has been "field tested" with many children. We are very proud of this one!

Price: \$19.95 Diskette

NOTE: The IBM version requires 128K. A graphics card is supported, but optional. A 320K or larger disk drive is needed.

**Review of**  
**CHILDREN'S CARROUSEL**

by Duane Sandul, Times Staff Writer  
(Reprinted with permission. All rights reserved.  
April 14, 1984 edition. Computer Screening column.)

CHILDREN'S CARROUSEL, \$19.95, Dynacomp, Inc., 1427 Monroe Avenue, Rochester, N.Y. 14618, for Apple and Apple compatible:

Nonreading children from 2 to 6 will love to run this musically motivated program. There are nine games designed for children to use on their own, but you will probably want to go through the games once with each child to be sure he understands what to do.

The object of the program is to teach various skills in a colorful and interesting manner. There are no scores kept and if any answer is wrong, only a buzz is given.

When the child answers correctly, a portion of the Carousel Horse appears. When the correct number of horses (different for each game) are completed, the Carousel turns and plays.

The skills taught are: alphabet recognition, co-ordination in the use of computer keys, shape recognition, shape comparison, shape differentiation, color differentiation, letter matching, and numbers.

Each game is unique. For the alphabet-recognition game the "Alphabet Song" is played, and with each note the appropriate letter appears. Then, in letter recognition and matching, the alphabet is presented in random order. Four letters appear on the screen, and the child is to press a key which matches any of these letters. The keys are supposed to be laser guns, and when the correct key is pressed the letter explodes, disappears, and is replaced by another.

Preschool children will find this an enjoyable way to learn, and parents will have bought a program that their children will be able to use without too much supervision.

CHILDREN'S CARROUSEL is a great present for a young child, and may soon outsell even DYNACOMP's HODGE PODGE!

**InfoWorld**  
Software Report Card

**Children's**  
**Carousel**

	Poor	Fair	Good	Excellent
Performance	<input type="checkbox"/>	<input type="checkbox"/>	<input checked="" type="checkbox"/>	<input checked="" type="checkbox"/>
Documentation	<input type="checkbox"/>	<input type="checkbox"/>	<input checked="" type="checkbox"/>	<input checked="" type="checkbox"/>
Ease of Use	<input type="checkbox"/>	<input type="checkbox"/>	<input checked="" type="checkbox"/>	<input checked="" type="checkbox"/>
Error Handling	<input type="checkbox"/>	<input type="checkbox"/>	<input checked="" type="checkbox"/>	<input checked="" type="checkbox"/>

**SCREEN DOLLS**

(Apple only)

SCREEN DOLLS is a creative fantasy toy designed specifically for children (ages 3-7). There is no aggression, shooting, etc.; just music and friendly fascination. No reading is required, and any input is accepted. The clothing and accessory choices are shown pictorially on the screen and each is presented in turn. Press a key, and that item is added to the doll.

Your child may experiment with a red top and white shorts with tennis shoes and glasses. Each choice is rewarded with a melody. Over one-million combinations are available.

Use SCREEN DOLLS to introduce your child to computers, pattern recognition, and decision making.

Requires 48K of RAM. A color monitor is suggested for best effect.

Price: \$19.95 Diskette

Sample display:

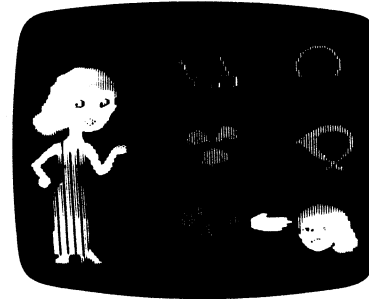

**MATH WHIZ QUIZ**

(Atari only)

MATH WHIZ QUIZ is a series of lessons in math for preschool through grade school children. Sounds and graphics are used in counting and elementary addition and subtraction exercises. The user can easily choose the difficulty of the lessons which progress through 12 levels up to multiplication and division. Correct and incorrect answers are clearly indicated with graphics displays. Problems are repeated until the student either supplies the correct answer or requests the Atari to provide the answer.

Requires 16K (Cassette), 24K (Diskette).

Price: \$13.95 Cassette  
\$17.95 Diskette

Sample display:

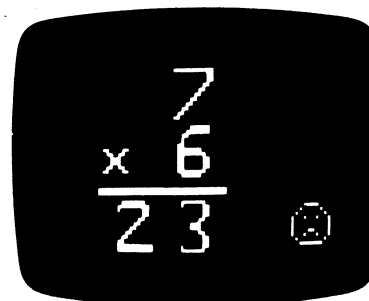

**NUMBER CIRCUS**

(Apple only)

NUMBER CIRCUS has one goal in mind — to motivate children 4-6 in the learning of counting, addition, and subtraction. The program combines the graphics, color, and sound of the Apple to capture your child's interest and teach. That's it!

Requires 48K, and a color display.

Price: \$16.95 Diskette

Sample display:

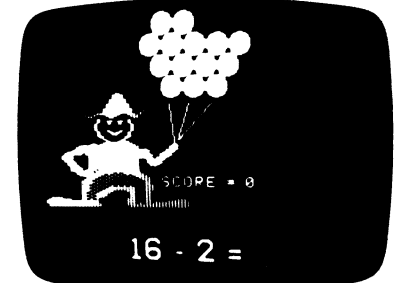

**TINY TUTOR**

(Commodore 64 only)

TINY TUTOR introduces tots to computers the right way; by mixing education and fun.

TINY TUTOR, a simple math program aimed at children from 3 through 7, presents easy addition and subtraction problems in clear, graphic style. Numbers are presented both numerically and graphically by small trolley cars that move with a delightful "chug-a-chug"; three trolley cars plus four trolley cars equals seven cars on the track! All problems are shown in this friendly fashion which immediately puts children at ease; the child simply counts the trolley cars to arrive at the correct answer. The problems range in complexity from 1-0 to 10+9 and TINY TUTOR keeps tabs on the child's progress in order to limit the complexity according to ability. TINY TUTOR is also a patient program; there is no time limit in which a problem must be answered. A question mark simply flashes prompting your child's entry of the answer. Correct answers are rewarded with cheerful sound effects and the arrival of a new problem "train". If three incorrect answers are given to a problem, the answer is simply provided and the next problem appears. At the end of ten problems, the child's score is graphically and numerically represented; 10 out of 10 receives an additional sound-effect bonus.

Price: \$19.95 Diskette

Sample display:

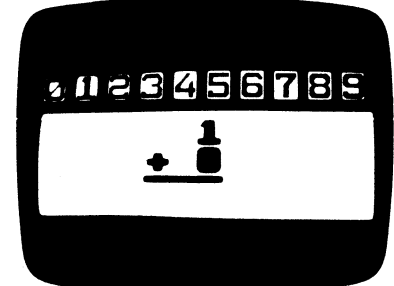

**TIME MASTERS™**  
(Atari only)

TIME MASTERS™ is an entertaining way of learning time concepts for children ages 3 to 10. It is especially helpful for children having difficulty mastering clock time. Besides teaching children how to read clocks, this program also teaches days of the week, months of the year, and holidays. Each month of the calendar has a picture illustrating the season as an associative aid for the child. Holidays are highlighted on the calendar; selecting the day displays a picture of the holiday on the screen. Moving the hands of the clock makes the date in the calendar change as midnight is passed.

There are three playing modes in this educational game: a self-learning mode which children can use to learn by experimenting with the clock and calendar; a clock-test mode; and a day-of-the-week tester. Each test has its own series of changing rewards for right answers. After a short test, the child gets to take a break by playing a colorful music game. A greater number of correct answers earns a greater amount of play time. The program is self-paced and designed to minimize the need for reading skills and outside assistance.

Requires a joystick (or a trackball) and a disk drive.  
Price: \$19.95 Two Diskettes

**PLANET MATHEMATICA**  
(Commodore 64 only)

PLANET MATHEMATICA is a powerful combination of a fast-action video game and a math education program. This combination, while blending the excitement of computer gaming with the effectiveness of computer-based education, leaves the accent squarely on the entertainment side in order to hold the interest of the student. The sole object of the game is to achieve the highest score possible by destroying alien invaders. The math portion itself becomes a competition against time to get back into the game with as much time left as possible. Each math problem is carefully presented in order to show the student that larger multiplication or division problems are actually solved by breaking them into smaller, more manageable problems. Unlike most other math educational programs that simply ask for the answer to a complex problem, leaving the method of solution up to the student, PLANET MATHEMATICA actually presents all of the intermediate steps of long division, multiplication, addition, and subtraction. These features make PLANET MATHEMATICA a truly educational program that students will find difficult to resist.

Price: \$19.95 Diskette

Sample display:



**Did you know . . . ?**

In the March 1983 issue of SOFTLINE, the following DYNACOMP programs received first place votes: FROG MASTER, PERSONAL FINANCE SYSTEM, SUBMARINE COMMANDER and VALLEY OF THE KINGS.

**Review of SERENDIPITY**

by Duane Sandul, Times Staff Writer  
(Reprinted with permission. All rights reserved.  
April 21, 1984 edition. Computer Screening column.)

SERENDIPITY, \$19.95, Dynacomp, Inc., 1427 Monroe Avenue, Rochester, N.Y. 14618, for Apple and Apple compatible:

This is a nine-game educational program for children. The alphabet, numbers, and colors are presented in an easy-to-understand manner that young children will quickly grasp.

The alphabet and numbers segments are geared to the pre-school child, while learning colors and a game of math invaders are for older children.

This is a comprehensive beginning educational program that offers a lot for a small price.

**SERENDIPITY**

(Apple and Commodore 64 only)

This is the third in DYNACOMP's series of educational packages for young children (the first two are HODGE PODGE and CHILDREN'S CARROUSEL). SERENDIPITY was written by a teacher and field tested in an elementary school. It consists of the following nine subprograms:

- |                          |                        |
|--------------------------|------------------------|
| 1. Alphabet Match Patch  | 6. Math Invaders       |
| 2. Number Match Patch    | 7. Pinpoint            |
| 3. Number Counting Patch | 8. Estimation Baseball |
| 4. Waffle                | 9. Mineshaft           |
| 5. Sour Apple            |                        |

Each sub-program is called from a menu. All programs are friendly, have built-in instructions, and are virtually crash-proof.

SERENDIPITY was written with children in mind. After minimal experience, the child usually becomes comfortable with the format of this package. Each program follows a consistent system of entering and exiting. Most of all, the package is fun. The programs tackle difficult concepts in a great variety of ways. Requires 48K.

Price: \$19.95 Diskette

Sample display:

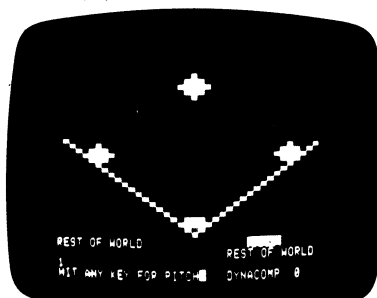

**CHILD'S PLAY I**  
(Apple only)

CHILD'S PLAY I is the fourth number in DYNACOMP's preschool education collection (see also HODGE PODGE, CHILDREN'S CARROUSEL, and SERENDIPITY). CHILD'S PLAY I contains four programs:

- SHAPES PRIMER - Helps teach young children how to identify shapes that are smaller than, larger than, and different from other shapes.
- NUMBERS PRIMER - Three activities to help children learn to count to ten.
- ANT MAZE - Guide Artie the ant through five simple mazes to his reward of a sugar crystal snack and a short song. Helps teach directions and simple keyboard use.
- DRAWING FUN - A "just for fun" activity that turns the screen into a magic slate.

CHILD'S PLAY I has great graphics and sound. Requires 48K and game paddles.

Price: \$19.95 Diskette

**BARNEY O'BLARNEY'S MAGIC SPELLS**  
(IBM only)

BARNEY O'BLARNEY'S MAGIC SPELLS will improve your child's spelling and math reasoning ability. Barney O'Blarney, a rascally little leprechaun, will lead your child on a chase through the forest in search of the famous pot of gold. Barney gives clues about the location of the pot of gold in reward for correctly spelling his words. When Barney's pot of gold is found, he hides another and the adventure begins again. Music, graphics, and animation will entice your child to play for hours. A special reward awaits the child who learns all 500 spelling words.

The story pamphlet (included) sets the scene. The whole family can join the fun as Barney O'Blarney will keep track of three different players. The game records each player's progress and the number of pots of gold each has found. It automatically keeps pace with the

**AMERICAN FLAGS**

(Atari only)

AMERICAN FLAGS is a colorful and educational game that teaches you to identify the state, provincial, national, and territorial flags of North America. Can you recognize your local flag?

These flags make a fascinating display of design and color. Some of the flags of Canada have their origin in England, Scotland, Ireland, and France and some feature fleurs-de-lis or the Union Jack. Most of the flags of the United States have their origins in military banners and are often used with a yellow or fringed edge or a lance-head. Do you know which state flags feature Indian emblems, the Big Dipper constellation, a bear, an eagle, a pelican, or an anchor?

To get to know these important symbols, you can enter the name of a state or province and display its flag on the screen with some information about the area. Each flag is drawn on a high-resolution full-color screen, with some using as many as ten different colors and shades!

Also, you get a full-screen color map of North America indicating the area represented by the flag. This will give you a graphic illustration of distance and the contrast in size between areas, such as tiny Rhode Island and huge Alaska. You'll also hear some of the more popular state and provincial songs and the national anthems in their entirety, all with four-voice arrangement.

You can take a quiz on all 76 flags, or only the flags of Canada or the United States. There are over 300 clues to

**SHAZAM ELECTRIC COMPANY**  
(IBM only)

SHAZAM ELECTRIC COMPANY teaches a basic consumer skill: how to read a utility meter. This program simulates ten different kinds of meters and challenges the student to read them accurately, record each setting, and calculate the bill for each meter.

SHAZAM is designed primarily for use in secondary-level math classes; it reinforces basic calculator and record-keeping skills. And, before the end of each session, feedback is given on the accuracy of all calculations.

A Teacher's Log is maintained. It contains a color-coded summary of each student's performance and the readings and calculations for the meters used. These are useful for tracking student progress and identifying skills which may need help (e.g., subtraction, multiplication, rounding of decimals, reading the meter, etc.). A sample meter face, reporting form, and sample screen displays are provided for use as advance organizers.

SHAZAM is menu driven and, therefore, very easy to use.

SHAZAM requires an IBM-PC or compatible computer, PC-DOS version 2.0 or MS-DOS version 2.02 or higher, 196K of RAM, BASICA version 2.0 or higher, one 360K disk drive, and a high-resolution graphics monitor and adapter board. Color capability and an Epson MX-series printer are optional.

Price: \$29.95 Diskette

ability of the player, presenting words that are neither too easy nor too hard. The word list supplied covers grades 1 through 7, but you can easily add your own words. The parent (or teacher) can control options such as music and preview time, so that the student can get the kind of spelling practice you want and still have fun while learning.

Requires one floppy drive and a color graphics card, DOS 1.1 or 2.0.

Price: \$29.95 Diskette

help you along; mottoes, nicknames, locations, flowers, populations, and capitals. Where is "Wild Rose Country", the "Land of Enchantment" or Guam? Columbus is the capital of which state? What is a peony? There are no time limits and five turns at each flag, but you'll need to know how many N's in Pennsylvania: spelling counts.

Also included are the flags of eight territories and Trust Territories of the United States, and three southern neighbors: The Bahamas, Cuba, and Mexico.

Requires 48K. A color monitor is recommended!

Price: \$18.95 Diskette

**AN EXCERPT**  
**from an award announcement**  
(Family Computing Magazine May 15, 1985)

"It gives me great pleasure to inform you that you [DYNACOMP] are among the publishers cited by Family Computing for producing outstanding educational software. To you and these other publishers, Family Computing's 'Critic's Choice' awards will be presented at the June CES."

Shirrel Rhoades, Vice Pres./Publisher



**CAPITAL ATTACK**  
(Commodore 64 only)

The purpose of this game is to teach students the names and correct spellings of the states and their capitals.

Earth is under attack by aliens from the planet Xenon. Wave after wave of interplanetary ballistic missiles are being launched at the United States. As commander of defenses, your job is to defend all of the 50 states and destroy the Xenon missile.

Powerful anti-ballistic missile bases are located right outside each of the capitals. When a missile is detected heading toward a state, you must type in the name of the capital of the state in order to launch your ABMs and destroy the Xenon missile.

Don't delay! There is only a limited amount of time before the warhead hits. As you watch the clock tick down on the missile approach, you must quickly think of the answer that will launch the counter-attack and save the state.

Price: \$14.95 Cassette  
\$18.95 Diskette

Sample display:

TIME TO IMPACT- 0:08

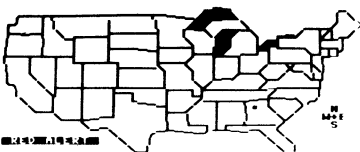

**GAME TIME CLASSROOM STATES BIBLIOGRAPHY**  
(Commodore 64 only)

GAME TIME CLASSROOM - STATES BIBLIOGRAPHY is an educational game for one or two players. The computer asks questions about the 50 states and points are awarded according to correctness and speed. The game is therefore educational and competitive (and fun to play!). Many of the questions are difficult, but after a while the student will learn and achieve higher scores.

Requires one joystick (for one player) or two joysticks (if two play).

Price: \$14.95 Cassette  
\$18.95 Diskette

Sample display:



**GAME TIME CLASSROOM PRESIDENTS**  
(Commodore 64 only)

GAME TIME CLASSROOM - PRESIDENTS is an educational question-and-answer game for one or two players. The categories covered for a given president are:

Vice President	Sequence and Party
Years in Office	Date and Place of Birth
Nickname	Date of Death & Burial Place

The answers are given in multiple-choice format with a time limit for responding. Points (dollars) are awarded for the correctness of response and speed. This program offers an enjoyable approach to the task of learning and remembering historical data. (Who was Hannibal Hamlin?)

Requires one joystick (for one player) or two joysticks (for two players).

Price: \$14.95 Cassette  
\$18.95 Diskette

Sample display:

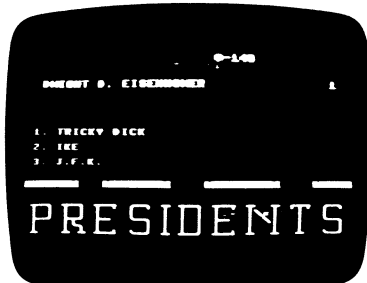

**STATES, CAPITALS, AND NICKNAMES**  
(Atari only)

STATES, CAPITALS, AND NICKNAMES reviews these three items for each of the fifty states. The student can choose either a written or map-aided format, the type of questions to be asked, and the number of questions. There is also a multiple-choice option. When done, the student is graded and may review any missed questions. The program is very friendly and is both fun and educational for all ages. STATES, CAPITALS, AND NICKNAMES uses Atari graphics and requires 24K for cassette or 32K for diskette.

Price: \$12.95 Cassette  
\$16.95 Diskette

Sample display:



**NATIONAL FLAGS**  
(Commodore 64 and Atari only)

NATIONAL FLAGS is a colorful and entertaining way to be introduced to the national flags of nations across the world.

The main function of flags is social communication. They represent or identify the existence, presence, origin, authority, possession, loyalty, glory, beliefs, or objectives of an entire nation. Many countries suggest through their symbols the importance of agriculture, industrialization, flora, fauna, dynasties, unity, liberty, justice, democracy, progress, victory, the sun, the sky, the sea, or religion as the hope of the future.

To get to know these important symbols, you can display a flag plus a world map on the screen and read the accompanying information about the nation's currency, capital, and population. You can take a quiz, either on the flags of the nations of the world, or one specific region: Africa, the Americas, the Middle East, Europe, or Asia-Pacific. You'll be surprised how colorful and unusual some of these flags are! The world list, including 168 different nations, will challenge even the most advanced student of geography.

NATIONAL FLAGS is impressive in terms of its graphics, the amount of information contained in the program, and its educational value.

Requires 48K.

Price: \$25.95 Cassette  
\$29.95 Diskette

Note: Atari version NOT available on cassette.

Sample display:



**ADDITION TO NATIONAL FLAGS**

FLASH! We have added a new feature to the Atari version of NATIONAL FLAGS: the national anthems for 121 countries (disk version only). Now you can see the flag, learn vital information, and hear the anthem!

**MATH INVADERS™**  
(Apple only)

Using MATH INVADERS™, children can learn elementary math facts with better retention than by following textbooks. Among the features provided are:

- Speed factor setting
- Controlled reinforcement
- Developmental sequence drills
- Drill file maker
- Management reporting (record keeping)
- Game result structure
- 32 drills

MATH INVADERS was developed by an educator with the goal of making math drill enjoyable and more effective. It has been field tested for two years, modified, and

**NATION**  
(Apple only)

NATION is a contemporary strategy game that puts you at the head of your own island nation. Your decisions are the law-of-the-land, dictating whether your nation grows into an industrial giant or falls into economic chaos beneath the feet of invading armies. NATION provides you with the once-in-a-lifetime experience of governing millions of people.

By controlling agriculture, industry, health care, housing, the military, and the national treasury, you try to develop the most prosperous nation while keeping your opponent from doing likewise.

Waging war, blockading your opponent's coastline, building industrial empires, promoting the national defense, and taxing your people are just some of the many options you can choose from during each turn of the game. Providing a food supply, houses to live in, and hospitals to heal in are examples of the responsibilities needed to maintain the happiness of your people. Greedy pirates and Nature's deadliest weapon, hurricanes, add to the complexity.

As well as exciting head-to-head competition, NATION provides a challenging solitaire game. Four different computer opponents, each employing distinctive strategies, provide hours of thought-provoking enjoyment.

Colorful HI-RES graphics with easily recognizable symbols, fast play, a thorough, easy-to-understand instruction booklet, and the friendliest input system ever created for a strategy game make NATION a real winner!

Requires 48K. Joysticks are optional.

Price: \$19.95 Diskette

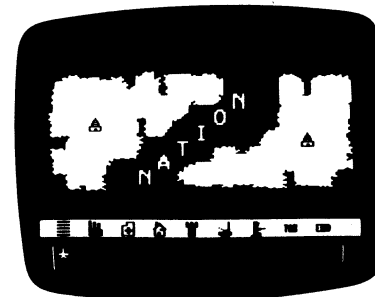

now is available for distribution through DYNACOMP. Here are some of the endorsements:

"Our students, mostly third and fourth graders, have been using MATH INVADERS and enjoy it very much. It is beginning to have a 'snowball effect,' which makes us extremely pleased."

Jim Miller, Principal  
El Paso, TX

"MATH INVADERS is the key software package we used in establishing our elementary level computer labs. It has proven to be reliable, friendly, and effective."

Cindy Jankowski  
Greece, NY

MATH INVADERS includes a teacher's manual and laminated instruction sheet.

Price: \$44.95 Diskette

## EDUCATION - GENERAL

### ELIZA II

(Available for all computers except Commodore, North Star (BASIC) and Atari)

This is the well known artificial intelligence program which was originally written by Joseph Weizenbaum for the large computers at MIT. ELIZA simulates a session with a psychotherapist who analyzes your comments and responds accordingly. This program has gained particular recognition for its surprising ability to provide realistic responses to your statements, and has often been referred to in reference to Turing's test for human intelligence.

DYNACOMP's version of ELIZA is unique in that several new features have been added without compromising the quality of the original. For example, the range of the dialogue has been increased and the responses are less patterned. The entire exchange may be saved and recalled from disk. You can save and continue sessions later. You may add in your own code (the program is in BASIC) to extend ELIZA's abilities. And more! However, don't take ELIZA's responses too seriously. After all, it's only a computer (or is it?)!

Price: \$19.95 Diskette  
\$22.45 Disk

Requires 48K.



### YOUR FIRST ATARI DISK

(Atari only)

YOUR FIRST ATARI DISK is a disk full of educational programs. Included are:

- An autocataloging program.
- An autobooting program.
- A sound-demonstration program and tutorial.
- A new and unique hangman program with five 100-word lists, letter shooting, and a maze.
- A graphics demonstration.
- Three programs for math, alphabet, and stick art.

The autocataloging and autobooting programs may be copied onto your own disks. You may customize your own disks by having the catalog autoboot, then select your program by catalog number.

The hangman game is not the simple variety you've seen elsewhere. This version contains five word lists (each containing 100 words) of increasing difficulty. You may also build your own word lists. Also, the game has been made a bit more intricate by adding joystick control, an energy maze, passwords, etc.

The remaining four programs are interesting on their own, but more importantly, form frameworks for more elaborate programs which you may write!

Requires 48K and one disk drive.

Price: \$29.95 Diskette

## EDUCATION - GENERAL

### APPLE INTRODUCTION

(Apple only)

APPLE INTRODUCTION provides 31 different programs intended for use by students in grades 3 through high school.

The programs may be classified into 3 major areas. First, there are those which provide instruction in the use of the Apple computer. These include instruction in interpreting error messages, how to solve minor problems, practice in finding keys via touch typing, using the various keys to produce art and music, and familiarization with certain computer vocabulary. Second, there are programs which use formulas (area, compound interest, classifications of triangles according to side measurements, making change, etc.). Finally, there are quizzes. Included here are arithmetic (whole numbers, fractions, decimals, percents), word problems, English grammar, and spelling (applicable to foreign-language study).

Once a program is selected from the menu, the diskette may be removed. Therefore, in a classroom situation, each student does NOT need his own diskette.

Several of the programs are done in color, and the ART program provides for a paper copy of the picture drawn if a printer is available.

Price: \$19.95 Diskette

### SUMMER OLYMPICS 1984

(Apple only)

SUMMER OLYMPICS provides practice in determining percentages on the basis of information read from a chart, rounding those percentages to the nearest whole number, and comparing percentages. It has been successfully used in grades 5 through high school.

The charts provide a high level of interest for students. You are first shown a list of all countries that won medals in the 1984 SUMMER OLYMPICS, including the number of gold, silver, bronze, and total medals received. There is a quiz (randomly generated) about the 20 countries that won the greatest number of medals. The percentage of questions answered correctly is given at the end of the set. You may also choose a specific country to be quizzed on. In this case, the computer chooses a second country and a set of comparison questions is generated about the two of them. There are numerous combinations of questions so that repetition is kept to a minimum.

Price: \$19.95 Diskette

### WORLD GEOGRAPHY

(Apple, Atari, and TRS-80 only)

WORLD GEOGRAPHY is a graphical educational tool for teaching the locations, capitals and largest cities of states and provinces within the U.S. and Canada, as well as countries within North America, South America, Central America and Europe. For example, the outline of Europe and its countries may be displayed. The student must name the country with the flashing border. If the answer is correct, the student goes on to being questioned about the name of the capital and/or largest city. If he/she gets it wrong, there is another chance, after which the correct answer is shown. Options are available to review the correct answers, see the score and be tested on the questions gotten wrong. Use WORLD GEOGRAPHY to enhance your child's knowledge or to fill in that gap.

Requires 48K.

Price: \$12.95 Cassette  
\$16.95 Diskette

The Atari version does not contain the states quiz (see STATES, CAPITOLS and NICKNAMES).

## EDUCATION - GENERAL

### GERMAN and RUSSIAN PRACTICE

(Apple only)

Side one of this disk contains German sentences and words in a hangman game. Side two contains Russian with a simple method for learning the Cyrillic alphabet.

Price: \$27.95 Diskette

### SPANISH READER - ALICIA

(Apple only)

With this advanced Spanish program you can study a Spanish translation of *Alice in Wonderland*. It uses a word-by-word test method along with the special hi-res screen alphabet.

Price: \$27.95 Diskette

### EARL'S WORD POWER

(Apple only)

After teaching a variety of homonyms, Shakespearean plays are used to test the students' knowledge. The programs help students of English from the fourth grade to the adult level.

Price: \$27.95 Diskette

### MOTHER GOOSE RHYMES

(Apple only)

These programs allow the child in the second or third grade to practice spelling and memorization in a way which is fun. *The Night Before Christmas* and *Paul Revere's Ride* are included along with many Mother Goose rhymes.

Price: \$27.95 Diskette

### LESSONS IN ALGEBRA

(Apple only)

This tutorial, written by a practicing algebra teacher, teaches the beginning elements of algebra at the junior high school level.

Price: \$27.95 Diskette

## WATCH THE MAGAZINES FOR NEW DYNACOMP ADVERTISEMENTS AND REVIEWS

### EARTH SCIENCE SERIES

(TRS-80 III/4 only)

Twelve programs in one! ... designed to supplement any junior or senior high Earth Science curriculum. EARTH SCIENCE SERIES covers Earth history, seasons, meteorology, basic chemistry, gradient, heat energy lost or gained, latitude and longitude, stream erosion, water budget, and percent error. Also included is a special Lab Aid program to assist students in the calculation and graphing of 21 Earth-science-related values.

Price: \$79.95 Diskette

## EDUCATION - SCIENCE/MATH

### WEATHER FRONTS

(Apple only)

Everyone talks about the weather, but we've done something about it! And, judging from WEATHER FRONTS' popularity with schools across the country, teachers agree with *Creative Computing's* endorsement that "the graphic illustrations... are excellent" (April, 1981). WEATHER FRONTS is an ideal introduction to the structure and characteristics of weather activity. Full-color cross-sectional diagrams help students retain the text material. WEATHER FRONTS includes tutorial, test, and review options. A Lesson-Tutorgraph™ for junior high to adult.

Price: \$24.95 Diskette

Sample display:



### DINOSAUR DAYS

(Apple only)

Begin with an irresistible topic, add color and animated graphics, and kids will love learning about dinosaurs. DINOSAUR DAYS contains two disks full of information on dinosaurs and their environment. Topics covered include: fossils, dinosaur classifications, extinction theories, and notable facts on favorite dinosaurs. Each disk has a graded test, review options, and the package includes worksheets, tests, and activities. A Lesson-Tutorgraph™ for elementary-level children.

Price: \$39.95 Two Diskettes

Sample display:

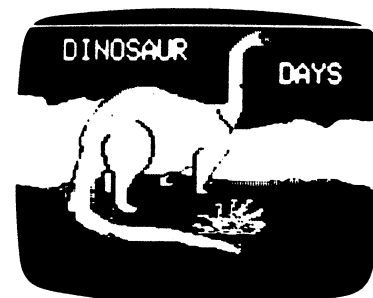

**THE SCIENCE PROFESSOR COLLECTION**

(Pet/Commodore and Apple only)

THE SCIENCE PROFESSOR is a collection of ten separate programs on the following subjects:

1. **INSECTS** - Shows how insects grow and change and in what ways they are alike.
2. **MACHINES** - Familiarizes the student with the different types of simple machines and how they are useful.
3. **BONES & MUSCLES** - Shows the major bones in the body and the different types of muscles. Also acquaints the student with bone marrow, cartilage and ligaments.
4. **MATTER** - Shows the difference between the three forms of matter and discusses heat, energy, gravity, and recycling.
5. **EARTH'S ATMOSPHERE** - Teaches about the composition of our atmosphere, air pressure, differences in temperatures over land and water, and about acid rain.
6. **SOLAR SYSTEM** - Teaches about the nine planets, seasons, orbits, and much more.
7. **PLANET HOPPING** - Teaches the student a little bit about each planet and the other bodies found in our solar system.
8. **EARTH'S ROCKS** - Shows the three types of rocks, how they are formed, and the differences between them.
9. **GREEN PLANTS** - Shows the food-making process in green plants and its importance to the world.

10. **EARTH'S RESOURCES** - Teaches about renewable resources, fuel from green plants, and conservation.

THE SCIENCE PROFESSOR is intended for children with at least a fourth-grade reading level, and is applicable through grade 9. Each program concludes with the **ARROW GAME** (like **SPACE INVADERS**) which tests how well the student has learned the lesson. Also provided is a study sheet (which can be printed) showing the questions answered incorrectly.

Each program requires 16K of memory. A printer is supported but is optional. Compatible with 2000/4000, C-64, and Apple.

Price: \$ 99.95 Commodore  
\$199.95 Apple (10 disks)

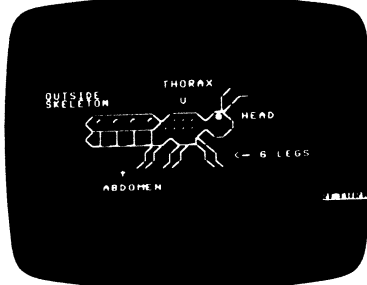

**THE PEP PREP SERIES**

(Pet/Commodore only)

THE PEP PREP SERIES is a collection of 16 programs aimed at elementary education. It was originally designed to help students prepare for the third grade New York State PEP Test, but has been found to be generally useful in both elementary and remedial education. The 16 programs and their objectives are:

- **Fractions** - From a geometric shape, the student will be able to tell what fractional part of the whole has been shaded in by typing in the numerator and the denominator that corresponds to that figure.
- **Grid Location** - The student will be able to determine the X and Y coordinates of a randomly placed point on a grid.
- **Odd & Even** - The student will be able to determine whether a number is odd or even.
- **Bar Graphs** - From a vertical bar graph the student will be able to determine those values which are negative.
- **Skip Counting** - Given a pattern of numbers, the student will be able to tell what number has been added to each of the previous numbers and, by doing so, determine the next in the series.
- **Inequalities** - The student will be able to complete an inequality by correctly typing in the greatest or smallest value (depending on what is asked for).
- **Subtraction** - The student will be able to subtract a 3-digit number from another 3-digit number by renaming one group of ten as ten ones.
- **Factors** - From four choices, the student will be able to find the number that is NOT a factor of a given product.
- **Ordinal Numbers** - The student will be able to name the ordinal position of an object in a line of ten characters both in numerical and written form and will also be able to name the ordinal position that follows a given ordinal number greater than eleventh and less than 100th.
- **Place Value & Expanded Notation** - The student will be able to identify the ones, tens, hundreds, and thousands places in a four-digit number.

- **Symmetry** - The student will be able to determine which geometric shapes show lines of symmetry and which shapes are symmetric.
- **Tables** - The student will be able to count tally marks from a table.
- **Rounding** - The student will be able to round off a 2-digit number to the nearest ten.
- **Probability** - The student will be able to choose the probability of an event happening in either of two forms: 3/4 and 3 chances in 4.
- **Perimeter** - The student will be able to calculate the perimeter of a geometric shape.
- **The Metric System** - Given a paragraph, the student will be able to determine which Metric unit should be used.

Each program begins with a tutorial and is followed by a graded test. Besides teaching elementary math skills, PEP PREP is useful as an introduction to the use of computers and computer keyboards.

Each program requires 16K. Commodore 2000/4000 and C-64 compatible.

Price: \$99.95 Diskette

Sample display:

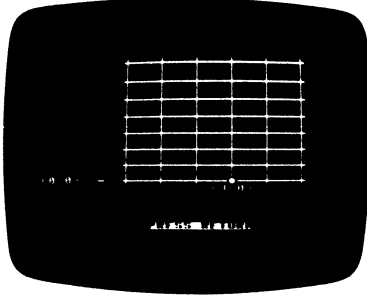

**WEATHER FORECASTER**

(Apple and IBM only)

Map area covered:



WEATHER FORECASTER is a statistically-based analysis package that will predict average temperatures (30-year means) for any day of the year as well as heating degree days, cooling degree days, number of frost free days, growing seasons, and corn heat units. It will give you a 3-day weather forecast based on current time factors. In the long term it will simulate a 3-day weather forecast any day of the year for your location, including 3-day weather maps.

You are not limited to ground level predictions. You can get an average forecast of conditions at the intermediate upper air levels of 1,000, 850, 700, and 500 millibars. If you have current upper air readings from the weather service you can analyze the upper air using these parameters (and check on the weather service!).

WEATHER FORECASTER can be used for regions within the following geographic coordinates: 0° to 90° North latitude and 0° to 180° West longitude.

Predictions displayed include:

- Cloud cover/type/height
- Wind direction and speed
- Weather movement (direction and speed)
- Average temperature and deviation from long term average
- Air mass type
- Storm warnings

Basically, you supply some current information, and WEATHER FORECASTER will give you a projection.

Teachers: This is an ideal program for classroom use!

Requires 48K of RAM (Apple), or 128K of RAM (IBM).

Printer requirements: Apple: MX-80 or Star-Gemini 10X  
IBM: 80-CPS matrix or Star-Gemini 10X

Price: \$39.95 Diskette

**SHORE FEATURES**

(Apple only)

Would you know a *berm* if you saw one? Here's another unique and interesting subject which lends itself perfectly to the tutorial format. The program familiarizes students with the geographical features of shores and beaches. Graphic illustrations highlight the typical location and characteristics of each feature. A test is provided and graded by the computer. **SHORE FEATURES** is an ideal supplement to your current Earth Science curriculum. A Lesson-Tutorgraph™ for junior high to adult.

Price: \$24.95 Diskette

**TEACHER'S AIDE**

(Available for all computers except North Star)

TEACHERS AIDE is a learning tool meant to be used for grades 1-6 mathematics. There are drills on addition, subtraction, multiplication and division. The child has the choice of five levels of difficulty for each procedure, and there is the option to drill and display each step in long division and multiplication. This is a valuable way to demonstrate the steps involved in division and multiplication and provides the student with insight into the processes involved in these operations. The problems are displayed in large block graphics for easy readability. Does not run on Commodore 64.

Requires 24K.

Price: \$13.95 Cassette

\$17.95 Diskette

\$20.45 8" CP/M Disk

Sample display (Atari):



**CONQUEST**

(Apple only)

CONQUEST provides an easy way for students to learn the shapes, names, and capitals of the 48 contiguous states. Up to four people may play. For the single player, the computer is the opponent. You capture states by naming the state name and capital of states neighboring ones already captured. Strategy is important since you can block your opponent.

CONQUEST includes both graphics and sound, and is a very painless way to learn U.S. geography.

Price: \$15.95 Diskette

Sample display:

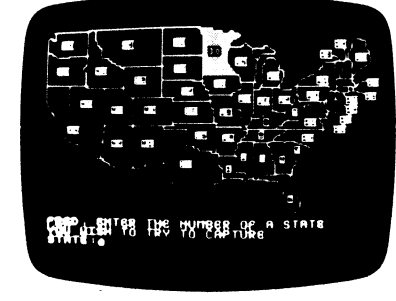



**ADVANCED MATH GRAPHICS**

(Apple and IBM only)

ADVANCED MATH GRAPHICS (AMG) is a menu-driven collection of seven programs which graphically (HI-RES) demonstrate many of the functions and concepts encountered in advanced high-school and beginning college mathematics.

The subject areas covered are:

- Polynomial functions
- Rational polynomials
- Trigonometric functions
- Polar plotting
- Conic sections (2D)
- Conic sections (3D)
- Fourier series

For each of the seven choices there is a variety of functions which can be plotted, and you can choose the coefficients which go with each functional form. Also, you may vary the screen parameters: size of each axis; tic distance; X, Y increments; multiple functions (on top of one another); etc.

The three-dimensional conic section plots are particularly interesting to view, and the Fourier series approximations to square waves (and other functions) are very informative.

Every step in AMG is menu-controlled and error trapped. Each graph can be saved on disk for later recall. Includes an excellent 32-page instruction manual.

Price: \$39.95 Diskette

Sample display:

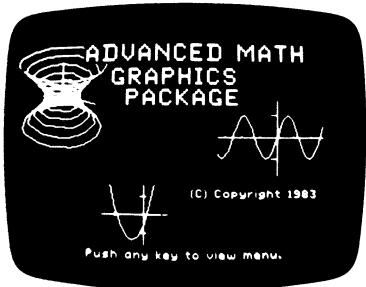

Note: IBM version requires 128K of RAM and a graphics card.

**OHM'S LAW**

(Atari only)

If you are learning electronics, then OHM'S LAW will solve your problems dealing with resistance, current, voltage and power. Of course, if you just sit back and let OHM'S LAW do all the work for you, you will not learn a thing! But it will certainly check your answers for you to guarantee they are correct. It will also solve those problems you claim cannot be solved "because there is not enough information", unless, of course, you are right and there really is not enough information. It will point out to you that the problem can be solved and you are just not trying hard enough.

OHM'S LAW will give you a better insight into what you are trying to learn. It may be used to point out subtleties overlooked in the learning process. The program's ability to perform so many calculations in a very short period of time will allow you to perform many experiments to see more clearly the relationships often overlooked because of the time it takes to make all those time-consuming calculations.

The program can also be used to solve Thevenin's and Norton's theorem problems as well as "T" circuit, bridged "T" circuit and lattice network problems and can aid you when you're designing actual electronic circuits.

OHM'S LAW will not perform magic, nor will it do anything that you yourself cannot do. (Well, maybe it can, but it wasn't planned that way.) But it will do the calculations much, much faster than you can!

It is not necessary to enter any formulas when you use OHM'S LAW. All formulas and special-case relationships are built into the program. There are over 400 of them!

Requires 48K to run. A printer is supported but is not necessary.

Price: \$19.95 Diskette

Sample display:

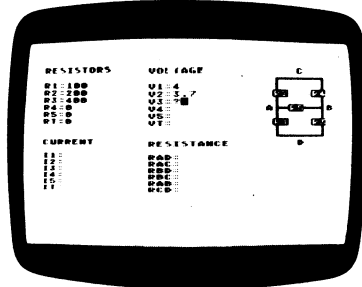

**MOUNT ST. HELENS**

and  
**SOLAR SYSTEM**  
(Atari only)

Here is a combination educational package for ages 8 and up.

MOUNT ST. HELENS is a simulation of the 1980 eruption. The program presents this problem: How do you escape from an exploding volcano? At each point in your escape you are given a series of choices in action. Depending upon your choice, you may or may not survive to your next decision. The problems encountered in the process stress the use of *common sense* and the understanding of *consequences*, and are thought provoking. Includes graphic screens.

SOLAR SYSTEM is a graphics-oriented program which gives information about the planets in the solar system. Attention is captured by showing each planet graphically (including animation), with a list of basic information below the display. Included is a quick-quiz section.

Requires 48K.

Price: \$17.95 Diskette

Sample display:



**ELECTRONIC PROBLEM SOLVER**

(Atari only)

ELECTRONIC PROBLEM SOLVER is a comprehensive package designed to enable you to solve over 100 electronic measurement and design problems even if you have little knowledge of electronics. You do not even have to understand algebra! Additionally, you may extend the functions, range, and accuracy of your test instruments.

Here is a list of menu selections:

- |                           |                         |
|---------------------------|-------------------------|
| Unit Conversions          | Ohm's Law - DC          |
| Resistance of wire gauges | Resistor color code     |
| 5% and 10% resistors      | Combining components    |
| Frequency - duty cycle    | Voltage - duty cycle    |
| Reactance of capacitors   | Reactance of inductors  |
| Impedance                 | Sine wave voltage       |
| Ohm's Law - AC            | Oscilloscope frequency  |
| Oscilloscope voltage      | Instrument compensation |
| Decibels - multiplier     | Voltage divider         |

Choices and values may be entered either from the keyboard or using a joystick. Includes a very carefully prepared 72-page manual designed so that even a beginner can use ELECTRONIC PROBLEM SOLVER.

Suggested audience: Student, hobbyist, experimenter, or technician.

Requirements: 40K RAM, disk drive, joystick (optional), and printer (optional).

Price: \$39.95 Diskette

**BOTANY FRUIT KEY**

(Atari diskette only)

BOTANY FRUIT KEY is an exciting and new approach to identifying common fruits on the Atari computer. You answer the easy to follow questions about the fruit you have just picked off the back yard tree. This program identifies apples, pears, crabapples, maples, elms and many many more ... 125 trees and shrubs in all. You learn how a botanist identifies plants by their anatomy. You learn the common name and the name scientists call them by. And if you get stuck, there's an easy to use glossary. The glossary contains dozens of technical terms, making them fun to learn.

Imagine the world of discovery opened to you when you use this clever computer assisted learning tool. Certainly no classroom should be without it!!! Requires 24K.

Price: \$19.95 Diskette

**GEOMETRY REVIEW**

(Apple and Atari Only)

GEOMETRY REVIEW is intended for use by high school geometry students throughout a traditional course. Using over 100 questions, the program tests ability to define, explain, compute, and identify on the basis of familiarity with definitions, theorems, and postulates. Each of its 7 chapters uses a different type of questioning technique and/or graphic display. The questions within each chapter avoid overlap with any other chapter. In this way the program is usable in the beginning of the course after the first few lessons of any standard textbook have been covered.

The subjects covered are:

1. Points, Lines and Plans
2. Angles, Perpendiculars and Parallels
3. Congruence
4. Quadrilaterals
5. Similarity
6. Right Triangles
7. Circles

Features include sound, graphics, and scoring. Requires 48K and one disk drive.

Price: \$19.95 Diskette

Sample display:

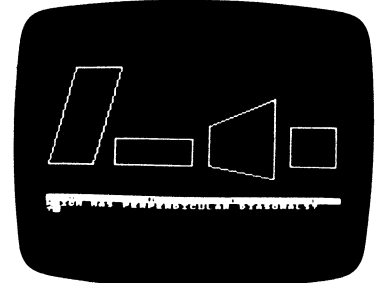

**PROBABILITY THROUGH PROBLEM SOLVING**

(Apple and Atari, diskette only)

This educational package on two diskettes treats probability concepts at a level suitable for grades 7 - 12. Students select from the following menu of subprograms:

- |                     |                         |
|---------------------|-------------------------|
| 1. Introduction     | 7. Playing Cards        |
| 2. Marbles in a Bag | 8. Number Cards         |
| 3. Spinner          | 9. Marble Bag - Complex |
| 4. Parachutist      |                         |
| 5. Dice             | 10. A Game              |
| 6. Coins            | 11. Looking Back        |
|                     | 12. Self Test           |

PTPS makes strong use of an area approach to solving probability problems, giving students a concrete feeling for the concepts involved. The Self Test gives a percentage score, tells the problems missed, the program sections these problems came from, and gives the student an opportunity to return for more work on any program section.

PTPS has been tested extensively with students and found to be easy to use, educationally entertaining and challenging. As you can see (two disks), PTPS is an extensive software package.

Requires disk drive and 32K RAM. Comes on 2 disks.

Price: \$39.95 Diskette

**CLOZE READING COMPREHENSION**

(Pet/Commodore only)

The CLOZE READING COMPREHENSION series is a set of 16 programs, on two disks, which are designed to help second and third graders improve their reading comprehension. Although designed specifically with the New York State DRP Third Grade Examination in mind, this series is generally applicable to second and third grade reading preparation.

Each program presents paragraphs having missing words. Using the context of the paragraph, the student must choose one of several given words to fill in the blank(s). If the answer is incorrect, a clue is given from within the paragraph. The story titles include:

- |                  |                     |
|------------------|---------------------|
| BLIND!           | ANIMALS OF LONG AGO |
| MAKING JELLY     | BLOOD!              |
| ALIGATOR         | OLD TREE            |
| LOST             | PONY EXPRESS        |
| FISH OR MAMMAL   | HOLIDAY PARTY       |
| AROUND THE WORLD | ELEPHANT'S TRUNK    |
| FIRE             | And more!           |

Each program will load in 16K and is 2000/4000 and C-64 compatible.

Price: \$99.95 two Diskettes

**LATIN, FRENCH and SPANISH HANGMAN**

(Availability: see below)

The HANGMAN series offers a new and educational twist on the classic Hangman game. It may be played one of four ways (we will take Spanish as an example):

1. Sentences - English to Spanish
2. Sentences - Spanish to English
3. Vocabulary - English to Spanish
4. Vocabulary - Spanish to English

You are presented with the word or sentence in one language and you have to construct the translation. There are over 400 sentences and more than 1,500 words (depending on disk capacity) to work with. Level: approximately first-year language course.

This is a fun way to get started with a language. The Hangman series has received a rave review (see Review section) in *Softalk* magazine.

Availability: LATIN and FRENCH HANGMAN: Apple only  
SPANISH HANGMAN: TRS-80 and Apple only

Price: \$29.95 Diskette

Sample display:

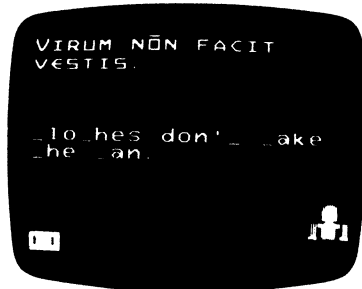

**CHANCELLOR OF THE EXCHEQUER**

(Atari Only)

Test your skills as Great Britain's chief financial officer during the first 100 years of the Industrial Revolution. Eight regions are at your command. As Chancellor you have to decide how to feed the nation's population, develop the natural resources, boost manufacturing, build an integrated transportation system and stimulate trade.

CHANCELLOR OF THE EXCHEQUER is a *simulation* which is both fascinating and educational, and which has received great reviews (see review section).

Requires 48K, and one disk drive.

Price: \$29.95 Diskette

**REVIEW OF HANGMAN**

Reprinted with the permission of *SOFTALK* magazine.

George Earl's hangmen play the traditional game, except that they tell you right out what's to go in the blanks—in another language. *C'est une bagatelle mais je vous l'offre avec amour* is what you're to put in \_\_\_\_\_

How about filling in \_\_\_\_\_ with *Calamitas virtutis occasio est*. Hmmm.

Come back, all you French and Latin students of five or fifty years ago. Well, did you solve those two? Don't feel bad. George Earl's hangmen are terrific for students, but there's a whole league of closet users who just think they're a ton of fun. See, the programs work just like hangman. You guess letters. So, when *jeune fille* is so familiar but just beyond that little twist in memory, put a couple of letters in and you've got it! Such a memory. If you become a closet addict too, don't tell anyone, just enjoy.

The fact is, you can learn or relearn a lot about languages from these packages. There are selections to study the vocabulary and syntax before you play the game. (Closet addicts never look at these first. They take their memory trials straight.) They're well done, and using the computer to learn them really is the spoonful of sugar that makes the medicine of learning go down.

But the games are the neat part. You can choose from among several configurations, or do them one after another; vocabulary (individual words), English to other language, other language to English; sentences (the whole ball game!), English to other language, other language to English. There are also several levels of configuration.

Incredibly, the sentences and words are interesting. There's little of "The pen of my aunt is on the table" (in French, please?) or "The boy is a soldier from Gaul" (Latin Scholars, groan in union). Instead, try these:

- La solitude est a l'esprit ce que la diete est au corps.*
- Es feo, por otro lado, es rico.*
- Non semper facilem habet felicitas aurem.*

In the French and Latin games, the words to be translated and the letters you type in are in big, bold, pleasing hi-res type, complete with appropriate accent marks. All the games keep an on-screen record of your percentage of accuracy for that round. (Closet players: ignore it.)

The wonderful thing is that when you get done with the disk, you've learned a whole lot of another language. Child or adult, it's the same. Combining these very well done programs with a language class would seem an unbeatable move. ■

**INTERNATIONAL VOCABULARY MANAGER**

(Atari only)

IVM was designed for use by the individual student of foreign language. It is well adapted to classroom use as well, and provides a number of tools useful to the teacher.

Each student can create word lists which may be reviewed for study, printed out, and modified. There is no limit to the number of lists. Separate lists can be set up to correspond to lessons, chapters, general topics, etc. The lists are automatically alphabetized.

INTERNATIONAL VOCABULARY MANAGER generates quizzes on the screen, or prints them out on paper. Quizzes can be set up to test for knowledge of either the foreign word or phrase, or its English equivalent. For on-screen quizzes, results for each student are saved for later review by the instructor. During the quiz, the correct answer is displayed after each answer is given. Incorrect items are repeated and are asked first at the next quiz session. Printed quizzes are set up on paper with an answer key, and are ready to be duplicated for classroom use.

Among the valuable utilities provided is a simple word processor, which allows creation of text in any of the languages covered. A sample word list is provided for each language to get you started. IVM is extremely "user friendly". The languages covered are: Dutch, English, French, German, Italian, Latin, Spanish, and Swahili. In addition, Russian capability is provided through a special character set. Lists and quizzes will print out adequately with many printers, but to obtain all accent marks, and to print Russian, a Star, Gemini, or Epson printer is recommended.

Requires 48K of RAM, and one disk drive. A line printer is optional.

Price: \$39.95 Diskette

**LANGUAGE DRILL**

(IBM only)

LANGUAGE DRILL provides a very effective way to rapidly memorize foreign language vocabulary. Using either one of the supplied beginner's lists (French, German, Spanish, Italian, Dutch, and Swahili), or a list entered by the student or teacher, the user is drilled on words selected randomly from the list. After an incorrect (or partially correct) answer is given, the complete correct answer is displayed. Incorrect responses are drilled more frequently, until they have been correctly translated three times in succession.

Words in the drill list can be changed, deleted, or added to. Statistics are kept regarding the number of sessions, number of trials in each session, and the number of right and wrong answers in each session. Words which have been incorrectly identified are retained and drilled again at the next session.

Several students can use the same disk for the same or different languages. Each student's list is kept separately so that the drilling is tailored to that student's needs. Students may also use the same disk for more than one language.

LANGUAGE DRILL can be used for teaching English vocabulary to foreign students since the program will present either the English word (or phrase) or the foreign word (or phrase) as the item to be identified.

LANGUAGE DRILL is intended for use by students at the high school level or above, and for adults learning a language on their own. It is the best and most

**SPELL MASTER II**

(CP/M and IBM only)

SPELL MASTER II is simply the most extensive spelling-education and word-utility software package available. First, SPELL MASTER II contains a spelling vocabulary of over 35,000 words. This spelling list contains words ranging in difficulty from the very simple to the very difficult. Second, SPELL MASTER II can be operated in several modes:

Games:

- Standard Hangman
- Unscramble
- Guess the missing letter(s)

Utilities:

- Scrabble helper
- Spelling checker

Experimental:

- Create your own use for SPELL MASTER II's vocabulary.

The games offer various difficulty levels based on word length, amount of scrambling, and the number of missing letters.

The Scrabble™ helper will take the letters you specify and display the possible words which can be made from those letters. You can even make the search conditional (e.g., there must be an E in the third position and an N in the fifth position).

The spelling checker can work on most ASCII text files created by the popular word processors. It is not an elaborate (or fast) checker, but it does a good job at catching those typos you never seem to be able to see.

The programs comprising SPELL MASTER II are written in BASIC. They are supplied in two versions: expanded and REMarked source listings, and compacted code (for speed). This allows you to make changes if desired, and possibly to compile them. In addition, a utility is provided for adding words to the vocabulary to suit your needs. This vocabulary is not protected and consists of simple ASCII sequential files which you can easily access.

SPELL MASTER II comes on several disks. One disk contains the BASIC programs. The other disk (or two, or three, depending on your machine) contains the vocabulary files.

SPELL MASTER II is fast in the game mode, but moderately slow (depending on the size of the search) in the word-comparison mode. (We have done some "smart" things to optimize the search and comparison procedures. Some of our methods might even be called clever!) However, when in the search mode, SPELL MASTER II can be left unattended to do its job.

Requires at least 48K and two double density disk drives. A printer is supported but is not necessary.

Price: \$39.95 Double Density  
5 1/4-inch Diskettes  
\$44.95 Two 8-inch CP/M Disks

The vocabulary diskette(s)/disk may be purchased separately for \$19.95.

sophisticated foreign language vocabulary drilling program available.

Requires 128K of RAM and one drive.

Price: \$39.95 Diskette

**THE READING PROFESSOR**

(Apple, IBM, and CP/M only)

The best way to describe this package is to print excerpts from a review (J. A. Lewis in *Educational Curriculum*, August, 1984):

"The Reading Professor is a good tutorial for increasing your normal reading rate. There is a difference between reading for comprehension and skimming for highlights. The bulk of the material in the Reading Professor is aimed toward increasing your normal reading rate. The techniques covered are basic and easily transferrable to everyday reading. The reading passages chosen are interesting and enjoyable. . . .

"The Reading Professor consists of two parts—the Lessons and the Exercises. The lessons consist of ten parts which take 15 to 20 minutes each to complete. It is by no means necessary to do all of these at one sitting. . . . The Reading Professor steps you thru the lessons in sequence. If you turn the machine off and start another day, your progress is recorded and you begin where you stopped.

"The lessons can be repeated within the same profile, but are not recorded over your original scores. You must begin a new profile with a new name (or erase the old one) if you wish to see a new lesson profile. The interesting part of the profile for me was the graph. While my reading speed increased steadily as I progressed through the lessons, my comprehension showed an inverted bell curve. As I applied the increased speed techniques, comprehension fell off and then increased as I continued to increase my speed. My overall increase was 30% in speed and 10% in comprehension. This is quite a remarkable increase for such a small investment of time. Even further recommendation comes from the fact that the skills have been retained and I can already use them in daily reading.

"When using the exercises, you can choose from 50 different passages and seven different types of exercises. You have the option to choose eight variables for the exercises which include character size, line width and reading speed, among others. . . . The narrow line width allows me to practice on newspaper column width. The variable which allows you to turn the background off means that you can only see the highlighted words or phrases. This quickly shows if you're reading faster or slower than the rate you have chosen because you cannot look back or ahead.

"Conclusion: For someone who is genuinely interested in increasing their normal reading speed as opposed to speed reading, I feel the Reading Professor can be very useful. The Appendix A has a good passage regarding the rationale of speed reading and I recommend reading it. I will continue to use the exercises and feel I will continue to increase my reading speed and comprehension."

The basic READING PROFESSOR comes with a general interest reading library. Extra libraries (Junior High, Professional, and College) are available.

Price: \$59.95 Diskette/Disk  
Extra libraries: \$15.95 each

**DYNACOMP PRODUCT AVAILABILITY**

DYNACOMP products are also distributed through more than 500 stores in the United States, Canada, Europe, Australia, New Zealand, etc. Why not ask your dealer for DYNACOMP software?

**RAPID READER**

(Apple, Atari, and C-64 only)

This time, instead of our describing the product, we will let a reviewer do it (from *InCider*, September 1983, by Brian Murphy; reprinted with permission). We have included the entire review:

Woody Allen once told a classic joke about speed reading: "I took a speed reading course. I read *War and Peace* in just two hours. It's about Russia."

Of course the point of the joke is that anyone can read quickly, but reading quickly with comprehension is not easy.

If the aesthetics of writing are a secondary consideration and if your studies or work require the absorption of large amounts of information, then speed reading is important. RAPID READER trains your eyes first to take in whole words at a rapid pace, then pairs of words, then phrases, short sentences, and finally long sentences. The trick to fast reading is to learn to take in more than just one word at a time as you read. RAPID READER allows you to approach these skills gradually. You learn to read word by word and then in clusters of words.

A good first step with the RAPID READER program is to find out your reading speed. The Speed Test option found on the main program menu will allow you to select a speed from 50 to 1500 words per minute and a difficulty level from 1 to 4. Once you've made that selection, the program will flash a series of sentences on the video screen. After each sentence appears on the screen, it will reappear with a word missing, which you must supply. The computer will monitor your answers and evaluate your performance.

This is not a real comprehension quiz; there are limits to what a personal computer can do. It cannot judge an essay you write describing the content of the test sentences, but it can determine if you have retained what you've read. At the highest level of difficulty, you are shown two complex sentences. You then fill in a blank for one word (missing from one) of them.

The next step is to build up your speed. If you test out at 400 wpm at the start, key in the Words option from the main menu and practice reading single words at 500 wpm or faster. Once you are comfortable at a new speed, you move to the Word Pairs, Phrases, Short Sentences, and Long Sentence routines. By the time you are comfortable with Long Sentences you should be reading, with comprehension, at the speed you have selected.

To test yourself, select again the Speed Test option from the main menu, and going from levels 1 to 4 of difficulty at your new word speed, see if you really are reading as fast as you'd like. If you need more work, you can always go back to the tutorial options.

One of the many nice things about this software is the option to change the words used to make sentences. You can use this feature to add words from a foreign language—turning the program into a language tutorial as well as a reading program! A Spanish word list is included on the disk.

This is one of the most accessible educational software packages available. The documentation amounts to one page, but even that much is unnecessary. The system is so logical and the program is so self-explanatory that its operation can be mastered in just a few minutes.

As for RAPID READER's adaptability to the classroom, there remains some doubt. This is not a self-checking, record-keeping, or grading program. Without some outside means of evaluating progress, the program can only be used as an aid for more motivated students. For students and professionals who really want to improve their reading speed, the RAPID READER is a most valuable aid.

Apple and Atari versions require 48K. Price: \$29.95

**PRIMER 83**

(Apple only)

As you will see from this description, PRIMER 83 is a unique and effective learning package designed for people with impaired reading skills.

A synopsis of the story behind PRIMER 83 should first be told. Many of you may already know of it from newspaper accounts.

PRIMER 83 was originally written to aid in the rehabilitation of a 30 year old man suffering from "word blindness" (dyslexia). He had a brain tumor which, after removal, resulted in selective memory loss. He worked with many traditional exercises with limited success. With the incentive of sponsorship from Johns Hopkins University, PRIMER 83 was developed to address the needs of this individual and other people with this handicap. PRIMER 83 worked. It also appears to be effective with individuals having other general reading problems.

PRIMER 83 is the culmination of the combined efforts of several people, including the original "student", an expert programmer, a grammaticist, a musician, and several others. It is well thought out and tested.

**REQUIREMENTS**

- The user *does not* need to have prior experience with a computer or have typing skill.
- A moderate-quality cassette recorder is needed: The instructions given in the manual are also recorded on tape.
- A 48K (or more) RAM Apple II or IIe with one disk drive is needed.
- A black-and-white monitor.
- A paddle connected to port #0 (controls display speed).
- A printer is optional. (Used for printing out test statistics and analyses).
- An ECHO II speech synthesizer is optional. (Used for letter and word prompting — nice but not vital.)

Note that a black-and-white monitor is required. Color displays generally do not have the resolution of the black-and-white units. There is no point in *further* handicapping the student with a low-resolution display.

**MODULE DESCRIPTIONS**

PRIMER 83 contains several program modules. The main ones are:

- TALKWRITER — This program is designed to familiarize the user with the keyboard. The keyboard is shown on the screen along with the letter to be typed. If an ECHO II is present, the letter's name will be spoken.
- LETTER FLASH — Letters are flashed on the screen and the user has to press the corresponding key. The duration of the flash may be preset as well as the permitted response time. The results may be saved on disk and analyzed later (see TROUBLE SHOOT, below).
- WORD FLASH — This has the same features as LETTER FLASH. The prompts come from a 600-word vocabulary of common words. These words are organized into 24 groups of 25 words each (e.g., ROAD SIGNS, SIMILAR WORDS, etc.). With ECHO II, each word can also be spoken. New lists may be added easily.
- SENTENCE FLASH — Much the same as WORD FLASH. In this case, 6000 grammatically-correct sentences are displayed (and, optionally, spoken). There are also randomly selected grammatical questions regarding the verb, verb tense, active and passive, subject, subject sex, subject plural and subject singular, object, and punctuation marks.

- MUSIC — Four songs may be played through the Apple's speaker, with the words shown on the screen. The tempo is controlled by the paddle.
- MUSIC EDITOR — You may create your own tunes and words. You may load, save, or play a song, add, change, insert, or delete a note — easily! Notes range over two octaves and can be full to 1/32 notes. Words or syllables can be associated with each note.
- SCI-FI STORY — A nearly infinite variety of short science fiction stories can be created and displayed. The display speed is paddle controlled.
- TROUBLESHOOT — All of the question-and-answer modules have the option to save the results (statistics). The statistics include: number of presentations, per cent errors, average response times, and specific errors. These may be printed if desired. Also, TROUBLE SHOOT will analyze the specific errors to determine the possible perceptual or motor difficulties of: rotation, inversion, similarity, correct key/wrong hand, word truncation, word extrapolation, etc.

**OTHER FEATURES**

- You may choose to use upper- or lower-case letters.
- The character set may be changed (ASCII, Roman, Collasal, and Flow are currently available; you may also design your own font).
- The keys may be re-defined. The keyboard can be put in ABC order instead of QWERTY.
- The 47-page manual is exceptionally clear.

**ADVANTAGES**

- PRIMER 83 is *not* an undirected drill-and-practice program. It can be used to identify weak areas and to strengthen skills in those areas.
- PRIMER 83 is aimed at the reading-impaired audience. The instructions, prompts, etc., are designed to avoid frustrating the students. As many cannot read, the manual is also supplied on cassette, and voice prompts (ECHO II, optional) are available.
- PRIMER 83 allows the teacher to educate more effectively. Less time is spent administering exercises and more time is available for analyzing the results and re-directing the student.
- PRIMER 83 blends in enough of the game reward to make the exercises fun rather than boring.

Price: \$99.95 Diskette

Paddles and ECHO II must be purchased separately.

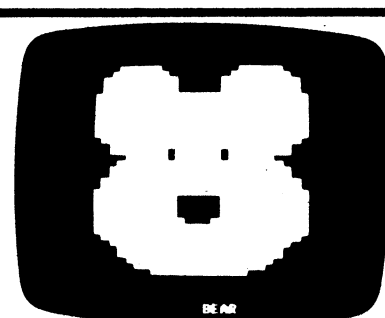

If you have a young child (or grandchild), keep HODGE PODGE in mind. Children love it, and learn, too! See the EDUCATION section for details.



**DIET ANALYZER**

(IBM only)

Anyone who has ever tried to diet knows the problem—count, count, count! Just keeping track of calories is a monumental task. Did you ever stop to wonder about the dozens of other nutrients, like cholesterol, or vitamins, that are usually forgotten?

The DIET ANALYZER makes it easy for you to review and improve your eating habits. You simply enter foods and it automatically shows you 24 nutrients for each food and keeps running totals!

With DIET ANALYZER you can:

- Easily look up nutritional information about foods and adjust that information based on portion sizes.
- Make intelligent menu planning a pleasure. Enter a typical menu and see how it stacks up to what you should be eating. Make a little adjustment here or there until you get it right. Print menus on paper and build a library of nutritionally balanced meals.
- Keep a log of the foods you eat. Periodically compare your average daily intake of 24 nutrients with your targeted goals.

As you insert, adjust, or delete foods in the Work Sheet, all nutrients and totals are instantly and automatically updated.

Foods are entered into the Work Sheet by name. Just type in complete or partial food names and/or category codes (e.g., vegetables), and the computer will display all matching foods from the Food Dictionary.

The Work Sheet accepts a wide range of measuring units for adjusting portion sizes. It allows special units (e.g., a slice of bread, or an egg) as well as the usual weight and volume measures.

Nutritional information may be displayed in physical units (e.g., grams, milligrams, etc.) or as percent of dietary goal.

The Food Dictionary is based on U.S. Dept. of Agriculture tables, and contains many foods typically consumed in American homes. It is easy to add, change, or delete foods. You can add homemade foods by entering their recipes.

**SPECIFICATIONS**

Nutrients listed in Food Dictionary—Calories, Protein, Fat, Saturated fatty acids, Oleic fatty acids (mono-unsaturated fats), Linoleic fatty acids (polyunsaturated fats), Carbohydrates, Fiber, Cholesterol, Sodium, Vitamin A, Vitamin C, Thiamin, Riboflavin, Niacin, Calcium, Iron, Potassium, Phosphorous, Magnesium, and four user-definable nutrients.

The Food Dictionary comes with 500 foods. With 256K of RAM and double-sided drives you can store 1,500 foods.

Individually tailored Goal Profiles of 24 nutrients may be kept for six people.

Diet History provides ample capacity for six simultaneous 7-day diet studies, or an individual 3-month study.

Requires 128K, one single-sided drive (minimum). A printer is supported but is not necessary.

Price: \$49.95 Diskette

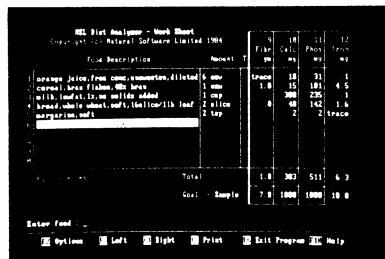
**Excerpt from a review of:  
DIET ANALYZER**

(Reviewed by Michael S. Davidson, *Creative Computing*, March 1985)

"A very significant feature of this program is the Food Dictionary. This database has nutritional information on 500 foods and, depending on your hardware, is expandable to 1,900 foods. You can add, change, or delete items. You can also enter any combination of foods including home recipes, processed foods, and entire meals into the dictionary.

"The program has a fully integrated set of instructions in Help. Using Help will answer any questions about the working of the program and is a highly expanded version of the User's Guide.

"Overall, this superior program is extremely easy to use. The data base is taken from a series of U.S. government sources, and although the accompanying manual does not indicate the credentials of the writers, the program is professionally conceptualized and appears to have been developed by health professionals. It provides the serious diet analyzer with sufficient information to determine his own course of dietary action. I can recommend this program most highly."

**FOR THE BEST PRICES ON EXCELLENT QUALITY DISKETTES, SEE OUR SUPPLIES SECTION. WE DO NOT SELL THE REJECTS, SECONDS, OR REDUCED SPECIFICATION DISKETTES WHICH ARE NOW BEING SOLD AT "AMAZINGLY" LOW PRICES. THEY ARE NOT SO AMAZING IN QUALITY!**

**MYDIET  
NUTRITION & DIET HELPER**

(IBM only)

What should you eat to stay healthy? Are you getting too much salt in your diet? Not enough fiber? Perhaps you would like to lose a few pounds. Now you and your family can use MYDIET to answer these and many more questions about what you eat.

MYDIET creates your personal nutritional profile, based on your height, weight, age, sex, daily activity, and the food you eat. This profile lets you compare what you eat to the Recommended Daily Allowances (RDA) which are published by the US Food and Nutrition Board. MYDIET clearly shows your nutrition excesses and deficiencies and shows a bar chart comparing what you eat to your RDA. In addition, it breaks down your food energy to show the percentage of calories you are getting from fat, protein, and carbohydrate.

You can also create a diet plan to gain or lose weight over a specified period of time. Your diet plan is displayed in a table which tells what your daily calorie intake should be to lose or gain weight.

You can create nutritious meals and store your favorite recipes. Each meal is broken down into its nutritional value and stored in MYDIET's food list.

The foods, your diet plan, the RDA bar charts, and other analysis reports can be listed on your screen or printer, or stored on your disk.

MYDIET can be customized for your particular needs. You can change your RDA values to meet your nutritional needs and you can create a diet plan for your dieting requirements. You can also customize the food list by adding, changing, or deleting foods.

MYDIET is simple to use: all your choices are selected from a list on the screen. Most entries can be made from the numeric keypad. Even the foods are selected from a

menu. Built-in helpful messages tell you what to do if you make a mistake. Pressing one key instantly brings you back to the beginning from anywhere in the program.

You can do the following with MYDIET:

- Track your daily intake of 24 vitamins, minerals, and other nutrients.
- Create and store your favorite recipes, with a nutrition breakdown.
- Print a table showing your nutrition deficiencies and excesses over any period up to 60 days.
- Create a personal diet plan to lose or gain weight over a specified period of time, based on your height, weight, age, sex, and daily activity. Your diet plan can be displayed on your screen or printer, or stored on your disk.
- Customize your RDA values for particular needs. MYDIET automatically adjusts the RDA values for pregnant and nursing mothers.
- Calculate the percentage of RDA for the food you've eaten, or any food or meal in the food list.
- Print a bar chart of the percentage of RDA on your screen or printer, or store it on the disk.
- Print a table showing the percentage of your calories derived from fat, protein, and carbohydrate.
- Store 60-days of diet and nutrition information for up to 22 people (or 120 days for 11 people, etc.).

MYDIET has nutrition information on over 1,000 foods, expandable to over 2,500. It even contains fast foods, such as pizza, McDonald's hamburgers, tacos, etc. All of the food quantities are shown in common units and grams.

Up to 22 people can use a single MYDIET data disk to store their personal diet and nutrition information. (For more users, just make another copy of the MYDIET data disk.)

Price: \$49.95 Two Diskettes

**BEST OF WOK TALK**

(CP/M and IBM only)

Exotic Chinese cooking is made easier than ever with this unique combination of technology and culinary expertise. The editors of *Wok Talk*, popular Chinese culinary newsletter, have assembled over 100 recipes from all regions of China, and organized them for your personal computer on two 5" diskettes or one 8" disk by the COMPUTER CHEF database (included). Easy to use software tells you how to proceed, step by step. You select recipes by ingredients, type of cuisine, or key words and WOK TALK automatically scales ingredient quantities to fit amounts on hand or portions needed. List recipes on your printer as needed; eliminates dripping on your cookbook, too! Expand your on-line recipe file by adding recipes using any word processor. This package includes a 22-page Chinese cooking primer, to help the novice get started, and many challenging recipes for the advanced chef. Here's a new adventure in computer application and eating enjoyment.

Requires 80-column display and 48K of RAM.

Price: \$29.95 Diskette  
\$32.45 Disk

**THE FOOD COMPUTER**

(TRS-80 only)

THE FOOD COMPUTER is an educational tool for analyzing and improving your nutritional intake. Using your age, sex and what you eat (e.g., two servings of ice cream, one serving of potato salad and one shot of rum), THE FOOD COMPUTER calculates the total nutritional content and percentage of Recommended Daily Allowance (%RDA). The program is easy to use and very informative. Great for

**COMPUTER CHEF™**

(CP/M and IBM only)

Now your personal computer becomes a kitchen assistant with COMPUTER CHEF, a versatile home data base that makes page flipping and portion figuring a thing of the past. Tell it the ingredients on hand, and COMPUTER CHEF will quickly suggest recipes using them. Saves you money by finding recipes for this week's supermarket bargains. When you need more servings, or have less of an ingredient than is called for, COMPUTER CHEF automatically scales the recipe to fit your individual needs. Prints recipes on your printer, so you never again need to worry about dripping on your cookbook! Contains over 70 kitchen-tested recipes from salad to desert, plus make even more use of all these capabilities by entering your own recipes too. By Marietta & Jim Gilogy, Pamela Chavez, and Michele Schumow.

Reviewed in *Infoworld* (October 11, 1982), *Portable Companion* (September 1983), and *Pro-Files* (Volume 1, Issue 1). Written by Software Toolworks

Requires 80-column display and 48K. CP/M version 2.0 or higher is required (e.g. for Kaypro, Osborne, etc.)

Price: \$29.95 Diskette  
\$32.45 Disk

dieters and parents concerned with the nutrition of their children. Let your teenager run THE FOOD COMPUTER to see the value of what he/she is eating. They may not listen to you, but maybe they will believe THE FOOD COMPUTER.

A printer is supported, but not necessary. Requires 32K for cassette or 48K for diskette. Price: \$15.95 Cassette  
\$19.95 Diskette



**CLASS RECORD**  
(IBM and CP/M only)

CLASS RECORD comes in two versions. The IBM version can handle classes of up to 180 students; the CP/M version, up to 36 students. Apart from this, both have the same features.

CLASS RECORD can meet the requirements of teachers at every level, from elementary through university. Written by a university professor, it is the first program to have the features and options which college classes require.

Basic Features:

- Speed. CLASS RECORD was written in Turbo PASCAL and is compiled for quick execution. It sorts 36 records in about 2 seconds, 180 in about 6 seconds.
- Ease of use. CLASS RECORD is completely menu-driven and can be run by persons with no previous computer experience. The manual gives a complete step-by-step explanation of every aspect.
- Automatically sorts and displays the names of students together with optional ID numbers and Credit/No Credit (or Pass/Fail) status.
- Corrections are easily made through questions at the bottom of the screen. The results are immediately displayed. Further corrections or later corrections can be made through menu items.
- Can record up to 10 assignments and 8 quizzes.
- Automatically converts marks (e.g., scales).
- Choice of grading systems. You can use either straight letter grades or letter with + and -. You can set the numerical range for each grade. You can also change the symbols if desired (e.g., E, G, S, P, and U in place of A, B, C, D, and F). This marking system can be saved on disk under the teacher's initials and called up for other classes.
- Print out records for:
  - Any assignment or quiz.
  - Any individual student.
  - Complete record: assignments, quizzes, score, mark, rank.
  - Summary record: final score, mark, rank.
  - Summary record: sorted by ID numbers in place of names.
  - Graph and statistics.
- Options for determining overall mark:
  - Lowest assignment does not count: This is an option chosen by many teachers who give many assignments. If this option is chosen, then all assignments have equal weight, but quizzes, exams, or papers may be assigned any weight. The program goes through each student's record, drops the lowest assignment, and then computes the mark with the weighting factors assigned.
  - All assignments count. You may have all assignments count equally or you may assign weights for each.
- Print out all records for each student. CLASS RECORD can print out a separate page for each student listing the mark on every assignment or quiz, the overall score, mark, rank. There is a place for further written comments. This can be used at the end of the course. It can also be used any time during the course. After mid-term exams, for example, it is possible to give each student a summary of the record to date and indicate the mark and class rank. This is a convenient way of letting students know of failing grades or missing assignments.
- All bookkeeping, scaling, etc., is done automatically.
- Any scores or grades determined by the computer can be changed. The teacher ultimately assigns the marks, not the computer.

- Posting marks. Teachers often want to post marks so that students can know their grades quickly. Yet they also wish to preserve secrecy. The program sorts records by ID numbers. If the ID number contains 9 digits, the final one is truncated. There is a legal reason for this. Many schools use Social Security numbers as ID numbers. It is against the law to post Social Security numbers.

- New Subject. CLASS RECORD will make a copy of the basic information on names, ID numbers, Pass/Fail status, but not marks. This is designed for teachers who wish to keep separate records of the same class for each subject (e.g., elementary school).

- New Marking Period. This is designed for teachers who need a new record for each report card period.

- Password Option. If the records are kept on a school computer, then each person can have a password to ensure privacy and security from tampering.

As you can see, CLASS RECORD has a fairly powerful set of features. Also, it is very easy and convenient to use.

Requires two drives and 64K RAM (CP/M), 128K RAM (IBM). CLASS RECORD does not require BASIC or any other programming language.

Price: \$49.95 Diskette

**CATALOG CARD AND LABEL WRITER**  
(IBM, Apple, C-64, TRS-80 Model III/4 only)

CATALOG CARD & LABEL WRITER reduces the time spent on this meticulous yet tedious chore. You input the information when prompted, just once, and your micro becomes a specialized word processor that automatically formats and prints catalog cards and book pockets and spine labels, as many copies as you need. CATALOG CARD & LABEL WRITER provides individual flexibility in card format while not sacrificing ease of entering information. You can do hanging indentations, long subject entries, and, if you have more information than will fit on one card, it will do a second card. Author or title main entry is provided for. The style followed is based on *Commonsense Cataloging* by Piercy.

Even if you get the bulk of your cards with your books, CATALOG CARD & LABEL WRITER will still pay its own way for those additional subject cards, non-book materials, and books you receive as gifts. It works well with audio-visual materials and software. A variety of catalog card formats can be used.

Aside from a standard 80-column printer and a single disk drive, CATALOG CARD & LABEL WRITER requires continuous-form cards and labels, sources for which are listed in the documentation. A lower-case adapter (add \$30) is required for the Apple II+. Some IBM compatibles require BASIC in the 40-column mode.

Price: \$159.95 Diskette

Recommended by *Booklist* magazine.

Reviewer's comments (*Small Computers in Libraries* magazine):

"This procedure can produce a substantial savings in staff time by removing the necessity to either type or duplicate multiple card sets or to type added entries onto duplicated or purchased card sets. There is also a savings and convenience over the purchase of card sets from off-site locations. Many librarians would see an attractive benefit in being able to easily customize their cataloging and not having to adapt their own cataloging style to that of a card-production company or consortium... documentation that is clearly understandable and sufficient in quantity and detail... suitable for librarians who are first-time microcomputer users."

**MICROTEACH COURSEWARE PACKAGE**  
(Atari only)

MICROTEACH is a courseware development package designed to help the teacher prepare and administer computerized mini-courses. To use this package you (and the student) do not need to know how to program; rather, you follow simple instructions.

The MICROTEACH system comes in three separate modules which are on three disks.

TEACHER'S AIDE DEVELOPMENT MODULE

This module helps the teacher build a courseware disk containing the desired lessons. You are supplied simple graphics facilities and screen-editing functions to facilitate lesson construction. In other words, you may build and edit screens which have both graphics and text.

Each screen is numbered and the presentation (to the student) is programmed. For example, there are several types of questions available and, depending on the student's response, the lesson is directed from the 'test' screen to an 'answer' screen. This is ideal for programmed learning or review exercises.

These question formats are available:

- Multiple choice
- True/False
- Yes/No
- Fill-in-the-blank
- Matching
- Programmed instruction

Page presentation time may be controlled, student progress may be reviewed, etc. This module makes it very easy to create a very substantial lesson.

**EARN-IT/PLAY-IT**  
(Apple only)

EARN-IT/PLAY-IT is an automated "contingency management" program for classroom use; access to computer games is contingent upon the student's behavior.

Each use of EARN-IT/PLAY-IT with a student is called a session. Generally a session is one school day. The teacher may identify up to nine objectives for each student during a session (e.g., completes homework, passes quiz, zero rate of misbehavior). At the end of a session, the teacher records whether or not the student has achieved each objective. If a specified proportion (say 65%) of the objectives is achieved, the student is rewarded with game credits. Game credits give the student an opportunity to play one of the games contained on the EARN-IT/PLAY-IT disk. The student may choose to save the game credit or use it immediately (if the teacher permits). EARN-IT/PLAY-IT will keep track of each student's game-credit balance. To maintain the student's motivational level, new games become available at certain milestones. There are six different games on the DYNACOMP disk. At game time, the student can select any available game for which he/she qualifies. Naturally, the more interesting games cost more game credits.

Requires 48K and one disk drive.

Price: \$29.95 Diskette

Note: EARN-IT/PLAY-IT has been very successfully used in a therapeutic program for rehabilitation (see *COMPUTERIZED REINFORCEMENT OF BEHAVIOR: A HEAD INJURY CASE*, Fifth International Symposium, *Models and Techniques of Cognitive Rehabilitation*, Indianapolis, Indiana, March 30 - April 3, 1985. Maxwell, Dubin, and Thompson).

STUDENT PAK MODULE

This module is used to run a courseware disk created by the development module. It interprets the information on the courseware disk and presents it as determined by the teacher.

COURSEWARE MODULE

This is the lesson module created by the teacher. It is run using the STUDENT PAK. Note that a minimum configuration is one DEVELOPMENT module and one STUDENT PAK module and these modules are sold SEPARATELY. Teachers usually purchase just one DEVELOPMENT module and a half-dozen or more STUDENT PAKs, depending on their needs. Requires two disk drives.

DEVELOPMENT MODULE  
Price: \$39.95 Diskette

STUDENT PAK  
Price: \$19.95 Diskette

ACCOUNTING COURSEWARE  
Price: \$19.95 Diskette

NOTE: The MICROTEACH package was originally published and advertised by COMPUMAX. DYNACOMP has acquired the publishing rights and is offering these modules at a substantially reduced price.

**MASTER DRILL**  
(TRS-80, Apple, C-64, CP/M, and IBM only)

MASTER DRILL is a utility specifically designed for the educational environment. With MASTER DRILL you can quickly and easily set up multiple choice drills on any subject you desire. All you do as the drill creator is respond to the prompts. The program will ask you for the question and its corresponding answer. Later, when that question is presented to the student, between two and nine (your choice) multiple choice answers will be presented, one of which is correct. The incorrect answers are drawn at random from the answers to the other questions. For those who have written multiple choice tests, you know how much time this feature can save.

In addition, if your questions have a common beginning phrase (e.g., "WHAT IS THE CAPITAL OF"), you may pre-set this so that you need only type the remainder of the question when prompted. In this way files can be quickly built (and added to), and very nice drills created. Included on the disk is a sample drill called CAPITALS.

Price: \$18.95 Diskette

Sample display:





## EDUCATION - TEACHING AIDS

### COMMODORE 64 TUTORIALS

(Commodore 64 only)

The two-volume COMMODORE TUTORIAL set teaches the fundamentals of the Commodore 64. It explains the topics in an easy-to-understand manner using audio-visual aids. To assist comprehension, reviews and short quizzes are included.

Volume I contains an introduction to the Commodore keyboard and Commodore BASIC. It is designed for the first-time user.

Volume II is more advanced. It explores the process of sound synthesis and the features of the Commodore 64 that are built in for this purpose. To enhance understanding of the subject, a special controller is included which enables the user to experiment with various sounds.

Volume II also explains the nature and function of sprite and character graphics. Different graphics techniques are discussed in simple and clear terms. A sprite editor is provided to assist the user in creating sprites.

Available only on diskette.

Price: Volume I \$24.95 (Diskette)  
Volume II \$24.95 (Diskette)

### WORD PROBLEMS

(IBM only)

WORD PROBLEMS helps to improve problem-solving skills. It presents a series of interesting stories. Each story is made up of a sequence of challenging word problems for a child to solve.

WORD PROBLEMS gains the child's interest by using an animated character called "Tex the Tutor". Tex guides the child one step at a time through the word problems providing response and encouragement. This motivates the child by showing that problem solving can be fun. It also gives needed interaction which cannot be obtained from conventional instructional materials.

The word problems presented are the result of extensive research about specific skills necessary when solving addition and subtraction word problems.

#### Features

- Controlled vocabulary (1.5-2.0 reading level)
- Interesting children's stories
- Reinforcement of important mathematical skills
- Instruction in regrouping skills needed to solve addition and subtraction problems
- Emphasis on labeling skills to encourage critical thinking
- Positive interaction with the child's responses

WORD PROBLEMS takes full advantage of color graphics to entertain and teach proper arithmetic skills. This includes the graphic presentation of regrouping (i.e., borrow and carry).

WORD PROBLEMS is a solid educational aid to instructors. It generates detailed statistics which evaluate the child's performance. These statistics can help identify specific problem areas in which the child is experiencing difficulty (e.g., solving addition with carry). The program is simple enough in function for home use and is accompanied by an extensive MANAGEMENT SYSTEM. The MANAGEMENT SYSTEM allows a parent or instructor to give specific, individual assignments to a child and monitor progress. It is especially suited to the classroom environment allowing an instructor to control a class of up to 40 students.

Requires 128K, and a color graphics card. BASIC is not needed.

Price: \$29.95 Diskette

## EDUCATION - TEACHING AIDS

### CAT (COMPUTER-AIDED-TEACHING)

(TRS-80 only)

The CAT (Computer-Aided Teaching) package consists of two programs, CATGEN and CAT. CATGEN is used by the teacher to create lesson, test and lesson plan files. CAT is used by the student to run the lessons and tests created by the teacher.

A lesson created by CATGEN consists of a screen of mixed text and graphics, with an optional practice question mode. In creating the lesson the keyboard directional controls are used to place the cursor and write mixed text and graphics.

The teacher may also enter up to 50 multiple choice questions, with 5 possible answer selections for each question. Automatic correction and scoring is provided by CAT during the administration of the test.

The lesson plan file creation procedure provides the teacher with a method of automatically administering a specific sequence of lessons and tests to the student. The lesson plan consists of a chain of lesson file and test file names, which will automatically be run by CAT when the lesson plan is entered.

Editing options are provided. Most commands are menu-selected, and the operator is prompted for most entries.

The CAT portion of the package provides the operational environment for student use of the files created by CATGEN. The student is prompted to enter his/her name, the date, and the name of the assignment. CAT automatically types the selected assignment and proceeds to present the lesson or test to the student. CAT provides correction and scoring for practice questions and tests, and presents the results and correct answers to the student. The results may be optionally sent to the printer. Error checking and trapping is provided to prevent crashing the program through nonsense input.

If a lesson plan is loaded, CAT will automatically load and run the lessons and tests contained in the plan. Otherwise, the student must enter an assignment name for each lesson and test.

COMPUTER AIDED TEACHING is flexible enough to be used for every subject and grade level. It can even be used in business and industry for training. Includes a detailed manual. Requires 48K. Printer optional.

Price: \$39.95 Diskette

Bob had 7 little cars.  
His mother gave him 2 more  
little cars.  
\*\* How many cars does he have in  
all?

$\begin{array}{r} 7 \\ + 2 \\ \hline 9 \end{array}$	Pick 1, 2, or 3. _____ (1) mother _____ (2) cars _____ (3) Bob
---	--

## EDUCATION - TEACHING AIDS

### GRADECALC

(Commodore 64 only)

GRADECALC helps teachers in two ways. It has the ability to list, average, and cumulate students' grades (letter or numeric) and it can generate valuable reports, thus adapting to all your grading needs. It can also help you spot attendance problems immediately as GRADECALC not only maintains daily attendance records, but also includes cumulative totals and problem reports based on excessive absences. GRADECALC can be adapted to your specific recordkeeping needs with little effort. It accommodates 18 classes per disk with 8 grade categories. GRADECALC supports a printer, which is required if you wish to use the Histogram Plot feature.

Price: \$34.95 Diskette

Review results (*Chime Newsletter*, College of Education, Oklahoma State University):

Performance	A
Ease of Use	A
Error Handling	A
Documentation	A+
Appropriateness	A
Educational Value	A
Overall Evaluation	A

Review Comments (*Commander* magazine, March 1984):

"In my opinion, GRADECALC would be an asset to any teacher. For those fortunate enough to have a computer in the classroom, GRADECALC would be a real timesaver and end some of the paperwork drudgery. GRADECALC would be worthwhile even if the data has to be generated at home or duplicated from a conventional gradebook."

### THE LIBRARIAN

(Apple, and TRS-80 III/4 only)

This simple, fast, database program lets you economically store, retrieve, and cross-reference bibliographic abstracts of indexable items. It is specially designed to store and retrieve items by categories, subject matter, and key words. THE LIBRARIAN also stores abstracts of up to 252 characters.

You may do any of the following with THE LIBRARIAN:

- Enter and edit items.
- Search for specific categories or key words in any field.
- List all items in your file.
- List all retrieval categories with their associated items.
- List all major headings with categories and items grouped within.
- Alphabetize anything except the abstracts.
- Set up individual disks to handle different types of items.

Requires 48K. A printer is supported.

Price: \$44.95 Diskette

### FEELING BETTER

(Apple II only)

FEELING BETTER is an education program designed to help children reduce their feelings of anger, upset, depression, anxiety, and guilt. It begins with a presentation about the nature of feelings and emotions, so that the child will be able to label and identify them when they occur. It then presents a simple but powerful A > B > C method for the analysis of emotionally disturbing events, and shows

## EDUCATION - SELF

### UNDERSTAND YOURSELF

(Available for all computers except Atari)

UNDERSTANDYOURSELF is a series of tests designed to help you to determine the real you. Based on the book *Test Yourself*, by Dr. Harry Gunn, the several programs which compose this package are designed to disclose your character. The computer does all the scoring. Each test is simple to take and requires nothing more than a press of a key to answer any question. A full set of directions is built into each test and messages appear at the bottom of the screen whenever you are required to do something. Self-testing could never be easier!

UNDERSTANDING YOURSELF contains these tests:

- The Assertive Test
- The Conscience Test
- The Manipulation Test
- The Personal Equation Test
- A Test of Marital Adjustment
- Measurement of Personal Adjustment
- Individual Scale of Values
- Preferred Activities Test
- A Test of Sexual Attitudes

Each of us has many facets to his or her personality, and many are not sure where they stand in their attitudes relative to the norm. UNDERSTAND YOURSELF helps you achieve this understanding in a non-threatening manner.

Requires at least 48K.

Price: \$19.95 Diskette



### MEET YOURSELF (As You Really Are)

(Apple only)

MEET YOURSELF is a guide that takes you on an extensive tour of the less well charted regions of your own psyche. It will help you discover new and unsuspected aspects of your personality. As your individual character portrait unfolds, your problems will be discussed and set against the background of some of the wider issues of life. These may bear upon your case or throw light on questions of general interest and significance beyond your immediate personal concern.

The format used is a mixture of questions and observations. The package consists of over 200 blocks of routines, not all of which are used in the analysis of any one individual. Each routine acts in conjunction with a personal text file that you will set up in the second disk drive. From the information that is stored in the text file and the answers to the questions, you will be guided to further questions or observations (not always kind!) about your personality.

MEET YOURSELF requires 48K of RAM, and two disk drives. It comes on five diskettes.

Price: \$39.95 Five Diskettes

the child how to feel less upset in response to those events. Interest is maintained by animations, noises, bells, etc.

The FEELING BETTER package contains one diskette, a manual, a package of FEELING BETTER Self Analysis Forms, and a package of emotional knowledge tests for pre- and post- testing.

Price: \$39.95 Diskette

**APPLESOFT TUTORIAL**

(Apple 48K Only)

As with DYNACOMP's ATARI UTILITIES and DIVERSI-DOS diskettes, here is another package which DYNACOMP is distributing as a public service. Quite frankly, DYNACOMP believes that the more you know about programming the more you will appreciate DYNACOMP's products and the more at ease you will be with your computer.

APPLESOFT TUTORIAL is an educational disk (which is nearly full!) of menu-driven lessons on how to use Applesoft BASIC. It is designed with the beginning computerist in mind, and is an excellent way for a novice to get started. Just put the diskette in the drive, turn on your computer, and start learning how to program.

Price: \$9.95 Diskette

Cannot be used towards quantity (3 or more, 5 or more) discounts.

**CP/M-MS DOS TEACHING TESTING AND TRAINING PROGRAM**

(CP/M and IBM only)

The most important first step in acquiring computer literacy is to learn how to use your computer's operating system. For CP/M and MS DOS machines, this is no mean feat!

The 3T package was designed to be a school in itself, simulating the classroom environment. There are text lessons, multiple-choice questions, and coaching. Test scores are used to direct the student backwards or forwards in the lessons.

Many prominent computer trade journals have evaluated 3T and found it to be one of the most successful simulations of a school format.

3T was designed and programmed by Software Academy and is used in its computer school. If you are a beginner to CP/M or MS DOS, become our student!

Price: \$69.95

Be sure to tell us whether you have an IBM (MS-DOS) or which CP/M computer you have.

**SOUND DEVELOPMENT SYSTEM**

(Commodore 64 only)

The SOUND DEVELOPMENT SYSTEM (SDS) makes it possible for you to have sound effects and music within your own BASIC or machine-language programs. SDS exploits almost every aspect of the C64/128's sound capabilities.

SDS has a variety of applications. Use it as a programming tool or as a learning aid (for those wishing to simply experiment with sound and music). Create your own instruments, or use some of the example instruments provided. Any sound you can imagine can be created with ease and speed. Develop multi-instrument songs or simple sound effects. SDS even provides an option to view the sound data (for the more advanced users).

The fully detailed manual, along with examples, takes you through each step, clearly and simply. You do not need to know music to use SDS, though the effects you can produce do improve with your experience level.

Includes a 50-page manual. A printer is supported but is not necessary.

Price: \$29.95 Diskette

**PC CHORD PRIMER™**

(IBM only)

The PC CHORD PRIMER™ is a package of software programs for the IBM Personal Computer that are designed to provide interactive assistance to the serious guitarist. The program capabilities range from a built-in library of over 600 chords to a set of automated lessons on music theory for guitar.

The program is divided into two major components. One consists of educational programs that include lessons on general chord structure and chord progression patterns. The other serves as a computerized reference manual or handbook. It provides a chord encyclopedia that automatically searches for chords by name or musical key, programs to assist music composition and transposition, and a guitar tuner.

This computer-assisted guitar tutorial has several advantages over standard reference books.

1. Many of the programs provide audio support through the PC's music synthesizer. This allows the user to hear as well as see the relationships between notes and chords.

2. The program automatically searches its chord data base to find chord positions. This reduces the time normally spent flipping through reference manuals.

3. By letting the computer perform chord transpositions the user can avoid referring to complicated chord tables and transposition formulae.

4. The program utilizes printer support so that hard copy reference material can be generated instantly if needed.

5. Screen graphics are fully used.

Requires an IBM with DOS 1.1, 64K memory, the IBM graphics board, color or monochrome monitor, and one disk drive. A printer is supported but not necessary.

Price: \$49.95 Diskette

**MUSIC TUTOR**

(Commodore 64 only)

MUSIC TUTOR is a set of 21 programs designed for teaching music in grades 3 through 10. The programs can be used with students who know very little to students with a substantial knowledge of music. The programs are "user friendly" and simple to operate. Complete program descriptions are given along with recommended applications, scores, options, and worksheets. The programs tutor, review, and quiz students visually and aurally on new and old aspects of music. Students are instructed from a beginning level and are taken to the level of composing a simple, single-line melody. Many of the programs are game-based. All of the programs are designed and used by a practicing music teacher. The many available options make these programs an excellent supplement to any music program.

Teachers are permitted (encouraged) to make copies of the many worksheets provided.

Programs: DEMO, MUSIC TUTOR, NOTE VALUES, REST VALUES, MUSIC BOX, NOTE NAMES, NOTE NAME W/ACC, RHYTHM MATCH, RHYTHM BOX, MAJOR KEY SIG, MINOR KEY SIG, KEYBOARD AND INTERVALS, CHORD STRUCTURE, CHORD LISTENING, SCALES, MODE MATCH, PITCH MATCH, SOUND MAKER, COMPOSER, GUITAR CHORD TESTER, PITCH CONVERSION.

Includes 16-page description and 16 worksheets.

Price: \$39.95 Diskette

**MUSIC BY MATRIX**

(Commodore 64 only)

Music has changed more in the last 50 years than in all the time prior. Methods of teaching music have hardly changed at all in the last 300 years. MUSIC BY MATRIX is designed to bring the music student up to date.

The single most important concept a music student must understand is interval theory. There are a number of chords and scales that the student must learn. This is not a small task; it becomes much larger when the student tries to transpose these chords and scales into all 12 keys. The MUSIC BY MATRIX system is designed as an audio-visual aid to help the student understand chords and scales in terms of the intervals involved. This one factor can take years off the time that it takes to teach the basic components of music theory.

In summary, the matrix system is designed to make it easier for the music student to learn basic music theory. The matrix system is not designed to teach standard music notation, nor to replace it. To get the most out of the program, the user should know how to read and write music, at least at a basic level. The student who knows how to read simple songs is ready for this program.

MUSIC BY MATRIX is also written for music hobbyists who have no desire to learn how to read and write music. It includes two experimental music generators that offer an easy way to access the sound and music capabilities of the Commodore. By simply typing a couple of numbers, you can listen to a large variety of computer-generated music. For the musician who composes, the matrix is shown to be an excellent format for writing modern music.

MUSIC BY MATRIX also explains the seven modes. Understanding how these modes are formed and used is very important to improvisation, harmony, and melody. A sound generator is included that allows the creation of music based on traditional harmonies. It is a very simple way to use the computer to compose.

Finally, MUSIC BY MATRIX lets the user experiment with mathematical tonalities. There is a short explanation of how our Western music system differs from Eastern music. The matrix is used to generate a wide range of experimental tonalities; it is also very simple to use.

Price: \$29.95 Diskette

**MUSIC BY MATRIX, DISK #2**

(Commodore 64 only)

Disk #2 picks up where Disk #1 ends, with five programs, the first being TRIADS.

TRIADS explains the diminished triad and the diminished chord, and shows their relationship to the simple cycles. Most musicians have heard of the Cycle of Fifths, and some of them know that it is the inverse of the Cycle of Fourths. Very few musicians know about the remaining simple cycles and how they are used. The augmented and suspended fourth triads are also detailed in TRIADS, and tests are included for all 3 triads to help you gauge your progress.

The next program on Disk #2 fully explains the matrix with a series of examples. The simple cycles are covered in detail, and the matrices illustrate how they are related. Interval theory is introduced in a manner that is easy to understand and a table of intervals is included that will be a useful addition to any musician's library. A music generator is provided to allow you to experiment with the tonalities of the simple cycles.

MELODY BY MATRIX (the third program) introduces the concept of using the matrix to work with existing melodies. The melody line to *Mary Had a Little Lamb* is placed on the Y axis of a series of matrices, and the X axes vary. Selection of the music generator offers many

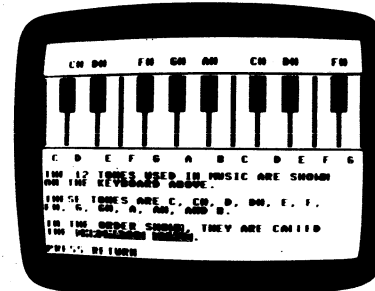

**THE SOUND LIBRARY**

(Apple only)

THE SOUND LIBRARY is designed to aid programmers in using sounds. It comes with 39 prepared sounds and explains how to produce your own effects.

THE SOUND LIBRARY is divided into two basic parts. The first consists of the library of sounds and their parameters (in BASIC). The other serves as the sound generator (in machine language) for the library.

All of the sound routines are menu-selected and are easy to understand.

With THE SOUND LIBRARY you can generate whole, half, quarter, or eighth notes as well as unique sounds. You may freely copy the routines from the library to add to your own sound programs!

Price: \$19.95 Diskette

options. The melody and/or the X axis of the 30 and 45 degree diagonals may be listened to in various combinations. Some of the tonalities are really astounding.

For the composer, the possibilities are myriad. The matrices contain an infinite amount of related harmonies, any of which might be the basis for a piece. Some sound good enough to use exactly as they are; others must be altered to the composer's taste.

The fourth program, MUSIC BY NUMBER, offers a unique experimental music generator. Songs can be written simply by typing numbers for the notes. (Anyone can easily learn to enter songs from sheet music, and the person who doesn't read music might end up learning to as a bonus.) The melody is then placed on the Y axis of the matrix; sound selection offers any combination of the melody and the 30 or 45 degree diagonals. Imagine harmonizing your songs with the diagonals of a matrix!

The last program is a tutorial on the pentatonic scales. Beginning with a short review of some of the materials covered on both disks, the section goes on to discuss briefly some of the methods by which many "standards" have been written.

You can save the songs that you (or the computer) write to disk. A number of songs are provided to get you started. The notes in the melody and the diagonals can be printed (on the screen) for analysis. Compositions can be played over and over again on a group of matrices; this is ideal for serial harmonization and composition.

In summary, MUSIC BY MATRIX, Disk #2, is a valuable addition to any music student's library, and for any computer hobbyist who enjoys music.

Price: \$29.95 Diskette

**FAST FOURIER TRANSFORM TUTORIAL**

(Apple, Kaypro, and IBM only)

FAST FOURIER TRANSFORM TUTORIAL is a menu driven, graphics oriented education program designed for both class room use and self-instruction. The program itself presumes no knowledge of the mathematics associated with Fourier Transforms. Rather, it permits hands-on experience showing (in high resolution) what the spectra of various waveforms look like. For example, you may examine the spectra of mixed sinusoidal, rectangular, saw tooth, triangular and random inputs under an infinite variety of conditions. You may even input your own signal. Further, you may examine the spectra of several window functions and digital transmission formats.

The resulting spectra may be plotted as well as listed. It should be stressed that FFT is an educational program, which is highly tutorial in character. It does not have the data storage, retrieval and editing features of DYNACOMP's HARMONIC ANALYZER. However, if you want to get a feeling for Fourier Transforms, or already have some knowledge and want to learn more, this is a good program to use.

Requires 48K. Includes a manual which describes in some detail the mathematics of the FFT. Included on the DYNACOMP disk are an Applesoft and a compiled object program.

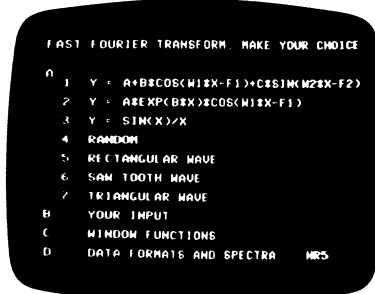
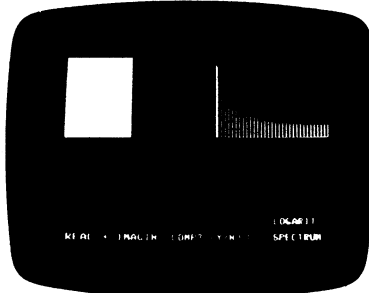

NOTE: IBM version requires color graphics card; Kaypro version requires Kaypro 2-84 or 4-84 (graphics versions). Apple version requires 48K.

Price: \$39.95 Diskette

**Z-TRANSFORM TUTORIAL**

(Apple only)

This is the second selection in DYNACOMP's complex plane analysis educational series, the first being FAST FOURIER TRANSFORM TUTORIAL. In Z-TRANSFORM TUTORIAL poles and zeroes and their relation to the Z-transform are described theoretically (in the manual). The resulting filter response function is discussed with respect to rational polynomials and "tapped delay lines". The tapped delay line representation is shown to be amenable to a "difference equation" implementation of a digital filter.

The software is keyed to the manual. You may enter either the pole/zero representation, or the rational polynomial filter function coefficients for up to 30 poles and zeroes. If you give the poles and zeroes, the program calculates the transfer function. If you give the transfer function, the program will give you the poles and zeroes. Also, you are provided with high resolution plots of the amplitude response and impulse and step function responses. Several examples are given.

If you are interested in learning about the Z-transform, the "unit circle", poles and zeroes, and so on, try Z-TRANSFORM TUTORIAL.

Price: \$24.95 Diskette

window them. The variety of high resolution graphical examples is infinite, making DFDT an excellent tool for either home or classroom instruction. Requires 48K.

Price: \$24.95 Diskette

**S-PLANE TUTORIAL (SPT)**

(Apple only)

This is the fourth member in DYNACOMP's complex plane filter analysis series. The SPT manual discusses the development of analog filters through the use of pole/zero representations. Subjects covered include the narrow and broad band approximations, the unit circle, the Butterworth, Chebyshev and linear phase solutions.

The second part of the package, the software, allows the determination of complex poles and zeroes and graphical examination of the frequency responses associated with the material in the manual. You may analyze the responses due to the poles/zeroes which you provide, or determine the poles/zeroes and responses for various order Butterworth, Chebyshev and Thompson filters. The variety is infinite, and emphasis is placed on graphical displays.

Price: \$24.95 Diskette

**TWO-PORT ANALYSIS TUTORIAL**

(Apple only)

Here it is — number seven in DYNACOMP's electrical engineering tutorial series. This analysis package allows you to learn about and examine the transfer characteristics of "black boxes" having two ports (four terminals). For example, a transistor may be considered a four-terminal device if the base is used for two of the terminals (e.g., common base configuration). The device description used is based on Y-parameters.

The manual has two sections. The first deals with the theory behind Y-parameter descriptions and response stability. The second part deals with computer examples, in particular the design of a transistor amplifier having several RLC components.

As with the other packages in this series, the software is graphics-oriented. The equivalent circuit is pictorially displayed on the screen, as well as the  $G_L$  circle corresponding to the stability limit. Also superimposed are the  $B_L$  circles.

This package is ideal for the student or professional who is studying linear systems. Price: \$24.95 Diskette

**INVERSE FAST FOURIER TRANSFORM TUTORIAL**

(Apple only)

INVERSE FAST FOURIER TRANSFORM TUTORIAL (IFFT) is an educational program which was designed to be used by teachers and students to familiarize themselves with the IFFT and its effect on transforms. It is also useful to engineers and scientists who wish to learn about the IFFT, its operation, and the general ability to reconstruct signals (time functions) from their discrete Fourier transforms.

The documentation is broken into two parts. The first part deals with the theory of the Fourier transform pair in general, the discrete Fourier transform (DFT), the Fast Fourier transform (FFT), and frequency domain filtering. Many graphical examples are included throughout.

One of the unique features of IFFT is that it also contains a routine which shows the distortion of serial (e.g., NRZ) transmissions by a telephone line. You specify the length of the line and the baud rate, and the program graphically displays the distorted bit pattern. Also shown are the "eye patterns" used by communications engineers to evaluate such transmission lines.

The second part relates to operating the program. To run the program, just follow the prompts. You can specify various standard signals (or your own) and the sampling interval. Up to 128 points may be specified (or loaded

**BILINEAR TRANSFORM TUTORIAL**

(Apple only)

Here is number five in the advanced electrical engineering tutorial series. This one deals with the bilinear transform and how it can be used to derive digital filters from analog RLC filters. The package layout is similar to the others; tutorial documentation with examples, and graphics oriented software. Requires 48K.

Price: \$24.95 Diskette

**POWER AMPLIFIER DESIGN TUTORIAL**

(Apple only)

Meet number six in DYNACOMP's electrical engineering tutorial series. This installment deals with vacuum tube RF power amplifiers. As with the other numbers of the series, the theory is covered in detail in the documentation, with emphasis on graphical analysis. The software graphically deals with the amplifier design factors, plots the path of operation and anode current, and calculates more than nine other characteristics. Included is a complete sample exercise for designing a Class B amplifier. A nice educational purchase!

Requires 48K.

Price: \$19.95 Diskette

**PHASE-LOCKED LOOP TUTORIAL**

(Apple only)

Here is number eight in our electrical engineering tutorial series. The theory part of the package includes discussion of synchronized multivibrators, VCO's the NE555, MC1648, phase detectors, AFC, hold-in range, etc. The program part allows you to experiment with building a phase-locked loop from phase-detector, low-pass filter, and VCO blocks. You may simulate TV synchronization (a picture of Kirchoff may be "played with") and examine hold-in and lock-in both visually and analytically. Of particular interest are the effects caused by the use of various filters and filter functions.

PHASE-LOCKED LOOP TUTORIAL may be used in a college-level electrical engineering course as a teaching aide, or as a refresher.

Requires 48K and one disk drive.

Price: \$49.95 Diskette

from disk). Or you can specify the harmonics (up to 64) directly. You may also specify the filter or use a pole/zero description. Real and imaginary coefficients may be used.

You do not need to know how to program to operate IFFT. However, you should be familiar with FFT (see our FFT Tutorial) in general. Requires 48K

Price: \$29.95 Diskette

**COLLECTIONS**

The entire set of eleven electrical engineering tutorials may be purchased for a combined price of \$199.95. This includes eleven manuals and eleven diskettes in a plastic storage box. Sorry, collections do not count toward the DYNACOMP 10% - 20% volume discount.

**FREQUENCY DOMAIN FILTERING TUTORIAL**

(Apple only)

FREQUENCY DOMAIN FILTERING TUTORIAL (FDFT) is DYNACOMP's ninth installment in its growing engineering tutorial series. This particular addition is an extension of FAST FOURIER TRANSFORM TUTORIAL to two dimensions.

As usual, the package consists of two parts; the manual and the program diskette. The manual describes the theory behind the two-dimensional discrete Fourier Transform along with pictorial illustrations (3-D representations are included). You may then visually examine the results of transforming and filtering various two-dimensional patterns (including bars, sine waves, good old Kirchoff, etc.). The results are displayed as either a spectrum density plot (picture) or a 3-D representation. You may choose from a menu of ideal filters, or input your own. You may choose images from the menu, or create your own.

Because the calculations involved are so time consuming, you are provided two versions of the calculation program: a compiled version (default) and a source (Applesoft) version for examination. Also, instructions are given regarding how to generate your own images. You may also load images from other programs in the DYNACOMP engineering tutorial collection.

Requirements: 48K RAM, one disk drive, and some initial familiarity with Fourier Transforms. FDFT is an ideal tool for advanced image students, photographic science students, or scientists interested in reviewing or gaining new knowledge. Prior experience with FAST FOURIER TRANSFORM TUTORIAL is recommended, but not absolutely necessary.

Price: \$29.95 Diskette

Sample display:

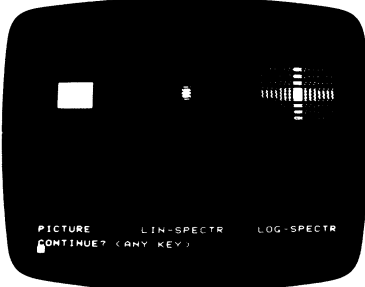
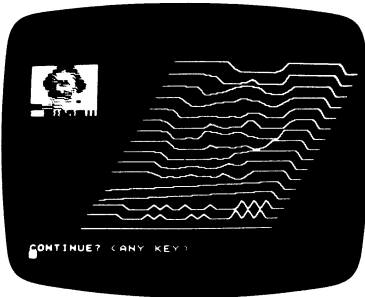

**CORRELATION**

(Apple only)

CORRELATION is another member of the DYNACOMP engineering tutorial series. As usual, the package consists of a manual coordinated with software. The manual presents the theory and describes how to use the software, and the software shows visually the principles covered in the manual.

The subject areas included are: autocorrelation, power and energy spectra, cross-correlation, cross-spectral density, convolutions, and matched filters. The computer examples include correlation (e.g., burst correlation, a means for radar ranging) and two-dimensional template matching. Many variations are offered in the examples (e.g., adding various levels of noise to two-dimensional images, random binary signals, random analog signals, different waveforms/templates/pictures). High-resolution graphics are employed wherever possible to make the presentations clear.

Price: \$19.95 Diskette

Sample display:

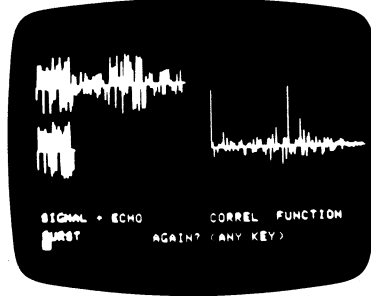
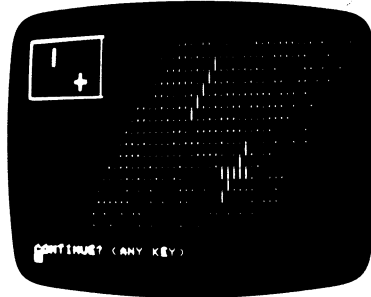

**ORIGIN OF THE DYNACOMP ENGINEERING TUTORIAL SERIES**

DYNACOMP's series of engineering tutorials was developed to meet the classroom needs of electrical engineering courses in a technical college. These packages have been found to be very effective in that setting, and offer an excellent means for individual instruction. DYNACOMP has been chosen as the exclusive publisher for this material because of its extensive involvement in the sciences and its wide distribution. More topics will be added as they become available.

**PORTVIEW 2020**

(IBM only)

PORTVIEW 2020 is a record keeper, investment analyzer, and tax planner all in one. PORTVIEW 2020 will easily compute your return on investment (ROI) for any investment and will, optionally, adjust all figures for inflation.

Imagine how much more effective your investing could be if you could quickly compare past, present, or future investments based on after-tax ROI. As an example, suppose you are trying to decide between two \$10,000 investments.

A. Oil Partnership: You get an immediate 100% tax loss, then you expect income of \$3,600, \$3,600, \$2,700, \$1,800, and \$900 in each of the next five years.

B. Technology Stock: You expect your investment here to be worth \$30,000 in four years.

Using PORTVIEW 2020, you could quickly find that the ROI would be 23.48% for the Oil Partnership and 19.97% for the Technology Stock, after tax and inflation. These and other figures available from PORTVIEW 2020 have been charted below:

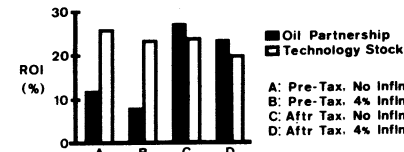

Additional PORTVIEW 2020 features:

- Handles any investment: stocks, bonds, mutual funds, real estate, commodities, partnerships, options, etc.
- Creates these and other reports:

Complete investment history for a list of holdings, including purchases, sales, cash dividends, reinvested dividends, assessments, and splits

Complete price history for a list of holdings

Net Worth on any date for a list of holdings

Performance of a list of holdings between two dates, showing amounts invested and earned, and ROI

- Easy to use: Simple interactive commands, help screen, and full error handling.
- Well organized 64-page manual with many examples
- Handles 1,000 transactions plus certificate numbers and other comments with 128K total memory

Here's what PORTVIEW 2020 users have to say:

*I have used PORTVIEW for over a year now and I wanted to let you know how pleased I am with it. . . I have certainly earned many times the purchase price in increased returns.*

*Richard T., Ft. Collins, Colorado*

*I certainly believe that all users of [PORTVIEW 2020] will . . . achieve sound investment analysis to support their objectives, and have fun along the way!*

*Harry P., Marysville, Washington*

Requires 128K of RAM and DOS 2.0 or above. A printer is supported.

Price: \$79.95 Diskette

A demonstration diskette and manual are available for \$24.95.

**PERSONAL COMPUTER AUTOMATIC INVESTMENT MANAGEMENT**

(CP/M and IBM only)

PERSONAL COMPUTER - AUTOMATIC INVESTMENT MANAGEMENT (PC-AIM) will assist you in accumulating a fortune, automatically. It helps beginners and experienced investors alike make money by doing little more than following a few simple and unemotional rules about buying and selling stocks. PC-AIM is unlike any other investment approach and is designed to operate in any kind of a market (bull or bear) with anysize investment. It does not require that you possess stock market expertise or mathematical skills, and it manages one stock or many, as well as handling your cash.

PC-AIM is based on a proven concept developed by investment expert Robert Lichello. A manual calculation system is described in his best-selling book, "How to Make \$1,000,000 Automatically" (SIGNET books). PC-AIM enables the investor to easily create and maintain data files containing company/corporation name, number of shares, cash, and interest earned. It calculates stock value, portfolio value, buy/sell advice, and market orders, as well as return on investment (ROI). In addition, it maintains current and historical records of all transactions for evaluation of investment performance.

PC-AIM uses screen menus and all data is input with the assistance of screen displays and prompts. User entries are edited extensively and all entry errors are trapped. The system always maintains backup master files.

PC-AIM provides the following capabilities/functions:

- Inputting/Maintaining Stock and Cash Information
- Adjusting Stock Price(s)
- Calculating Buy/Sell Advice and Market Orders
- Maintaining a SAFE (Braking Factor) Dollar Amount
- Maintaining Historical Records of All Transactions
- Computing Return on Investment

The outputs of PC-AIM are eight display and/or printer reports. These are:

1. Stock Review
2. Portfolio Review
3. Buy/Sell Advice
4. Portfolio ROI
5. Stock History
6. Portfolio History
7. Stock History ROI
8. Portfolio History ROI

PC-AIM is designed to be user friendly and does not appear to be complex as far as the user interface is concerned. It offers investors a viable alternative to relying on the advice of others.

The PC-AIM documentation describes fully the software operation as well as all data items, files, and file recovery.

Requirements:

CP/M versions: 64K memory, two floppy-disk drives (minimum of 160K each), or one floppy and one hard-disk drive.

IBM and IBM-compatible versions: 128K memory, two floppy-disk drives (minimum of 360K each), or one floppy and one hard-disk drive.

Both versions require an 80-column printer (dot matrix or daisy wheel will both work).

Price: \$149.95 Diskette(s)



**COMPUSEC PORTFOLIO MANAGER**  
(Apple only)

Except for modem downloading of stock data, the COMPUSEC PORTFOLIO MANAGER does everything that the DOW JONES Market Manager does, and more (but for a much lower price!).

Here are some of the COMPUSEC advantages over DOW JONES:

- Ranks each stock in any portfolio, showing which stocks should be reduced or eliminated, and which should be increased.
- Calculates for any stock, the compound growth rate between the earnings-per-share for an earlier time period and the earnings-per-share for a later time period.
- Calculates the payback period (years to earn back the market price), based on the calculated growth rate or your own estimated growth rate.
- Shows daily volume.
- Automatically records date and time when quotes were fetched.
- Shows unrealized gains and losses with subtotals: short term gain, short term loss, net short term, long term gain, long term loss, net long term, as well as combined total net gain or loss.
- Shows analogous helpful breakdown for realized capital gains and losses.
- Shows number of securities held as well as total number of shares held.
- Shows average cost per share for total holdings of each security, as well as average cost per share for each separate holding.
- Permits entering exact costs (including cents). Also permits entry of securities costing less than \$1.00.
- Requires only one disk for both program and portfolios, though additional portfolios may be recorded on additional disks.
- Requires only one disk drive.
- Permits viewing or printing of all reports, and hence does not require a printer.
- Provides for automatic adjustment of cash figure when:
  - 1) purchases and sales of securities are made
  - 2) additions to, and withdrawals from, cash are made
  - 3) a mistake is made and a reversal of a sale has to be made

- Permits giving each portfolio a full name (such as John Q. Investor).
- Subtotals net capital gains and losses for each security, even when different lots are sold on different dates. This greatly simplifies tax return preparation.

Quite frankly, the review (12/83, *SOFTALK Magazine*) of the DOW JONES package served as good guidance on how to make a far superior product!

Includes a 100-page manual. A printer is supported, but is not required.

Price: \$79.95 Diskette

Sample printouts:

EXHIBIT I  
PRYMOCH FOR JOHN Q. INVESTOR STATUS AS OF 10/20/83 19:03 EASTERN

SYMBOL	NO.	YRS	CHG	JP	NO	IF	MO	PRICE	10	MO	CHG	ESTD	CHG	ESTD
DO	4.83	2.50	JN	3.64	5.37	52.25	9.73	-8.11	0.15	NOF	6.44			
IBM	1.14	2.50	JN	7.29	10.71	129.75	11.69	0.89	0.16	SI	7.10			
NEA	2.74	2.50	JN	5.63	6.24	29.75	4.77	0.25	0.20	3.27	5.44			

EXHIBIT II  
QUOTES FOR JOHN Q. INVESTOR STATUS AS OF 10/20/83 19:03 EASTERN

SYMBOL	NO.	YRS	CHG	JP	NO	IF	MO	PRICE	10	MO	CHG	ESTD	CHG	ESTD
SEC	BID/CL	ASK/OPEN	HIGH	LOW	LAST	VOL								
DO	4.83	3.75	5M	1.30	6.81	26.13	18.81	0.97	0.20	3.20	5.40			
IBM	11.75	11.75	11.75	11.75	11.75	11.75	11.75	11.75	11.75	11.75	11.75			
NEA	31.00	31.00	31.00	31.00	31.00	31.00	31.00	31.00	31.00	31.00	31.00			

EXHIBIT III  
HOLDINGS FOR JOHN Q. INVESTOR STATUS AS OF 10/20/83 19:03 EASTERN

SYMBOL	NO.	YRS	CHG	JP	NO	IF	MO	PRICE	10	MO	CHG	ESTD	CHG	ESTD
DO	4.83	2.50	JN	3.64	5.37	52.25	9.73	-8.11	0.15	NOF	6.44			
IBM	1.14	2.50	JN	7.29	10.71	129.75	11.69	0.89	0.16	SI	7.10			
NEA	2.74	2.50	JN	5.63	6.24	29.75	4.77	0.25	0.20	3.27	5.44			

EXHIBIT IV  
REALIZED CASH FOR JOHN Q. INVESTOR STATUS AS OF 10/20/83 19:03 EASTERN

SYMBOL	NO.	YRS	CHG	JP	NO	IF	MO	PRICE	10	MO	CHG	ESTD	CHG	ESTD
DO	4.83	2.50	JN	3.64	5.37	52.25	9.73	-8.11	0.15	NOF	6.44			
IBM	1.14	2.50	JN	7.29	10.71	129.75	11.69	0.89	0.16	SI	7.10			
NEA	2.74	2.50	JN	5.63	6.24	29.75	4.77	0.25	0.20	3.27	5.44			

EXHIBIT V  
NET SHORT TERM

SYMBOL	NO.	YRS	CHG	JP	NO	IF	MO	PRICE	10	MO	CHG	ESTD	CHG	ESTD
DO	4.83	2.50	JN	3.64	5.37	52.25	9.73	-8.11	0.15	NOF	6.44			
IBM	1.14	2.50	JN	7.29	10.71	129.75	11.69	0.89	0.16	SI	7.10			
NEA	2.74	2.50	JN	5.63	6.24	29.75	4.77	0.25	0.20	3.27	5.44			

You may evaluate up to 17 funds per database (there is no limit to the number of databases). Share prices for each fund are conveniently entered on a weekly basis. Dividends and share distributions are entered as they occur and FUNDWATCH automatically adjusts the database to reveal actual resulting performance.

FUNDWATCH comes with a 38-page manual explaining its uses in detail and which clarifies concepts for beginning investors.

Requires 128K of RAM, DOS 2.0 (or higher), and a graphics card. A graphics printer is necessary if you want printed plots.

Price: \$29.95 Diskette

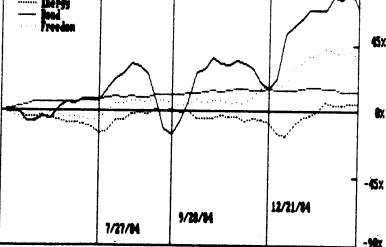

**FUNDWATCH**  
(IBM only)

FUNDWATCH is an easy-to-use, menu-driven tool created to simplify evaluation and comparison of various common investments including mutual funds, stocks, bonds, and many commodities such as energy and precious metals. FUNDWATCH is designed to allow home investors to seriously evaluate such investments inexpensively and quickly without requiring a modem or a costly data network subscription. Although especially suited for the fast-growing market of mutual funds, FUNDWATCH can be used to evaluate virtually any type of capital growth or income oriented instrument, including market averages such as the Dow Jones Industrial Average.

FUNDWATCH conveniently:

- Calculates yields.
- Predicts annual yields.
- Evaluates trends (using variable moving averages; you choose the trend period).
- Creates comparative graphs depicting normalized performances.
- Provides direct comparisons with interest-earning investments.
- Maintains basic portfolio information.

**STOCK MASTER/STOCK PLOT**  
(Apple diskette only)

STOCK MASTER and STOCK PLOT are companion programs designed to help the investor record fiscal data on companies of interest, record stock transactions, and track price action on these same companies. With these programs you may:

- Maintain records for up to 30 stocks.
- Store 10 years of fiscal data for each stock (including revenue, earnings per share, return on equity, quarterly earnings per share, and quarterly dividends per share) and historical price data limited only by diskette storage space.
- Maintain up to 8 portfolio files which are composed of any combination and any number of shares of the stocks you are tracking.
- Record up to 20 buy/sell transactions for each of the stocks you are tracking.
- Enter transactions in a capital gains file and list or print your capital gains by year and by short or long term.
- Enter prices of any or all of the stocks at whatever frequency you desire. In addition to writing files to maintain historical records of those prices, STOCK MASTER will maintain files of the Dow Jones Industrial Index, the Standard and Poor 500 Index, and the NASDAQ Index at the same frequency.

Price: \$59.95

Sample display:

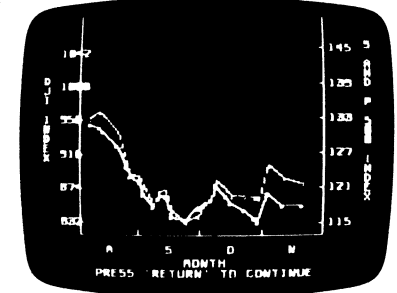

**PORTFOLIO MANAGEMENT**  
(Apple, TRS-80, CP/M, and IBM diskette only)

The PORTFOLIO MANAGEMENT package was written by a stock broker to help manage portfolios for individual customers. With this program, data files can be easily created and kept up to date. A variety of reports, attractively and professionally laid out, can be generated for clients. The user may define his/her own investment categories. PORTFOLIO MANAGEMENT is a top-quality professional tool which will not only provide you with conveniences but will also serve to enhance your appearance as an efficient and up-to-date advisor to your clients. Comes complete with a 30-page manual.

The CP/M version is aimed at the individual user. It contains all of the basic features of the Apple version, but it is tailored to the individual investor. In addition, detailed file sorting and plotting capabilities have been added. The CP/M version includes a 67-page manual (50 pages of instructions and examples and 17 pages of program listings) and requires 48K.

The Apple version requires two drives.

Price: \$69.95

Sample display (Apple):



**MICROCOMPUTER STOCK PROGRAM (MSP)**  
(available for all computers)

The MICROCOMPUTER STOCK PROGRAM (MSP) is designed to help you analyze stock prices. It provides timing signals for stock purchases and sales. Buy and sell indicators are generated by means of a unique autoregressive price trend analysis. MSP requires only weekly high, low, and close prices and the volume of shares to aid your investment decisions. It has several features:

- generate buy/sell signals for the last 8 weeks
- print a volume/price/moving average chart on any 80- or 132-column printer.
- complete data maintenance facilities, including on-screen viewing and easy editing for adding, changing or deleting data.
- simple adjustment for stock splits and dividends
- list price/volume data to printer
- completely menu driven and easy to use.

MSP is provided with documentation which includes instructions for operating MSP and tips on how to employ MSP effectively.

System requirements: cassette, with 16K RAM (minimum) or one diskette, with 32K RAM (minimum). Printer optional.

Price: \$55.95 Cassette  
\$59.95 Diskette  
\$62.45 Disk

**STOCK MARKET BARGAINS**

(IBM only)

After more than 40 years of successful application by many individual investors and mutual funds, the intrinsic value theories of Benjamin Graham have been programmed for use on the IBM (and compatible) personal computers.

STOCK MARKET BARGAINS provides two tests for categorizing, evaluating, and storing statistics on stocks considered under-valued ... and ripe for purchase by the shrewd investor.

**Test I — The Graham Approach**

The first test is based on theories Benjamin Graham set forth in his landmark books *Security Analysis* and *The Intelligent Investor*. In this test, a stock's investment value is "graded" by its Quick Liquidation Value.

This value indicates what would be distributed to each share of stock should a company pay all its short- and long-term debts out of current assets and distribute the remaining current assets to shareholders. If this projected distribution amount substantially exceeds the stock's present market value, the stock is considered to be selling at a bargain price.

For example, a stock with a market price of \$6 per share and Quick Liquidation Value of \$10 per share is, more often than not, a bargain-priced investment. Using STOCK MARKET BARGAINS, you can identify these stocks.

**Test II — Pre-set Values You Can Change as Needed**

While the Graham approach exemplified in Test I can lead to some excellent bargains, it is not always possible to find a large number of stocks satisfying these criteria. Because of this, a second, less stringent approach to identifying undervalued stocks is provided in Test II of STOCK MARKET BARGAINS.

Test II evaluates stocks according to five parameters—all programmed with pre-set values. In contrast to Test I however, Test II selection parameters may be altered to your specifications.

**Test II Parameters:**

- Price/Earnings Ratio
- Number of Institutional Investors
- Ratio of Current Assets to Current Liabilities
- Change in Earnings per Share
- Current Earnings per Share

Four of these five parameters are designed to ferret out those companies exhibiting healthy cash positions and favorable price levels regardless of the product or service a company provides. The fifth parameter, number of institutional investors, is a measure of obscurity designed to find companies that haven't been extensively scrutinized by professional analysts.

These companies may not have attracted the attention of the large institutional investor either because the companies are too new or too small. In either case, such stocks are fertile hunting ground for undiscovered bargains.

STOCK MARKET BARGAINS is menu-driven and allows you to:

- Display and/or print out all stocks satisfying Test I and Test II
- Display complete data on file about any given stock
- Add new stocks for analysis at any time
- Update the data for stocks already in your computer's data files

You are given guidelines that will enable you to enter the necessary data from the Stock Guide quickly and efficiently.

Price: \$69.95 Diskette

Requires 128K.

**PORTFOLIO STATUS**

(IBM only)

PORTFOLIO STATUS provides a convenient means for generating timely analyses of security portfolios for the individual investor or the investment advisor. The user enters the name of each security, the ticker symbol (if desired), the number of shares, the purchase date, and the cost. To generate an analysis of the portfolio, the user enters the price of each security and the program proceeds to compute the current market value, profit or loss, percent profit, and days since purchase for each security, and then to compute totals.

The program is completely menu driven and, in so far as possible, checks are provided to catch obvious input errors such as mistyping a date (e.g., 06/08/1084 for 06/08/1984). If a new portfolio is to be entered, the first question asked is for its name. When the user supplies a name, he/she is asked to enter the data on as many securities as are in the portfolio. When that is completed, a menu is presented asking whether there are to be additions, deletions, or changes, or whether records are to be examined, or the status of the portfolio is to be computed. Additional menus are provided at each step so no knowledge of computers is required to run the program.

The results are presented in alphabetical order and may be displayed in 80-column format on the screen or in 132-column format on a printer. Requires 64K.

Price: \$29.95 Diskette

**CASH FLOW PROJECTION**

(Apple only)

CASH FLOW PROJECTION is designed to provide a quick method for estimating future cash flow (before income tax) which may be generated by producing oil and gas leases for their remaining economic life.

Future production of the primary phase is calculated using the exponential-decline method. Up to three different exponential-decline segments may be used to calculate each lease projection, in order to approximate hyperbolic-type declines. It is much easier to break a hyperbolic-decline curve into three exponential segments than to determine the correct components of the hyperbolic curve. A yearly exponential-decline rate, beginning monthly production rate, and an ending monthly production rate are entered for each segment. If more than one decline segment is entered, the ending monthly rate signals a cutoff point for production rate calculations at that decline rate. The second decline segment is then used and finally the third segment is used to calculate projected oil and gas production. Whether one, two, or three segments are used, the last segment will be used for calculations until a negative cash flow calculation has been performed. The secondary phase is calculated from a gas-oil ratio.

The program generates a printed report giving the input assumptions, gross oil and gas production, net oil and gas production, oil and gas prices (which may be escalated each year to a stipulated cutoff price), net oil and gas revenue, net operating expense (which may be escalated each year to a stipulated cutoff amount), net severance taxes, net windfall profits tax, net salvage value, net before income tax yearly and cumulative cash flow, net before income tax yearly and cumulative discounted cash flow, and net before income tax cumulative discounted cash flow for four alternate discount rates. All five discount rates are selected by the user.

Individual projections may be totaled and a composite projection report may be printed out giving the combined results.

Requires 48K.

Price: \$99.95 Diskette

**MICROCOMPUTER CHART PROGRAM**

(TRS-80, CP/M, and IBM only)

MICROCOMPUTER CHART PROGRAM (MCP) is all the software you need to create charts to follow the stock market. MCP uses either daily or weekly stock high, low and close prices and trading volume. The data files it creates are completely compatible with those created by MICROCOMPUTER STOCK PROGRAM (MSP). MCP has features which make it unique among the investment software available today. These features include:

- the same data editing, maintenance, printing and price adjustments as MSP.
- stock price charts with:
  - price range, range and close, or close prices transformed by:
    - moving average
    - centered moving average
    - exponential smoothing
  - inverse of any price transform as a bar chart
  - constant-width envelope for either centered moving average or exponential smoothing.
- volume bar chart.
- smoothed volume line.
- up to 3 stock price or volume charts overlaid on a chart.
- smoothed velocity (price change) line.
- on balance volume, using percent price change.
- support for printers from 31 to 223 columns per line.

MCP can use the system you have to the fullest. Additional memory and storage allow larger price/volume files to be created and used. A wider printer allows more complex charts to be generated.

Requires 32K and printer (at least 31 columns wide).

Price: \$59.95 Cassette  
\$63.95 Diskette

Sample display:

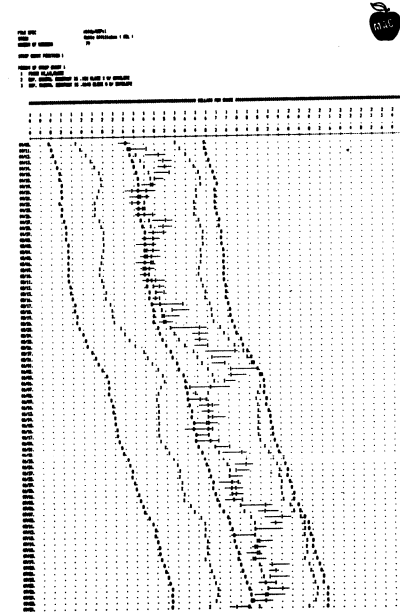

**INVESTING ADVISOR**

(TRS-80 and IBM only)

THE INVESTING ADVISOR is a tool that will help the investor make unemotional decisions about the buying and selling of his investments. It incorporates a means of timing the purchase and sale of investments based on a price-trend analysis and on buy/sell rules. It includes the ability to track both long- and short-term trends, so that the investor can pick the best strategy for his needs. Up to 64 long-term and 64 short-term investments can be tracked at the same time. The investor can initialize his data base, add or delete investments, calculate the action to take and adjust the data base for splits of the investment. Data is entered daily for short-term investments and is entered weekly for long-term investments. The data entered is the closing price for the investment, available from the newspaper. It is in the form of the price as it appears in the paper.

The objective of the long-term investment strategy is to go over a year, if possible, without selling. The selling rules provide a reasonable compromise between the desire to go long-term and the need to protect profits or to prevent substantial losses, if the investment turns down significantly. The objective of the short-term investment strategy is to maximize capital gains without regard to the tax consequences of selling. The selling rules provide a compromise between giving the investment room to maneuver as it moves up and the need to protect profits or to prevent substantial losses, if the investment turns down.

The program has been written to be as structured as possible. The logical levels of the program have been indented so that the user can understand the flow of the programs, if he desires. Requires 48K.

Price: \$39.95 diskette

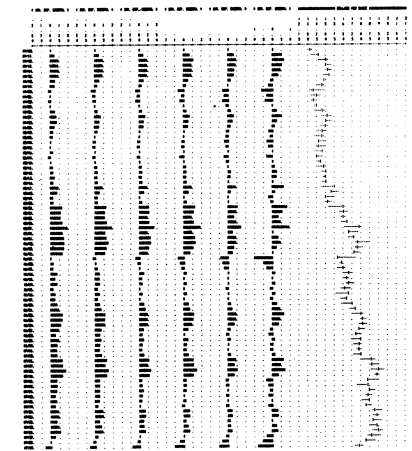

**MSP and MCP COLLECTION**

(TRS-80, CP/M, and IBM only)

MICROCOMPUTER STOCK PROGRAM and MICROCOMPUTER CHART PROGRAM are available as a collection for \$93.95 (two cassettes), \$99.95 (two diskettes) or \$104.95 (two disks). Add \$6.00 for double-density diskettes. This collection can not be applied towards quantity discounts.

**THE CALCUGRAM STOCK OPTIONS SYSTEM**  
(TRS-80, and IBM only)

The CALCUGRAM STOCK OPTIONS SYSTEM will give you the analytic power you need for full control of risk and profit in your option investments. You will be guided in the selection of the right options and the best combination. Also, the exclusive daily follow-up program lets you know when to close out at best advantage.

The pricing model used by the CSOS is based on Modern Portfolio Theory and is amazingly accurate. Since actual market prices of options often deviate considerably from the model values, spreads or hedges containing long positions in undervalued options,

and/or short positions in overvalued puts and calls, can be surprisingly safe and profitable. Combinations with over 95% chance of profit are not uncommon.

The first program in the software package computes normal (theoretical) values, differences from actual prices, and implied volatilities for the options on a stock. This is what you need for picking candidates for your spreads.

The main program, Options Hedging, lets you examine the prospects of spreads and combinations. You can determine the best ratios among the options, and find the probability as well as the magnitude of future profit. Gain curves are presented both in graphic and tabular form, and for any selected future date. Round-trip commission and margin requirements are calculated, and net profit tables are printed.

Because option prices fluctuate around the normal values, the profit in any hedge position varies from day to day. A third program is included to let the investor follow the progress on a daily basis. It takes only a minute to input the latest stock and option prices and get a printout showing the profit if the position is closed that day.

The manual consists of two parts: first, a valuable introduction to option terms and general advice; second, a demonstration of the use of the program with typical examples.

The CALCUGRAM STOCK OPTION SYSTEM has been in use for several years with remarkable results. Here are the comments of one user:

*I can't tell you how much I appreciate your Calcugram option program. It is not only educational but I am actually making more money now in option hedging than I have ever made in any kind of investment even when I used a broker.*

*For the first time in my life I feel comfortable with combination hedges.*

Requirements: 32K (TRS-80) or 64K (IBM), two disk drives, an 80-column printer, a color graphics board (IBM); (optional).

Price: \$149.95 TRS-80  
\$169.95 IBM PC  
\$ 19.95 Manual only

**EXCERPTS from a review of BUYSEL**

(by Brian Greiner, Software Now!, April 1985)

"The manual consists of thirty-five pages... It is well written, and explains every aspect of the program fairly completely. One section I particularly appreciated, was a 'walk-through' of all the various features using sample data files to show how the program worked. The manual explains in detail the parameters used by each trading method, and gives some detailed background information for each method. There is also a brief bibliography of books the program's author found useful.

In use, Buyisel is rather a lot of fun... I used the supplied data files to analyze a sample stock and commodity with no problem... Buyisel is useful not only for picking the best investment strategy for a particular stock, but also useful for weeding out the dogs... The program seems reasonably crash-proof and easy to use.

Overall, Buyisel seems like a useful tool for people interested in the stock market. It offers the user a number of different trading methods to choose from, and is fairly simple to use.

**COMPUTRONICS MARKET PAC**  
(TRS-80, Apple, IBM, and CP/M only)

THE MARKET PAC is a selected set of 37 separate programs designed to help both financial professionals and private investors in the analysis of positions and prospective positions in various securities. The programs range from the most-often-used investment calculations and formulas to sophisticated programs like a complete portfolio bookkeeping system that keeps track of your investment records.

Just select the function you want from THE MARKET PAC's Main Menu and the computer will guide you step-by-step through the operation. For a more in-depth look at each function, a user's manual is provided that gives complete full-page descriptions of each calculation and function in THE MARKET PAC.

With THE MARKET PAC your microcomputer will be able to perform all of these calculations:

- Annuity Analysis
- Computation of Alpha and Beta Values for Security
- Option Valuation and Hedge Ratio using the Black-Scholes Method
- Bond Valuation — Yield to Maturity & Other Values
- Future Net Worth and Present Value of Projected Investment Schedule
- Compound Interest Computations
- Estimate of Future Earnings Per Share
- Date Computations (Number of Days Between Any Two Dates)
- Option Writing Computation
- Portfolio Listings with Various Profit/Loss Analyses
- Portfolio Selection by Sharpe's Method
- Rate of Return — Variable Inflow
- Valuation of a Share of Stock
- Value of a Warrant
- Investor's Rate of Return on a Convertible Bond
- Dilution Analysis
- Arbitrage Computations
- Future Price Estimation with Inflation
- Seasonal Quantity Indices
- Financial Ratios
- Merger Analysis
- Value of a Right
- Depreciation vs Cash Flow
- Time Needed for Money to Double, Triple, etc.
- Time Series Analysis — Linear Trend
- Time Series Analysis — Moving Average Trend
- Brokerage Commissions
- Margin Account Computations
- Advanced Option Strategies
- Money Market Computations
- Forecasting Cash Flows
- Leverage Analysis

Computronics suggested list price: \$99.95.

Dynacomp's Discount Price: \$89.95 Diskette/Disk.

**MICROCOMPUTER BOND PROGRAM**

(available for all computers)

MICROCOMPUTER BOND PROGRAM is designed to help you evaluate bonds. It provides a quick and easy way to estimate the prices and yields of fixed income securities under a broad range of assumptions and estimates about the future.

The price of a bond depends upon several factors including the risk of the issue, the interest it pays, the date it matures (or is subject to early call), the general level of interest in the market, and the expectations of the market for the future course of interest rates. The yield of a bond is influenced by the investor's tax rate, by the length of time the bond is held, and of course, by the price paid for the securities.

While MBP cannot help you predict the future, it can surely show you the results of any combination of circumstances you predict on the price of a fixed income security. And knowing that, you can make better decisions concerning the issues you invest in.

MBP provides:

Complete bond data entry, editing, listing and storage capabilities.

A flexible analysis environment, including market interest levels and tax rates.

Bond yields before maturity, showing estimated price, total dividends, and gross yield.

Bond prices estimated over time, at various market interest rates, evaluated to either maturity or early call.

Bond valuations, showing current yield, and before and after tax yield to maturity.

With MBP, the questions you have concerning the future performance of bonds can be answered quickly, easily, and with a minimum of work.

Cassette version requires 16K; diskette version 32K.

Price: \$55.95 Cassette  
\$59.95 Diskette  
\$62.45 Disk



**BUYSEL**

(CP/M and IBM only)

BUYSEL is suitable for both the curious beginner and the serious investor. It is a comprehensive software package for performing analyses of stocks, commodities, and options. It contains the following features:

- Four distinct trading methods and money-management systems, all of which produce explicit buy/sell transaction signals:
  - Moving Average Method
  - Price Channel Method
  - Buy Low, Sell High System
  - Dollar-Cost Buying System
- Black-Scholes call option model over any time period for a common stock.
- Statistical correlation computation between several stocks or commodities. This quantifies the degree of like behavior for different price actions over a common time period.
- Automatically scaled closing price charts requiring only a normal 24-line x 80-character video screen.
- Price data entry and validation on a daily basis, or quick approximation of long periods of real price data.

The inclusion of four different trading methods and



**IRMA**  
(Atari and IBM only)

Investment Records Management Aid (IRMA) is an easy-to-use, all-inclusive tool for everyone interested in financial, tax and investment planning. It provides convenience and efficiency for recording and tracking essential investment information and versatile, user-friendly methods to take advantage of this information for all of your planning requirements.

Pertinent data for a diversified portfolio of up to 90 different investments are entered quickly and easily. IRMA handles common stocks, preferred stocks, bonds, deposit accounts, funds, partnerships, options, taxable and non-taxable investments.

IRMA's varied presentations of your own data will support your decision-making in three major areas: financial planning, tax planning, and investment planning. Available aids include:

- Cash income forecast for any month.
- Annual income distribution by month.
- Cost-versus-value summaries.
- A complete history of all investment activity.
- Capital gains/losses summaries showing annual or year-to-date short- and long-term results.
- Income totals by investment and by type.
- Percentage distribution of portfolio by category.
- Investment value comparisons between dates.
- Records of shares owned, certificate numbers, income history, etc.

A printer is supported, but not required.

Price: \$49.95 Diskette

**RATIOS**  
(IBM only)

RATIOS was designed for the sole purpose of computing various financial ratios given certain standard financial data. It computes the ratios calculable given the data present. Included are the more popular ratios such as Net Operating Margin, ROA, ROE, Current Ratio, Quick Ratio, Debt Ratio, and Inventory Turnover. Also computed are ratios such as Times Interest Earned, Fixed Charges, Coverage, Funded Debt to Working Capital, Net Working Capital Turnover, Earnings per Share, Price Earnings Ratio, and numerous others. In all, 34 different ratios are evaluated.

Requires MS-DOS 1.0 or 2.0 and the BASICA Interpreter. You can save data on either a single-disk system, dual-disk system, or a hard-disk system.

Price: \$29.95 Diskette

money-management systems allows you to experiment and find the most suitable technique for trading a particular stock, option, or commodity. It also enables an investor to identify the technique that best matches his/her own investment objectives and style. Price charts show at a glance the price action for a selected price file over any chosen period of time. All transaction signals from the various methods are displayed on the charts as well.

Using a convenient menu structure with several HELP commands, BUYSEL has been designed to be extremely user-friendly and easy to operate. The documentation includes fully detailed operating instructions as well as an analytical description of all techniques and analyses performed.

Price: \$149.95 Diskette  
\$152.45 Disk

NOT AVAILABLE on single-density Osborne or single-density North Star CP/M diskettes — it contains 110K of programs! Requires MBASIC release 5.2 or higher (BASIC-80).

**OPTIONS ANALYSIS**

(TRS-80, Apple, CP/M, and IBM only)

OPTIONS ANALYSIS provides one of the most complete analyses available for PUT and CALL prices as a function of both stock price and time-to-expiration based on the principal investment strategies which one might employ. The analyses present information on the profit potential both in dollars and in annualized percentages (where applicable) for any desired range of stock price and time-to-expiration.

OPTIONS ANALYSIS is menu-driven, easy to use and is accompanied by a very professional manual which fully introduces the concept of options and "walks" the user through the various menu options. The basic program elements include determining the values of PUT and CALL options, PUT and CALL writing, spreads and straddles. Altogether six strategies are provided. The Black-Scholes formula is used for determining the values of CALL options. The primary strategy for call writing is "hedging", and is a subclass of the spreads strategy for the case in which the options only are sold.

Typical inputs to the program are (CALL writing case)

- Purchase price
- Number of shares
- Number of calls sold
- Percent interest
- Volatility percent
- Exercise price of CALL
- Price of CALL option
- Initial buy/sell date
- Option expiration date
- Stock price at which to begin computation
- Price increment, highest price
- Dividend information

The corresponding outputs are:

- Value of CALL and profit on the day the position was established
- Results of position on the last day

OPTIONS ANALYSIS features the ability to try other approaches so as to facilitate experimenting. An 80 column printer is supported. Requires 48K.

The CP/M version requires MBASIC release 5.2 or higher.

Price: \$99.95 Diskette



Price: \$99.95 Diskette

**THE PROPERTY MANAGER**

(IBM and Apple only)

Tired of keeping rental property records and still never knowing your exact financial position? If so, THE PROPERTY MANAGER is your solution. THE PROPERTY MANAGER is a totally integrated system that covers all facets of rental property management. It exceeds the recommended minimum standards for computerized property management systems as established by the Institute of Real Estate Management.

The tenant record for each unit includes the current and past occupant along with related information, such as monthly rent, amount due, security deposits being held in escrow, move-in date, lease expiration date, mailing address, and so forth. Cash receipts are entered directly from your bank deposit slip with all updating of the tenant's accounts and general ledger taken care of automatically.

Preparing billing statements is a breeze. Rents are taken directly from the tenant record. Additional charges, such as cleaning, security deposits, and parking fees can be added individually or to all accounts. Late payment charges are calculated based upon your management practices.

As invoices are received, they are entered into THE PROPERTY MANAGER's cash disbursement module. When the time comes to pay a vendor, a simple entry

pays the invoice and even prints the check (if requested). Throughout the operation, an audit trail is retained for each transaction. Anytime during the month, printed profit/loss, cash flow, and income statements are available. Journal correction capability is provided to handle non-cash transactions and to "fix" those little problems that inevitably crop up.

**Disk Capacity Specifications**

160K Disk: 125 rental units, 50 G/L accounts, 95 pending disbursements, 75 vendors, 375 G/L transactions.

360K Disk: 900 rental units, 150 G/L accounts, 235 pending disbursements, 170 vendors, 900 G/L transactions.

More than a dozen different reports, with most having several variations, are provided to give you a solid, hassle-free handle on your rental property.

**Requirements**

IBM Version: DOS 1.1, 2.0, or 2.1; 128K RAM; 2 double-sided floppy disk drives or a fixed drive; printer.

Apple Version: II+, II/e, or II/c, (II+ requires 64K RAM, lower case adapter); 1 or 2 floppy disk drives or fixed drive; printer.

Includes a very well written and easy to use 150-page manual.

Price: \$99.95 Diskette

**MONEY**

(CP/M only)

MONEY is a complete financial analysis computer program which can provide valuable assistance in managing your money wisely and making the most of your investments. It can be used to compute compound interest, analyze periodic savings or direct-reduction loans, determine an amortization schedule, or analyze depreciation for income tax purposes. Each of these many options have been combined into one easy-to-operate menu-driven computer program which can provide you great speed and flexibility in completing an in-depth financial analysis.

MONEY can help you evaluate how various compounding periods, different interest rates, different inflation rates, or various savings periods will affect your total or periodic savings. You can analyze with MONEY the effects which the loan payback period, various monthly payment options, or different interest rates will have in regard to the money you lend or borrow. In addition,

you can prepare an amortization schedule to evaluate the most effective way to manage a loan.

With MONEY you can quickly and effectively analyze the results of a real-estate sale, a short-term loan, or a long-term financial commitment. Many options can be quickly and easily analyzed to assure the best use of your method. MONEY will let you compare the results of various depreciation methods and help you choose the method and conditions which best suit your immediate application. In addition, a depreciation schedule can be calculated with copy available for your tax records.

Resourceful money management is the key to financial independence, but the key to being resourceful is knowing about utilizing the most up-to-date financial tools available. MONEY is one of the best comprehensive tools available to help you complete a careful financial analysis.

Requires 48K. Does not require MBASIC. A printer is supported, but is not necessary.

Price: \$29.95 Diskette

Price: \$29.95 Diskette

**THE VERSABUSINESS™ SERIES**

(All computers except Atari, C-64, and TRS-80 Model I)

For some time now DYNACOMP's research staff has been looking for a complete and coordinated accounting system available at a reasonable price. We believe we have found it in the VERSABUSINESS™ SERIES produced by Computronics. Many of you may already be familiar with this software; it has been heavily advertised in national magazines for the past year. With the addition of the new VERSALEDDER II™, this series is one of the best available (see the reviews).

DYNACOMP's relationship with Computronics has been exceptionally good. For the past two years Computronics has been advertising and distributing DYNACOMP products with considerable success. Now it's DYNACOMP's chance to return the compliment. (Note that we offer Computronics software at discount prices.) Note: Apple versions require two disk drives.

**VERSALEDGER II™**

(All computers except Atari, C-64, and TRS-80 Model I)

VERSALEDGER II™ gives you the versatility you need to set up your system the way you want it. With VERSALEDDER II™ you can:

- Maintain a check register alone, totally independent from the system's general ledger features.
- Run a general ledger alone, without setting up a check register.
- Run one or more checking accounts and a general ledger as a complete, integrated accounting system.
- Get an instant balance at any time.
- Distribute a single check to more than one account (unlimited multiple disbursements).
- Print checks, check registers, lists of outstanding checks, journal transaction registers, detailed and summary account listings, detailed and summary trial balances, check register posting reports, balance sheets, and income statements.
- Design and store your own formats for balance sheets and income statements!
- Coordinate your system with any of the other four independent modules of the VERSABUSINESS™ series to handle Accounts Receivables, Accounts Payable, Payroll, and Inventory.

VERSALEDGER II™ can take full advantage of your system's capacity. It can store up to:

- 615 accounts and 300 transactions per month on single-density 5¼" drives (TRS-80 Model I).
- 615 accounts and 2400 transactions per month on the TRS-80 Model III or IBM PC.
- 1000 accounts and 6000 transactions per month on the TRS-80 Model II.
- 615 accounts and 500 transactions per month on the Apple II.
- 1000 accounts and 3000 transactions per month on single-density 8-inch CP/M.
- Virtually unlimited capacity on hard-disk systems.

(The above figures are estimates—storage capacity depends on the configuration of your system.)

VERSALEDGER II™ is easy to learn and easy to use. The comprehensive 156-page user manual provides first-time users with a complete overview of the system, and clear, well-organized descriptions of every function of the system. After gaining some experience, you will still find the manual to be very useful as an excellent quick-reference guide to the system. The manual acts as a step-by-step instructional text that makes use of complete sample data files supplied on diskette and refers to 57 pages of sample reports. Even if you've never used a computer before, you'll be running VERSALEDDER II™ like a pro in just one afternoon!

Suggested List: \$149.95  
DYNACOMP's Price: \$129.95

**REVIEWS****Old Dossing, Dossing-Bantex Office Products**  
(about VersaReceivables 2.0)

"I would like to compliment you on the accomplishment of the above program.....stuffed with elegant features which, of course, I do not have to tell you about. What I can tell you about is which ones, I, as the end-user, appreciate the most: the possibility for the user (without any programming knowledge at all) to enter into the program the printer codes for changing the print pitch prior to report writing.....(and) the possibility of isolating the transactions of a user-defined group of customers (by account number) within a user-defined period of time (by date). This allows an easy distribution of sales commissions to the different sales reps by month, week, or any other period of time.....I could go on and on, describing the terrific features of this program....."

**COMPUTER BUYER'S GUIDE AND HANDBOOK,**  
#12, 1983 (about VersaPayroll)

"A hundred dollars couldn't possibly buy a good payroll package, could it? Don't be so sure.....VersaPayroll — at \$99.95 — may be exactly what you need. VersaPayroll handles weekly, bi-weekly, semi-monthly, and monthly periods. The program can print out all payroll checks and also allows for the creation of checks at any time. The report generating features of VersaPayroll is really where the program shines. The user can ask for a check register and payroll register at any time. Specialized reports, such as a quarterly earnings report and analysis that shows unemployment insurance liabilities, can also be requested at any time."

**John Ragan & Associates**

(about VersaReceivables and VersaInventory)

"Thought you would like to know the programs are performing well.....I operate a wholesale distribution business serving about 80 accounts and find the invoicing/inventory programs very helpful in reducing time to do these functions manually. The ease of executing the programs by following the easily understood prompts is also a definite plus. Your programs represent a good value in today's small business computer software."

**BARON'S MICROCOMPUTING REPORTS,**

June 1984 (about VersaLedger II)

"The VERSA stands for versatile, and this \$149.95 package is versatile. It allows you to set up a simple or multiple checkbook system in as simple or complex a manner as you desire. The design of this program is user-friendly, and little, if any, accounting knowledge is required.....The program comes with test data that allows you to get the feel of the program prior to organizing your real database.....this could be the complete accounting system for a small to medium-size business....."

**Jaye P. Jones Bookkeeping & Tax Services**

(about VersaLedger II)

"I can't compliment you enough on this program. It is versatile, easy, very professional.....we run it on many clients..... you can customize any financial statement with extremely professional looking results."

**PERSONAL SOFTWARE,**

November 1983 (about VersaLedger II)

".....an ideal accounting system for personal use or for the small entrepreneur who wants to keep good financial records without all the hassles.....VersaLedger II is easy for anyone to use the first time. One of the best features of VersaLedger II is that it's expandable. If you only need a checkbook register, VersaLedger II can provide it. If you need a general ledger to handle a handful of accounts, VersaLedger II can easily do the job. If you need a general ledger to manage several hundred accounts, VersaLedger II is there. VersaLedger II can be a welcome friend, handling all the posting and math and only asking you a few basic questions. The electronic bookkeeper is here in the form of VersaLedger II."



**VERSAINVENTORY™**

(All computers except Atari, C-64, and TRS-80 Model I)

VERSAINVENTORY™ is a complete, comprehensive, inventory control system that keeps track of descriptions, pricing, and vendor information for every item in stock, what is being sold (and removed from stock), what stock has been depleted to a user-defined reorder point, and what items are actually out of stock. VERSAINVENTORY™ also provides you with essential sales reports that tell you how well any particular product has been selling.

VERSAINVENTORY™ will:

- Allow you to instantly add to, or deduct from, inventory levels.
- Notify you when an item's stock level falls to reorder point (which you have previously defined).
- Store comprehensive data for every item in stock using item I.D. number, description, vendor I.D., vendor's item number, stock location, department, unit of sale, weight of unit, number of items in stock, number on back order, reorder level and quantity, items sold period-to-date and year-to-date, latest cost, average cost, last P.O. number and date, expected delivery date, standard and alternate selling prices, and sales period-to-date and year-to-date.
- Print all needed inventory and sales reports, including master inventory listings, items below reorder point, inventory value report, period and year-to-date sales reports, price lists, and physical inventory checklists.
- Allow you to enter and print invoices, automatically depleting stock levels.
- Integrate with VERSARECEIVABLES™ (when using the VERSARECEIVABLES™ invoicing system, VERSAINVENTORY™ files are automatically updated).

VERSAINVENTORY™ makes the most of your available disk capacity: to figure out the storage limitations of your system, multiply the number of kilobytes of disk storage available by 8; for example, a TRS-80 Model II disk will hold 500K, and will thus allow 4,000 inventory items on record. (This method provides an estimate only; actual capacity depends on the configuration of your system.)

The VERSAINVENTORY™ manual provides first-time users with everything they need to know to run the system. Whether you're running a retail store or a large warehouse, VERSAINVENTORY™ is perfect for controlling an inventory operation.

Suggested List: \$99.95  
DYNACOMP's Price: \$89.95

**VERSAPAYABLES™**

(All computers except Atari, C-64, and TRS-80 Model I)

VERSAPAYABLES™ is the complete accounts-payable system that will help you stay in touch with exactly how much your company owes, to whom, and when payments become due. VERSAPAYABLES™ stores a complete file of vendors and transactions, helps you select vouchers for payment, and can even print checks.

VERSAPAYABLES™ will:

- Keep complete information on each vendor.
- Keep track of current and aged payables.
- Let you quickly select vouchers for payment, or automatically suggest which vouchers should be paid.
- Allow partial payments of vouchers.
- Print checks and a check register.
- Print all needed summary reports, including vendor data and transaction reports, aged payable reports, open voucher reports, and automatic voucher selection reports.
- Print vendor mailing labels.
- Integrate with VERSALEDGER II™.

**VERSARECEIVABLES™**

(All computers except Atari, C-64, and TRS-80 Model I)

VERSARECEIVABLES™ is the complete accounts-receivable system that will handle your invoicing and billing operations and provide you with a clear picture of the flow of money owed to your company. VERSARECEIVABLES™ will store a complete history for each of your customers and show you who owes your company, how much, and which customers are delinquent in their payments.

VERSARECEIVABLES™ will:

- Keep a complete history on each account, both current and aged.
- Print invoices and statements on printed forms (available from New England Business Service).
- Allow you to enter invoices manually, or take product and pricing data from VERSAINVENTORY™ files.
- Generate periodic statements at any time.
- Bill your customers automatically (if desired).
- Allow partial payments on open invoices.
- Print all needed accounts-receivable reports, including complete transaction reports, customer data sheets, and detailed aging reports.
- Print customer mailing labels.
- Integrate with VERSALEDGER II™.

VERSARECEIVABLES™ maximizes the storage capacity of your system. It will store:

- 400 customers and transactions per month on 5¼" drives (TRS-80 Model I).
- 2400 per month on the TRS-80 Model III or IBM PC.
- 6000 per month on the TRS-80 Model II.
- 6000 per month on the Apple II.
- 3000 per month on single-density 8-inch CP/M.
- Virtually unlimited storage on hard-disk systems.

(The above figures are estimates—storage capacity depends on the customer-transaction mix and the amount of disk space available.)

The VERSARECEIVABLES™ user's manual (which includes complete sample report printouts) will help you get the system up and running quickly, even if you're a beginner. VERSARECEIVABLES™ is ideal for doctors, lawyers, and other professionals, small businesses, or large corporations. If your receivables system is giving you headaches, VERSARECEIVABLES™ is the cure!

Suggested List: \$99.95  
DYNACOMP's Price: \$89.95

Note: Apple versions require two disk drives.

VERSAPAYABLES™ maximizes the storage capacity of your system. It will store:

- 400 vendors and transactions per month on single-density 5¼" drives (TRS-80 Model I).
- 2400 per month on the TRS-80 Model III or IBM PC.
- 6000 per month on the TRS-80 Model II.
- 3000 per month on single-density 8" CP/M.
- 600 per month on the Apple II.
- Virtually unlimited storage on hard-disk systems.

(The above figures are estimates—storage capacity depends on the vendor-transaction mix and the amount of disk space available.)

With its complete set of sample report printouts, the VERSAPAYABLES™ manual provides clear and simple instructions to get your system set up and running. VERSAPAYABLES™ is the accounts-payable system designed for any business, large or small.

Suggested List: \$99.95  
DYNACOMP's Price: \$89.95

**VERSAPAYROLL™**

(All computers except Atari, C-64, and TRS-80 Model I)

VERSAPAYROLL™ simplifies your payroll operation by storing all of your employee records, automatically making all payroll calculations, and printing out paychecks and all government-required payroll reports. The user is in control at all times, with the power to verify and, if necessary, intervene and alter data on any employee's check before printing it, or to prevent a single check from being printed (which allows you to write out an employee's check by hand in advance). With VERSAPAYROLL™ you can say goodbye to those tedious time-consuming withholding calculations and process your payroll in minutes instead of hours.

VERSAPAYROLL™ will:

- Print paychecks one at a time, or print an entire payroll at once.
- Allow you to intervene and alter any figure on any paycheck.
- Give you an instant summary of any employee's year-to-date totals, or totals for all employees.
- Calculate all federal, state, and local taxes.
- Allow for all standard deductions, plus three miscellaneous deductions.
- Take amounts from different departments to form one

- paycheck.
- Print all government-required reports.
- Permanently store all payroll transactions.
- Integrate with VERSALEDGER II™.

VERSAPAYROLL™ maximizes your system's storage capacity. It will store data for:

- 300 employees on single-density 5¼" drives (TRS-80 Model I).
- 600 employees on a TRS-80 Model III or IBM PC.
- 1200 employees on a TRS-80 Model II.
- 500 employees on an Apple II.
- 600 employees on any single-density 8-inch CP/M system.
- Virtually unlimited capacity on hard-disk systems.

(The above figures are estimates—storage capacity depends on the configuration of your system.)

VERSAPAYROLL™ comprehensive user's manual is designed to guide even the most inexperienced user and includes complete sample printouts. Whether you have hundreds of employees or just a dozen, automate your system with VERSAPAYROLL™.

Suggested List: \$99.95  
DYNACOMP's Price: \$89.95

**PAYFIVE**

(Apple II 48K Diskette only)

If you run a small business with less than 150 employees and you have an Apple computer, then this program is a must. PAYFIVE is the most complete, flexible and easy to use payroll accounting package available. At every level of function, PAYFIVE offers superior features compared to other payroll accounting packages. Most important of all, these features are extensively documented in a 220 page reference manual that clearly outlines each step. However, the prompts within the program are so clearly presented that reference to the printed manual is usually unnecessary!

Examples of some of the flexible features included in PAYFIVE are:

- 1) Personnel may be paid on an hourly, commissioned or salaried basis, in any combination, and with any mixture for one employee.
- 2) You may define up to four special departments tailored to your accounting needs.
- 3) You may define vacation and sick time record keeping procedures.
- 4) Subtotals are kept on a monthly basis (as opposed to the quarterly totals available with most other packages).
- 5) You may define up to five optional deduction categories in addition to the usual standard deductions.

6) Federal, State, and Local taxes are compiled automatically, and reports are available for each. Each tax is user-defined. The documentation comes with State Tax Tables for each state to make the initial set up of the program straight forward.

7) Twenty-one different reports are available, including the printing of forms such as the W-2, 940, 941, and State Withholding Tax forms. PAYFIVE will even write checks if you wish!

8) Employees may be paid on a weekly, semi-monthly (both odd and even weeks), biweekly and monthly basis. Different employees may be paid on different bases.

This list does not exhaust the features which PAYFIVE offers. Perhaps the most important feature to mention is that there are special capabilities which will allow your accountant to do your records from the check stubs. This will ultimately save you enough in accounting costs to pay for the cost of the system many times over.

If you do not have an Apple for your business, PAYFIVE might even be enough reason to buy one. We recommend this product highly.

Requires two disk drives.

Price: \$149.95 Diskette  
Manual available separately for \$30.00

**LIFE CYCLE ANALYSIS AND DEPRECIATION**

(Apple diskette only)

This software package creates a data file of business expenses for equipment which can later be used to calculate and display a variety of reports. You may project annual costs, find the present worth, create depreciation schedules and justify tax deductions. The evaluation techniques conform to standards set by federal agencies. This is an invaluable package for any businessman who has invested in equipment. LIFE CYCLE ANALYSIS features an easy to use data file creation section and provides formatted hardcopy reports for use in presentations or for tax record keeping purposes. When used for generating tax information, this package is tax deductible! Requires 48K. Comes on two diskettes.

Price: \$39.95 Diskette

**AUCTION**

(Apple and Commodore 64 only)

AUCTION is a special program designed to help record, organize, and analyze auction bids. Each lot is identified by a lot number, description, and catalog value. The bidder information includes a bidder number, name, address, and date of bid. The bid information is entered as bidder number, lot number, and bid. The program identifies the highest bidder (and the next two highest), lot by lot, and shows summaries (lot number, bid, and total) for each bidder. All information is easily entered, edited, and stored on disk. Results may be displayed on the screen or printed.

AUCTION greatly reduces the time and effort involved in treating auction data. Apple version requires 48K. An 80-column printer is supported.

Price: \$69.95 Diskette

**SMALL BUSINESS INVOICER**  
(IBM only)

SBI has been designed especially for small businesses and is particularly suited to the following situations:

- Your invoices must show a lot of detail about what you bill — typically one or two pages.
- No two invoices are alike; some are long, some are short, and the content of each is not repeated.
- In addition to your time, you also bill for other things, such as out-of-pocket expenses, parts, or cost of goods.
- You want to customize each invoice, not force it to fit within a rigidly structured billing program.
- You want a system that is easy to learn and easy to use.

SBI was designed for businesses which charge for both time and expenses, work on a project basis, and need to show considerable itemized detail on their invoices. SBI is aimed at first-time computer users who need a friendly program that can also perform a task that is immediately useful to them.

Features:

- Variable-length formats
- Variable-content formats
- Menu-driven
- Full editing
- Job indexing
- 70-page manual.
- Very easy to use

The editing screens are particularly nice and contain work boxes, etc.

Requires 128K, 80-character (or wider) printer, at least one disk drive, DOS 1.1 or higher. Does not require BASIC.

Price: \$59.95 Diskette

**DECISION ANALYSIS**  
(CP/M and IBM only)

DECISION ANALYSIS will not make decisions for you, but it will help you better organize your choices and the factors involved, and, in turn, help you make *better decisions*.

DECISION ANALYSIS sees to it that you define the choices and criteria clearly, and supply ratings. Then it analyzes your ratings to show how each choice compares with all the others. The analysis is presented in three tables of paired comparisons:

- Table of advantages: How much the choices outscore each other.
- Table of Disadvantages: How much the choices are outscored by each other.
- Table of Best Choices: Which choices are superior to the others.

What you do is simple. You enter your choices, criteria, and levels of confidence. There are several options, including the weighting system, confidence levels, date printing, saving, etc.

DECISION ANALYSIS may be used as both a tool and as a training aid. To the latter end, a clearly written manual has been prepared which takes you step-by-step through an analysis session and includes helpful commentary.

**FREE SERVICE CONTINUES!**

If you have a problem with a DYNACOMP program, CALL US! The help is free of charge.

Many companies charge for telephone help. For example, Adam Osborne's new software company bills \$1.00 per minute, and Micro Pro charges \$2.50 per minute! We think that is unfair to the customer and speaks poorly of the industry. However, it does show that service is a very significant expense for software companies.

**BOOKKEEP**  
(CP/M CBASIC only)

BOOKKEEP is a general ledger and financial statement preparation program designed for small business use. It has a high degree of flexibility and is meant to be used by someone who has a strong familiarity with bookkeeping. BOOKKEEP will permit you to enter transactions, prepare formal financial statements, query account balances, close the books, prepare statements by company segment, and print out both ledgers and journals. The program employs a double entry bookkeeping system and can be used either on the cash (tax) basis or accrual basis.

The major account categories covered are current assets, property/plant/equipment, current assets, debt, equity, revenues, cost of sales, R and D, selling expenses, administration expenses and "other". Each of these categories is further broken down into several subcategories.

BOOKKEEP runs under CBASIC (which comes with many machines, such as the Osborne-1), and requires a printer, 56K.

Price: \$69.95 Diskette  
\$72.45 Disk

Requires at least 48K and one disk drive; a printer is supported, but optional. MBASIC release 5.2 or higher (BASIC-80) is needed.

Price: \$39.95 Diskette  
\$42.45 8-inch CP/M Disk

**TIMEMAP**  
(TRS-80 only)

TIMEMAP is a generalized hard-copy schedule generating program which may be used for a variety of purposes. Its main function is the generation of a printed bar-chart schedule, which may be used to graphically illustrate time-event relationships. Supporting functions of the program include a variety of printout formats, editing capabilities, data searching, and sorting of the data file. Typical uses for this program includes support of small engineering projects, illustration of various business activities and phases, illustration of production schedules, timing of component and equipment reliability testing, employee schedules, and so forth. Requires 48K and 80 or 132 wide printer.

Price: \$29.95 Diskette

**JOBMASTER**  
(TRS-80 and IBM only)

JOBMASTER is designed for supervisors, managers, and engineers who are responsible for managing small production and assembly programs. Typical examples would include machine shops, sheet metal shops, mechanical assembly areas, and electronic assembly areas. Practically any business involved in manufacturing or assembling a product can make use of JOBMASTER.

The JOBMASTER program allows the user to set up a data file describing each individual operation in the shop area, including the station, contract or project, task name and description, date, employee name and I.D., and shift. Also included is a cost breakdown which includes labor, material, and work station costs, as well as hours worked, projected production and actual production. Full data file editing capability is provided, as well as a very useful automatic updating command which provides easy data file maintenance and permits changes and updates to the data file to be made with great rapidity.

In operation, the program provides full sorting and searching capabilities, allowing the file to be sorted by any data category, as well as limited and global searching for keyword matches. Both text and numeric data may be searched and sorted.

A major feature of the program is the file evaluation command. This command can be used to compute costs and man-hours in a variety of ways. As an example, computation can take place on a station-by-station basis, a contract-by-contract basis, an employee-by-employee basis, or a date-by-date basis. In fact, the evaluation can be keyed to any of eight possible data categories. Costing information is provided on an item by item basis, as well as being totaled by category item.

The evaluation function features a pre-sort option, which allows the file to be sorted by a user selected category prior to the actual evaluation. This feature, along with the category selection options of the evaluation, provide a great selection of choices with regard to data presentation and evaluation results (approximately 64 variations).

JOBMASTER also provides a schedule generating feature. By appropriate selection of category, 8 different types of schedules can be created, such as a day-by-day schedule, contract-by-contract schedule, employee-by-employee schedule, and so forth.

Another feature of the JOBMASTER program is the ability to generate cash flow/man loading projections. Again, a number of options are provided to generate cash flow based on a number of possible categories, including contract-by-contract and day-by-day projections.

JOBMASTER's versatility lies in its ability to evaluate and output the contents of the data file in a number of different ways, providing the user with a maximum amount of data in a user-selected format. The user is thus provided with rapid access to vital information to aid in the scheduling, planning, and control functions of the production area.

JOBMASTER operates as a user-friendly program, providing menu-driven commands and prompts for all data inputs. Several convenience and data-verification features are also incorporated into the program to provide for ease of use. Error-trapping is provided to prevent data loss in the event of disk errors or similar problems.

Requires 48K, disk drive and printer.

Price: \$69.95

**CONTRACTOR MANAGEMENT PROGRAM**  
(TRS-80 only)

The CONTRACTOR MANAGEMENT PROGRAM (CMP) is a management tool designed to assist general contractors and related businesses in the processes of estimating, planning, scheduling, and controlling of the contracting business. The program has a large menu of functions which provide the user with cost, scheduling, and resource utilization information in a wide variety of formats.

In operation, the CMP provides for setting up of four data files containing information on equipment, personnel, materials, and contracted services. Each entry in each file contains information defining the name, site, location, task, function, cost, and scheduling of the item. Employee entries provide for overtime and doubletime considerations.

Utilizing the data files, the program provides standard searching and sorting functions, and supports multi-file chain operations.

An evaluation command provides the user with a number of options for evaluating cost. The entire file may be processed, or individual entries may be selected and processed. The evaluation command also includes a powerful category evaluation option, which allows the user to figure costs for all unique entries within a category. As an example, a file containing 30 entries for 6 dump trucks, covering 5 different sites and time periods for each truck, would result in the generation of 6 printouts, covering a complete cost evaluation for all entries pertaining to each truck. This command can be performed on a wide variety of categories, providing cost and utilization breakdowns in a large number of convenient formats.

CMP also includes a tracking command. This command allows the user to generate specialized data dumps by any data category. As an example, a printout can be generated to provide schedules for each piece of equipment or employee. Or a printout can be made to show activities at each work site, or to show resources assigned to each task. The track command operations on a number of data categories, providing the user with convenient and useful data in a wide range of possible formats.

CMP is a user-friendly, menu-driven program which prompts for each required input. Error-trapping is provided to prevent data loss in the event of DISK FULL and similar errors. Line printer output is supported, and is recommended for several of the program functions. Pagination and screen control is included to provide neat, easy-to-read printouts.

CMP includes data verification routines for data inputs and provides full data file editing capabilities. Additionally, a useful updating command is included to allow any data category to be rapidly updated without editing the entire item. This function is especially useful in using old data files to create new ones with a minimum of typing.

Requires 48K, one disk drive and a printer.

Price: \$59.95 Diskette

**COMPUTRONICS BUSINESS PAC 100**

(Apple, CP/M, IBM, and TRS-80 Model III/4 only)

This is the second, and perhaps the better known, of the two Computronics "100" software packages. This collection consists of 100 ready-to-run business programs. It includes a 128-page manual. Though originally distributed by Computronics, it is now also available through DYNACOMP (at a discount). The programs include:

- Interest apportionment by rule of the 78s
- Annuity computation program
- Time between dates
- Day of year a particular date falls on
- Interest rate on lease
- Break-even analysis
- Straight-line depreciation
- Sum-of-the-digits depreciation
- Declining-balance depreciation
- Double-declining-balance depreciation
- Cash flow vs. depreciation tables
- Prints RAPDIFORMS checks along with daily register.
- Checkbook maintenance program
- Mortgage amortization table
- Computes time needed for money to double, triple, etc.
- Determines salvage value of an investment
- Rate of return on investment with variable inflows
- Rate of return on investment with constant inflows
- Effective interest rate of a loan
- Future value of an investment (compound interest)
- Present value of a future amount
- Amount of payment on a loan
- Equal withdrawals from investment to leave 0 over
- Simple discount analysis
- Equivalent & nonequivalent dated values for oblig.
- Present value of deferred annuities
- Percent markup analysis for items
- Sinking-fund amortization program
- Value of a bond
- Depletion analysis
- Black Scholes options analysis
- Expected return on stock via discounts dividends
- Value of a warrant
- Value of a bond
- Estimate of future earnings per share for company
- Computes alpha and beta variables for stock
- Portfolio selection model, i.e., what stocks to hold
- Option-writing computations
- Value of a right
- Expected-value analysis
- Bayesian decisions
- Value of perfect information
- Value of additional information
- Derives utility function
- Linear programming solution by simplex method
- Transportation method for linear programming
- Economic order quantity inventory model
- Single-server queueing (waiting line) model
- Cost-volume-profit analysis
- Conditional profit tables
- Opportunity loss tables
- Fixed quantity economic order quantity model
- As above but with shortages permitted
- As above but with quantity price breaks
- Cost benefit waiting-line analysis
- Net cash flow analysis for simple investment
- Profitability index of a project
- Cap. Asset. Pr. Model analysis of a project
- Weighted average cost of capital
- True rate on loan with compensating bal. required
- True rate on discounted loan
- Merger analysis computations
- Financial ratios for a firm
- Net present value of project
- Laspeyres price index
- Paasche price index
- Constructs seasonal quantity indices for company
- Time series analysis linear trend

- Time series analysis moving-average trend
- Future price estimation with inflation
- Mailing list system
- Letter-writing system which links with above
- Sorts list of names
- Shipping label maker
- Name label maker
- DOME business bookkeeping system
- Computes week's total hours from timeclock info.
- In-memory accounts-payable system, storage permitted
- Generate invoice on screen and print on printer
- In-memory inventory control system
- Computerized telephone directory
- Time use analysis
- Use of assignment algorithm for optimal job assign.
- In-memory accounts receivable system
- Compares 3 methods of repayment of loans
- Computes gross pay required for given net
- Computes selling price for given after-tax amount
- Arbitrage computations
- Sinking-fund depreciation
- Finds UPS zones from Zip code
- Types envelope, including return address
- Automobile expense analysis
- Insurance policy file
- In-memory payroll system
- Dilution analysis
- Loan amount a borrower can afford
- Purchase price for rental property
- Sale-leaseback analysis
- Investor's rate-of-return on convertible bond
- Stock market portfolio storage-valuation program

**Price**

System	List Price	DYNACOMP's Price
TRS-80, Apple, Atari, Commodore, diskettes	\$ 99.95	\$ 89.95
5 1/4" CP/M and IBM diskettes	\$149.95	\$129.95
8" CP/M disk	\$149.95	\$129.95

**POPULAR COMPUTING,**

May 1982 (about Business Pac 100)  
 "Business Pac 100 is an excellent collection of cost-effective business programs....the programs perform admirably and are definitely user-friendly....Business Pac 100's 110-page user's manual completely details each step of every program in a highly readable fashion.... simple to follow and a pleasure to use."

**PROJECT CONTROL ONE**

(TRS-80 and IBM only)

PC1 is a basic project control and scheduling program designed for engineers, managers, builders, and other supervisory personnel who have responsibility for project management. The program provides numerous options and capabilities for obtaining a maximum amount of useful information with a minimum amount of input data. The program does not require the use of CPM or PERT techniques, (or familiarity with them) and was designed for projects whose size and nature do not necessitate a rigorous application of these methods. The program provides user-friendly menu selections for the command functions, and supports hard-copy output as well as CRT display. A printer is highly recommended, as the printed task/event charts and percent complete charts are printer-only functions. Both 80 and 132 column printers are supported, including selectable density types.

Price: \$49.95 Diskette

NOTE: The IBM version requires 128K of RAM, a parallel printer port, and two double-sided floppy drives (or one double-sided drive and a hard disk).

**FINANCIAL MANAGEMENT SYSTEM**

(North Star, CP/M, and IBM only)

This is one of the most complete financial analysis packages available today. In addition, it is not simply a collection of programs, but rather a highly organized menu-driven set of coordinated subprograms which are a pleasure to use. Some of the topics covered are:

- Financial Ratios (liquidity, leverage, activity, profitability)
- DuPont Analysis
- Break-even Analysis
- Lease-Buy Decision
- Net Present Value
- Rates of Return (internal, modified, adjusted)
- Profitability Index
- Inventory Model (Economic Ordering Quantity Model)
- Capital Budgeting Under Uncertainty
- Refunding a Bond (value of a right, over subscription allocation, cumulative voting, stock dividends)
- Stock Valuation (perpetual bond, preferred stock, short term bond, common stock, rate of return, stock value)
- And more

Comes complete with a very well written and nicely organized instruction book (over 160 pages). Requires 48K. An 80 column printer is supported.

Price: \$149.95 Diskette

\$152.45 Disk

Sample display:

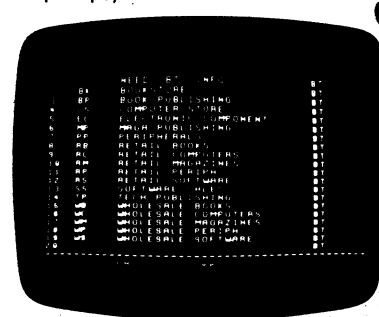

**EASY RECORDS II**

(Atari and IBM only)

EASY RECORDS II is an easy-to-use, yet powerful financial records keeping package for the Atari family of computers.

Up to 55 tracking files may be created (e.g., an expense track, receipt track, etc.). You are also provided with a "net-to-date" file of expenses and receipts, a separate depreciable item expense track, and several special function keys to retrieve the most often used information. For example, pressing the "=" key will bring up the year-to-date figures for expenses, receipts, and net.

You can also have a hard copy of all files on a monthly or yearly basis. For example, on the expense file report, the check number, date, amount, purpose, and payee will be reported.

Each data disk can hold 300 transactions (minimum), and data can be carried over from disk to disk; the amount of storage is unlimited.

**SKILLS INVENTORY**

(IBM only)

SKILLS INVENTORY is a database program written specifically for employment agencies, contract programming companies, and personnel departments of companies wishing to maintain a file of job candidates and their associated characteristics.

Once information about prospective candidates is entered, specific job requirements can be specified, and the database searched for candidates who meet those requirements.

The following information is recorded:

- Education.
- Willingness to travel.
- Willingness to relocate.
- Defined search criteria: Up to 300 skills or other search parameters can be entered, with up to eighteen assigned to each candidate. Each of the assigned skills can also have one of the following experience levels assigned to it:
  1. Training only.
  2. Light experience.
  3. Medium experience.
  4. Heavy experience.
  5. Experience not applicable.

These same characteristics are used for candidate searches.

The Candidate File includes such information as the candidate's current position, work phone, home phone, a record of interviews, the account executive assigned to the candidate, and two user-defined fields, in addition to the job characteristics mentioned above.

Other features include:

- A built-in word processor which allows you to type in letters, print them immediately for specific candidates, or save them on disk for later mass printing for selected candidates.
- The ability to print name and address labels for selected candidates in ZIP Code sequence.
- Menu-driven, with on-screen help information.
- There are no skill codes to memorize; you simply enter the descriptions.

Requires 128K of RAM, hard disk, or dual-floppy. A printer is recommended, but not required. BASIC is not needed.

Price: \$149.95 Diskette

EASY RECORDS II has been carefully designed to be "user friendly". It is menu driven and error trapped. The manual is clear (it even includes quizzes!). Also supplied is a training disk for learning the basics.

A common concern expressed by those new to computers is the difficulty in creating the initial records required to set up EASY RECORDS II for their particular business (since EASY RECORDS II is so flexible, you must define some of the functions, formats, etc.). The authors have responded by providing assistance in the form of data entry templates which greatly simplify computerizing your existing records.

To sum up, EASY RECORDS II is flexible, easy to learn, easy to use, and inexpensive.

Requires 48K, and one disk drive. Supports a printer (not required, but recommended).

Price: \$59.95 two Diskettes

The IBM version requires DOS 2.0 (or higher), BASICA, two drives, and 128K of RAM.

**OPTIMAC**

(TRS-80 and Apple only)

OPTIMAC is a work-day simulation for machines. Its purpose is to maximize the overall output of interrelated production equipment. The optimization is based on four different machine relations commonly found in agriculture, construction, transportation and industry. A maximum of 12 machines of three different types can be processed in each simulation for a total of 36 machines. Once the relations, machine types and other data has been entered, OPTIMAC will simulate an 8 hour work-day (at 2 minute time-increment intervals), for these conditions and quantities. The resulting simulated work-day is displayed graphically and numerically. A simultaneous graphing option is available in the program. This option is designed to help the user visualize the case being considered. OPTIMAC can also do repetitive simulations to find the best possible combination of machines in an optimization routine for minimizing idle machine time.

Cassette version requires 16K. Diskette version requires 32K.

Price: \$39.95 Cassette  
\$43.95 Diskette

**DATEBOOK**

(CP/M and IBM only)

Here is a datebook software package which is both very effective as well as exceptionally easy to use. You enter the date, from/to, subjects and comments. The date can be anything legal; DATEBOOK contains a perpetual calendar. The from/to can be the hours of the meeting, or can be names (from John Smith to Jim Jones). The subject is your choice (lunch, staff meeting, date, etc.). The comments may be descriptive (e.g., "discussion of the state of product XYZ"). You can freely search and sort on any of the above categories. For example, you may want to look up all memos to Jim Jones, or lunches between 1 and 3 pm ("I remember going to lunch with him between 1 and 3, but what was his name?"). You may easily add information, edit, search for word/phrases and sort on any category. Includes many features which specifically minimize the time spent on date entry. Comes complete with a 32 page manual which clearly describes program operation and sample uses. Requires 48K, printer optional. An ideal package for managers.

Price: \$29.95 Diskette  
\$32.45 8" Disk

**INVENTORY CONTROL**

(IBM only)

If you are concerned about popular items being out of stock, how much money is tied up in inventory, or inventory records showing goods that aren't even in stock, then you should try INVENTORY CONTROL.

INVENTORY CONTROL will allow you to value all inventory items at either the average cost or the last price paid. It will sort into descending order and print the total inventory value. In addition, besides the normal functions of adding and deleting on-hand amounts, INVENTORY CONTROL will give you the option of printing summary information for all parts of the system, or detailed information on a selected part basis.

Other features include the option to print a historical report showing the usage or sales for all parts over the past 12 months on a month-by-month basis. This could show you trends or seasonality factors. This report also indicates the total usage over the past 12 months for each part and sorts the data in descending order of use or sales to show you fast and slow sellers.

A reorder report is also available. It prints those items whose on-hand amount is equal to or less than the established reorder level for that part. Pricing information for each part can be displayed through a series of price reports based either on average cost, last price paid, or current selling price. These price reports can be sorted according to your needs.

You are allowed, in most fields, either numeric or alpha information. For example, if you did not know the amount received three months ago, you could enter NA rather than a numeric amount. Another nice feature is that you are given the option (in most cases) either to send the report to your terminal for display, send it to your printer for a hard copy, or both.

The documentation includes a complete set of program listings for those who may wish to customize the package.

System requirements include an IBM PC, 128K of memory, DOS 1.1 or above, two disk drives, and an 80-column printer. With single-sided disk drives the system capacity is 650 parts.

Price: \$59.95 Diskette

**PROJECT TIME REPORTING SYSTEM**

(CP/M and IBM only)

PROJECT TIME REPORTING SYSTEM (PROJTIME) is an easy-to-use data-base system designed specifically for accumulating, distributing, and reporting hours spent by employees on individual projects.

PROJTIME allows you to set up data files containing time-distribution data for up to ten projects. An unlimited number of individual files, each with up to ten projects, can be created and maintained. PROJTIME will record hours for up to twenty employees on each project, and can be used to produce three printed reports:

- Project Data Sheet: a detailed report for each project, showing basic project data such as project number and name, name of manager and supervisor, estimated and actual target dates, and a summary (by employee) of cumulative hours spent to date.
- Direct Hours Report: a list, by project, showing the hours charged by each employee during the latest pay period.
- Employee Hours Summary: a list, by employee, showing the cumulative hours spent by each employee on each project.

PROJTIME is completely menu-driven, and prompts the user at every step in the process of setting up or editing each file, entering data, and producing printed reports.

PROJTIME requires 64K of RAM, two disk drives, and a general 80-column printer. Does not require BASIC.

Price: \$39.95 Diskette

**OPERATIONS RESEARCH TUTORIAL**  
(Apple and IBM only)

The DYNACOMP OPERATIONS RESEARCH TUTORIAL package is a collection of 17 menu-selected programs which provide data file creation, manipulation, and calculation capabilities in support of the analysis of Payoff Tables, Simplex Linear Programming, Distribution/Transportation Methods and CPM/PERT analysis. The programs and accompanying documentation are aimed at the individual who would like to learn about these methods as well as use them in his or her job or business. The manual includes not only instructions on how to use the programs, but also illustrative examples which the user may practice with. The programs and documentation are broken into four basic sections.

The Payoff Tables section provides a *State of the World/Alternative Decisions* matrix which can be examined under the following criteria:

1. Certainty
2. Risk
3. Uncertainty
  - a) Laplace equiprobable futures
  - b) Wald minimax/maximin
  - c) Plunger
  - d) Hurwicz coefficient of optimism
  - e) Savage lost opportunity

In essence, you are supplied an evaluation of the possible choices in a way which suits your risk-taking posture.

The Linear Programming section provides an easy-to-use linear optimization. The program not only iteratively seeks the optimum subject to the constraints you have provided, giving the value of the objective function at each step, but also displays the *dual solutions* (sensitivity of a change in each constraint), cost ranging tables (amount variables may be changed without affecting the position of the optimum) and the resource sensitivity table (how far the supply of a particular resource or constraint can vary before the solution is affected). These outputs very effectively tell you how to operate your plant, mix your portfolio, etc., and what variables to watch in particular.

The Distribution/Transportation Methods section uses the linear programming technique to deal with supply/demand problems. Given the cost or profit associated with each channel between suppliers and consumers, the overall distribution mix may be optimized and the total cost/profit determined.

The CPM and PERT section requires some prior knowledge of drawing scheduling diagrams, or "bubble charts". The program takes the data from these charts, organizes it, and helps provide a critical Path Management or Program Evaluation and Review Technique analysis. Since the CPM and PERT data structures are similar, means are supplied for converting data files between the two, as well as general editing. With this program you may establish the critical path, examine the likely range of completion times, "crash" the critical path, examine slack time effects, project cost, and sort by project parameters. The program does not plot the chart — you must do that. However, given the chart and this program, you will be in a very good position to analyze the project and its sensitivities.

Requires 48K and one disk drive.

Price: \$99.95 Diskette

Sample display:

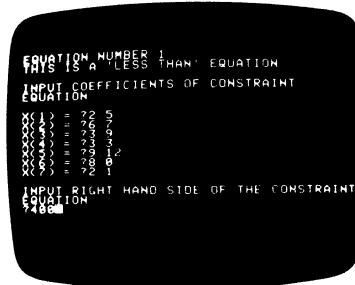
**VIDEO RENTAL MANAGEMENT SYSTEM**

(IBM only)

If a club member came into your store to rent a movie, would you know immediately how many past-due tapes that member has in his possession? Or, if a member came to you and said that he or she had just seen "Manhattan" and wanted to see other movies that Woody Allen has directed and starred in, would you be able to quickly provide a list?

As the demand for video tape rentals increases, it's likely that you will encounter many similar situations. Ideally, you would like to be prepared to cope with those situations *without* sacrificing time and manpower.

VIDEO RENTAL provides the management solution for the growing video rental store.

**Features include:**

- Invoice at time of rental — Just enter the account number (if a member) and the video number(s) and a full invoice is printed. Also, the rental is recorded on disk. There is also room for additional charges and credits.
- Tape Library Maintenance — capable of listing (and printing) the videos by numerous categories (i.e., VHS/BETA, title actor, director, rating, etc.)

- Automatic past-due calculation upon return.
- Customer's club membership information, including name, address, phone number, and membership date.
- Availability of video tapes (in inventory) on rental! etc.)
- Library sorting.
- Automated waiting list.
- Mailing labels printed by range of members, membership dates.
- ID card printing.

These are in addition to other features which you will find helpful in the daily operation of your business.

By automating your store with VIDEO RENTAL, you will greatly reduce the effort involved, and improve your service to your customers.

Requires 128K of RAM, two floppy drives (or one floppy and one hard disk), an 80-column (or wider) printer, and BASICA (or GWBASIC for "compatibles").

Price: \$99.95 Diskette

**BUSINESS TRACKER**

(Commodore 64 only)

If you operate a small service business, BUSINESS TRACKER will cut your bookkeeping, organizing, and secretarial chores. Whether you write, babysit, draft resumes, clean homes, shovel snow, entertain, consult, perform ... if you're paid by the hour, the word, the assignment, or in a similar way for your services, BUSINESS TRACKER will be a handy helper.

BUSINESS TRACKER records your employers and jobs and takes care of all the financial details. It works with a variety of printers to generate personalized bills, statements, receipts, or mailing lists and labels. It records the tax status of your pay and prints detailed lists of your employment either by date or client — for your reference or for tax purposes.

BUSINESS TRACKER is menu-driven. Enter an employer record once and you'll never need to re-enter it again or re-type a business address. The program allows you to change, add, or delete any detail, display employer status on screen or printer, and quickly track payments and balances.

Each data file can hold up to 90 assignments/employers, and up to 10 data files may be saved per disk. BUSINESS TRACKER also contains a DOS wedge for displaying the disk directory, and works with the Commodore DOS wedge for other disk operations.

Data files may be customized with the name, address, and a short description of your business. This information will be printed on all bills, receipts, statements, and job lists. These printouts add a professional look to your service.

Price: \$49.95 Diskette

**FLEET CONTROL**

(IBM only)

FLEET CONTROL will help you reduce the operating costs for your fleet of vehicles. It was originally written for a university with 38 pick-up and panel trucks. In twelve months it has helped that university save over \$10,000 in gasoline costs alone.

FLEET CONTROL is menu driven and contains three databases:

- Vehicle Lookup Database: vehicle number, maker number, serial number, type of vehicle, registration, and inspection dates. This database is also automatically accessed by the other functions.

- Gasoline Database: consumption of oil and gas for each vehicle, driver's name, service station. The monthly printouts let you determine which vehicles are most economical, and where the good gas stations are. Excess mileage (personal use) can often be found by using these reports.

- Repairs Database: type of repair, date, name of garage, driver's name, expense. End-of-service conditions may be found in the monthly updates, as well as repeat repairs, driver patterns, and garage prices.

Requires DOS 2.1 or higher, 128K of RAM, a 132-column printer, dual 360K drives, or one 360K drive and a hard disk.

Price: \$99.95 Diskette

**FOR THE BEST PRICES ON EXCELLENT QUALITY DISKETTES, SEE OUR SUPPLIES SECTION. WE DO NOT SELL THE REJECTS, SECONDS, OR REDUCED SPECIFICATION DISKETTES WHICH ARE NOW BEING SOLD AT "AMAZINGLY" LOW PRICES. THEY ARE NOT SO AMAZING IN QUALITY!**

**INVENTORY MANAGEMENT SYSTEM**

(TRS-80 Model III/4)

The INVENTORY MANAGEMENT SYSTEM provides you with effective and economical inventory control. It is designed for use in small to medium sized companies. IMS improves service, reduces costs, and increases profit potentials. It is appropriate for situations in which it is important to know what is in inventory, but is not intended for cases involving high turnover of numerous low priced items. Ideal applications include furniture and appliance stores, or small businesses handling only a few hundred products.

IMS includes proven inventory analysis methods, generates reports for inventory decisions, and assists in profit planning. In addition to determining your purchasing needs, IMS shows profit potentials, sales transaction summaries, inventory evaluation, and parts-on-order information. One unique feature is a method that determines whether the overhead cost of maintaining an item in inventory is more than its potential profit (time for a close-out sale!). The goal of IMS is to maximize your profits!

Features:

- Updates the inventory based on current period transactions.
- Summarizes revenues and quantities of sales, orders placed, and goods received.
- Details current purchasing needs.
- Calculates potential profit based on inventory, overhead, and expected sales.
- Shows the number of periods of supply that the current inventory level represents.
- Evaluates inventory wholesale costs, retail values, and cost of goods on order.
- Provides sales forecasting.
- Highlights parts currently overstocked.

Typical parts data stored are part number, vendor part number, description, cost/unit, price/unit, quantity in stock, sales rate, desired inventory level, on-order quantity, order date, vendor code, etc. Included is a very carefully prepared, "user friendly" manual (60 pages).

Requires at least 48K of RAM, an 80-column (or wider) printer, and two disk drives.

Price: \$99.95 Diskette

**EXECUTIVE PHONE/MAILER**

(IBM only)

EXECUTIVE PHONE/MAILER is a very convenient and easy to use database system for maintaining addresses and phone numbers. In addition to the normal address information, you can include company name, home and office phone numbers (including area codes), and a one-line comment. You have flexibility in setting both the address "field" widths as well as label width (one-up or two-up labels) and spacing. Labels can be printed alphabetically by name, by selected city or state, by area code, or in ZIP Code order. Multiple labels for a selected person can also be printed.

Phone numbers may be easily found by choosing an alphabetical letter in the database, and "paging" through the entries starting with that letter.

Extensive use is made of cursor positioning to make data entry and editing fast and easy, as well as simple to learn. Includes a 36-page manual which discusses all options and gives examples (you probably won't even need this manual!).

EXECUTIVE PHONE/MAILER requires 128K of RAM, DOS 2.1 or higher, a parallel printer port, two double-density disk drives, or one drive and a hard disk.

Price: \$29.95 Diskette

**CLIENT/SALES MASTER**

(IBM only)

CLIENT/SALES MASTER is one of the most useful and powerful tools available to you. Here are several good reasons why you should use CLIENT/SALES MASTER:

- Track your clients and prospective clients.
- Easily maintain client/customer list.
- Print mailing labels (one to four across).
- Compiled programs for super-fast performance.
- Assign as many as 40 different classes or types to each address or person that you have defined.
- Unlimited number of files or addresses (limited only by available disk space).
- Print all reports and labels in either alpha sequence or by ZIP Code.
- Select the addresses to be used by 40 different codes or address types defined by you.
- Menu driven for easy learning and for easy use.
- Hard copy (a report) of your clients/customers.
- Have a report or labels printed based on certain qualifications (e.g., name, address, city, state, ZIP, and any of 40 different classifications).
- Display this information immediately on your computer screen: search.
- Have mailing labels printed for your client/customer promotions including selections based on types or qualifications.
- Allow for duplicate names and addresses.
- Use 10-digit ZIP Codes.
- Browse through the address file (either forward or backward).
- Print address lists either complete or abbreviated.
- Use with either diskette or hard disk or both.
- Capture the company name or title of the individual which prints on the labels or reports).
- All searches and print selections can be global (i.e., you can find all customers with the last name beginning with the letter "D" in all ZIP Codes beginning with "50").

**CUSTOMER PROFILE**

(TRS-80, CP/M, and IBM only)

CUSTOMER PROFILE provides an easy way to keep track of current and prospective customers according to business type, services or products provided the customer, and assigned sales representative or territory.

CUSTOMER PROFILE is extremely flexible and accommodates the unique ways business is conducted. For example, data files can be quickly sorted to present reports in a sequence appropriate to management requirements. Additionally, the system codes can be redefined to meet the special needs of any company.

CUSTOMER PROFILE uses a customer data file and three tables.

The customer data file contains:

- Customer name and address
- Customer telephone number
- Sales contract
- Customer status (customer or prospective customer)
- Business type
- Sales code (user defined)
- Territory/representative assignment
- Product/service
- Date of the most recent sales call

The tables are:

1. Business Type

**Example 1:** You are an automobile dealer and you would like a report of all your repeat used-car clients that do not use your service department. You would also like to have mailing labels for a service promotion you will be having for these people. And, of course, you want a report and labels for your service customers that did not buy their auto from you.

It would also be nice if you could have a list of all your customers for a specific salesman and specific type of automobile.

**Example 2:** You are the sales manager for a manufacturing company and you need a list of all clients of a specific salesman. You need monthly reports of your customers printed by the sales territory that your salesman will be (or should be) calling on.

**Example 3:** As the manager of an employment agency, you have an employer on the phone who wants to know (right now) if you have any prospective employees that are willing to relocate, have a degree in engineering, and had a G.P.A. of over 3.50.

**Example 4:** As the personnel manager, you need a report of all your employees who have a review date coming up during the next month. You also need reports that show which employees have life insurance, which ones can operate an adding machine, and all employees over the age of fifty (and who have not used any sick time in the last six months).

**Example 5:** As a not-for-profit organization, which of your contributors gave during the last year to your fund for hunger; who gave over one thousand dollars; and who gave over five thousand; and, perhaps most important, which contributors didn't fit into these categories? Of course you need the labels for mailing.

CLIENT/SALES MASTER can do all of the above. What is your application?

Requires DOS 2.0 or higher, a printer, and 128K of RAM. A 20-page manual is included.

Price: \$59.95 Diskette

**THE SALES ASSISTANT**

(IBM only)

THE SALES ASSISTANT is designed for the salesperson who wishes to track important client information. The three main components are:

- CLIENT INFORMATION: You can store client name, address, phone number, contact person, next call/visit date, last sale/sale date, running total of sales, product type, credit rating, and account number. This database may also be printed several convenient ways.

- CAMPAIGN SCHEDULING: Use this to plan a sales campaign schedule. Includes a graph.

- MAIL LABELS: You may select single or double wide format. Using the CLIENT INFORMATION database, you may create labels according to the following six choices:

1. Entire database
2. By selected client
3. By selected city
4. By selected state
5. By selected ZIP Code
6. By selected area code

Requires DOS 2.1 (or higher), 128K of RAM, 132-column printer, dual 360K drives, or one 360K drive and a hard disk.

Price: \$59.95 Diskette

2. Assignment
3. Products and Services

Comes complete with an exceptionally well prepared instruction book (50 pages).

Price: \$59.95 Diskette



**PERSONAL TASK MANAGER**

(IBM only)

The PERSONAL TASK MANAGER is a personal task organizer and time-management tool for the person who needs to get more done in less time.

At its most basic level, PTM allows you to enter your most important "Things To Do Today"; to rank in order of priority; to sort according to ranks; to save in a file; and to display the list on a printer. You may (optionally) list the estimated time that each task should take and the projected starting time; the finishing time will be automatically calculated and displayed.

Should tasks or priorities change, you may recall the original list to the screen and add or delete items, change priorities, or alter the time estimates. Similarly, on the following day, a new list may be generated from scratch or by modifying the previous day's list.

For long range planning, PTM allows you to generate, sort, save, and print "Future Tasks" lists with optional projected starting and/or finishing dates.

PTM is useful to anyone who needs a convenient way to organize daily (and long-range) tasks, prioritize them, and to estimate, schedule, and control the amount of time each task takes. Since PTM may be used to organize the activities of one or many individuals, it should be particularly useful to supervisors, professionals, students, homemakers, and other task-oriented individuals.

PTM has been designed to allow quick throughput with maximum flexibility. Easy-to-read screens, automatic help messages, and clear option and error messages make PTM essentially self-documenting. However, a complete illustrated user's manual is provided to guarantee ease of use for the novice as well as the experienced computer user. Furthermore, the 35-page User's Guide provides a brief, helpful discussion of time management principles.

Requires 96K of RAM, at least one disk drive, and a printer. Does not require BASIC.

Price: \$39.95 Diskette

**ADAM  
AUTOMATIC DECISION ASSISTANCE  
MANAGER**

(Atari only)

ADAM is not a game. Rather, it can help you make logical decisions about almost any kind of problem.

ADAM is based upon the classical management decision grid. This popular conceptual tool facilitates decision making involving many conflicting elements. With ADAM you can center your thinking on the issues involved and how you feel about each one of them. The computer takes care of the mathematics. It even calculates a level of confidence for its suggestions.

Three different versions of ADAM are provided. One is written in Atari BASIC, another in Microsoft BASIC, and a third uses both Atari BASIC and "SAM", the software speech synthesizer. You must have a copy of "SAM" to use the features of this third program.

The ADAM manual describes each step of this easy-to-use program. There is also an appendix which explains some of the similarities and differences between Atari and Microsoft BASIC.

No computer program can insure that every choice you make will be the right one. However, if you accept ADAM's help, at least you will know that your decision was based upon a good examination and comparison of the issues.

Price: \$19.95 Diskette

**MIND PROBER**

(by Human Edge Software)

(Apple, IBM, and Commodore 64 only)

MIND PROBER is one of several Human Edge Software personal-interaction analysis packages which have received quite a bit of publicity in the news media. These packages are designed to help executives relate to, get along with, and even manipulate those with whom they must deal daily.

MIND PROBER works by asking specific questions; then it prepares a report. *Infoworld* reviewed it and said:

[MIND PROBER] promises to make 1984 a reality.

They tried to analyze Ronald Reagan, with the following results (an excerpt):

Mr. R. R. is driven more than others to be around people. He often thinks about being the center of attention, or being important to others. This person would love to be an actor, a politician, or something else that would give him center stage and national prominence.

While he may get angry quickly, Mr. R. R. can become upset by conflicts with other people. When he gets into an argument, you can expect him to end up apologizing for his short fuse. Open aggression usually bothers him. He would rather give in to an adversary than behave in a socially improper way and potentially damage his reputation.

MIND PROBER will help you to:

- Understand why someone behaves as he does.
- Accurately predict what someone will do in a given situation.
- Learn to interpret another's nonverbal clues.
- Discover the things most people are afraid to tell you about themselves.
- Have a scientifically accurate personality profile of anyone—in minutes.
- Sharpen your perceptions and communication style.

In addition, MIND PROBER is quick and easy to use.

Price: \$44.95 Diskette (Apple, IBM)  
\$29.95 Diskette (Commodore 64)

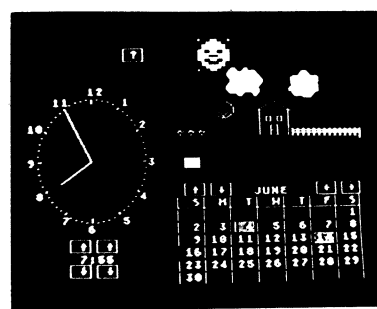

**TIME MASTERS**  
(See EDUCATION - YOUNG)

**FOR THE BEST PRICES ON EXCELLENT QUALITY DISKETTES, SEE OUR SUPPLIES SECTION. WE DO NOT BELL THE REJECTS, SECONDS, OR REDUCED SPECIFICATION DISKETTES WHICH ARE NOW BEING SOLD AT "AMAZINGLY" LOW PRICES. THEY ARE NOT SO AMAZING IN QUALITY!**

**KEEP TRACK OF IT**

(CP/M only)

Many middle and upper income families have purchased a computer with the idea that it would help them keep track of their financial records. However, the idea has often remained an idea because the available programs took hours to set up and were slow in execution. Now there is a very fast and very easy solution.

KEEP TRACK OF IT (KTOI) is a budget program that can be set up in two hours by a computer novice. It organizes your finances and gives you a printer network statement each month that shows all your assets and your liabilities. It also presents a monthly report of income and expenditures by category. A similar report can be generated for the year to date.

KTOI can handle up to 210 accounts (or categories of expenses and income). There can be up to 210 checking (or savings) accounts. For example, you and your spouse may have checking accounts, charge accounts, business accounts, savings accounts, IRA accounts, certificates of deposit, money market accounts, and other family members may have their own accounts.

The transactions can be marked for later selective recovery based on tax or other factors of your choice. At the end of the year the program will prepare a disk for the next year's data and will carry the balances in each account to the new year.

This program is not written in BASIC and executes very quickly. For example, it takes less than a minute to find the last transaction in over 1,700 transactions.

You can find each transaction (and edit it if you want) by the date, the amount, the memo, who it was to or from, or the accounts it affects.

No knowledge of accounting is needed and no knowledge of computers is necessary. When each transaction is entered, the computer shows you the effect on your finances, and clearly prompts you for the next operation.

Requires 48K, 80-column printer (or wider) and two disk drives.

Price: \$49.95 Diskette

**LOAN ANALYSIS**

(Atari only)

In today's marketplace with sky-high interest rates and several different lending facilities to choose from, it is important to have at your disposal every scrap of information possible in order to make the most intelligent decisions about borrowing. This program is written to aid you in making the best possible choice when it comes time to borrow and to arm you with the facts about interest rates, payment schedules, and amortization of loans. This program will provide you with those options before you sit down with your lending facility.

The program is divided into three parts. Each part is available by making a choice from the menu. The first part allows you to vary the amount of the loan, interest rates, and the life of the loan. The second part gives you the option of determining how much you might save if you pay a little on your loan each month. It will show you the differences in interest paid, amount of total payments, and equity created. The third part will amortize your loan and show you month-by-month how your repayment schedule works and why the cost of borrowing money is as great as it is. LOAN ANALYSIS is a small investment which can save you much.

Requires 16K (cassette), 24K (diskette).

Price: \$17.95 cassette  
\$21.95 diskette

**THE FAMILY BUDGET**

(available for TRS-80, Apple and Atari only)

Welcome to the age of electronic record keeping. The Family Budget Program is designed as a two-part electronic home data record-keeping program. Part One, Budget, is used to record expenditures, both cash and credit, and income on a daily basis for the period of one calendar year. Three categories are used to record tax deductible items, namely Interest and Taxes, Medical expenses, and Charitable Donations. Part Two, Charge Accounts, provides a continuous record of all credit transactions. Each program provides options for hardcopy printout of various data. These printout options assume a printer is connected to Port #1 of the Apple.

As you receive it, FAMILY BUDGET is provided with 28 transaction categories:

- |               |                       |               |
|---------------|-----------------------|---------------|
| 1. Payments   | 11. Insurance         | 21. B & B     |
| 2. Savings    | 12. Gifts             | 22. Cash      |
| 3. Food       | 13. Interest          | 23. Charges   |
| 4. Meals      | 14. Medical           | 24. Pay       |
| 5. Rent       | 15. Charity           | 25. Add. Inc. |
| 6. Clothes    | 16. Labor             | 26. Fed. Tax  |
| 7. Utilities  | 17. Amusement         | 27. State Tax |
| 8. Laundry    | 18. Auto              | 28. Soc. Sec. |
| 9. Travel     | 19. Cigarettes (Ught) |               |
| 10. Education | 20. Home Furr.        |               |

Note: The Atari version has 20 categories.

You may easily enter, edit, save and recall data, print out selected categories according to transaction period, and much more. FAMILY BUDGET comes with an excellent 17 page instruction manual. Be prepared for that IRS audit!

Requires 16K program memory (Atari version requires 24K).

Price: \$34.95 Diskette

**BUDGET MODEL ANALYZER**

(Atari and Commodore 64 only)

BUDGET MODEL ANALYZER (BMA) is a unique financial-planning tool designed to provide you with a clear and revealing picture of your overall cash flow situation. It is easy to use and does not require cumbersome record keeping, yet it can show you a great deal about your spending habits and spending capacity.

To use BMA you need only provide a list of all your various incomes and expenses. Each income and expense must be described as being per day, work day, week, 2 weeks, month, quarter, or year. BMA uses these period specifications to correctly weight each income expense. BMA provides you with a very convenient maintenance system for creating, saving, and altering your list (or lists).

BMA can then expand your list into a complete matrix that shows each item in your list, expressed in each of the various period specifications (day, work day, week, etc.). It shows you the result of all your incomes and expenses.

For those who do not fully appreciate numbers, BMA will produce a bar graph giving a graphic representation of your budget.

BMA allows you to compare expenses occurring in varying frequencies. Is your \$5.00/work day lunch really worth \$109/month when you consider what that amount could do for you if you applied it to a house or car payment?

Even more useful is the ability to see clearly the result of all your incomes and expenses. How much extra spending capacity do you have?

Cassette version requires 32K; diskette requires 48K.

Price: \$29.95 Cassette  
\$33.95 Diskette

## PERSONAL FINANCE

### THE HOMEOWNER (IBM only)

THE HOMEOWNER can help owners of single homes (who do repairs and renovations themselves) and owners of rental property (who do repairs and maintenance on a regular basis to several properties) save money and be better organized.

THE HOMEOWNER is menu-driven, which makes it very easy to use. You need only select options from menus and enter data when prompted. There are no command sequences to learn. Very little knowledge of computers is required to use THE HOMEOWNER, and there are even tutorials.

THE HOMEOWNER provides several powerful and cost-saving functions:

- A data manager which helps you maintain accurate records of repair and renovation costs. It automatically computes sales tax and total cost (including labor) for a project and summarizes cost figures for projects. This part of the program is especially helpful at tax time. It is also a good way to keep track of fix-up costs if you are preparing a property for sale.
- A report generator which permits you to list or print both materials lists and project summaries. A unique feature of THE HOMEOWNER is the provision for printing a quotation form. This form allows you to enter and print required materials and descriptive information for use in obtaining quotes from suppliers or contractors. The quotation form also makes a shopping list.
- A materials estimator which helps you estimate required quantities of many repair and renovation materials. (No need to search for that high school math book to find the formula for cubic yards). This part of THE HOMEOWNER also provides you with required quantities of items needed to install or attach the material.
- An energy-saving estimator which projects energy savings from many improvements (heating day/cooling hour tables included). This part of the program also figures the playback period for energy-saving improvements. Includes energy calculations for storm window, caulking, insulation, etc., R-value heat loss calculations.

Includes a 120-page reference manual and a tutorial that will help you become familiar with all the parts of THE HOMEOWNER.

THE HOMEOWNER requires an IBM-PC or PCjr (or compatible), 128K of RAM and one 160KB diskette drive. Will run on 40-column or 80-column displays.

Price: \$59.95 Diskette

### THE LOAN ARRANGER (Atari only)

THE LOAN ARRANGER is designed to help you keep track of up to 25 personal loans, such as a home mortgage, automobile, education, home improvement, and so on. The program will allow you to monitor the remaining balance of each loan, the number of payments left, and the date of the final payment. You can see and print reports on the current status of all your obligations, and on your year-to-date payments for each. You can also print complete or partial amortization tables for each of your loans. Another feature allows you to combine various terms (principal, interest rates and number of payments) to compare monthly payments and the total interest paid. THE LOAN ARRANGER can be very helpful for short- and long-term budget and tax planning (and is tax deductible!)

Requires 40K, 80 column printer, Atari 810 disk drive.

Price: \$19.95 Diskette

### SHOPPING LIST (Atari, C-64, TRS-80 and IBM only)

With this program you can carefully plan your next trip to the supermarket day by day in advance. Each day you may enter the item to be purchased and its approximate price. When you are ready to go, SHOPPING LIST will print out an itemized list and the amount of money you need to take.

Requires 32K.

Price: \$16.95 Diskette

## PERSONAL FINANCE

### PERSONAL FINANCE MANAGER (Apple, CP/M, and IBM only)

PERSONAL FINANCE MANAGER (PFM) is designed to run under Microsoft BASIC (Release 5.2 or higher for CP/M; Applesoft BASIC for Apple) using any CP/M operating system. PFM includes all of the features of DYNACOMP's popular PERSONAL FINANCE SYSTEM, and has several more for those individuals with more complicated and extensive financial records.

PFM requires one or two disk drives and can store approximately 3,600 records on a single double-density 5 1/4" diskette. Up to four savings accounts and four checking accounts can be simultaneously maintained, with the balance in each account automatically displayed when in the menu mode. There is also a "cash" account.

All transactions may be flagged for later sorting. The three standard codes are taxable/non-taxable, checking/savings/cash, and deposit/withdrawal. There are also 26 user-defined codes.

Each of the checking accounts can be balanced separately. PFM sorts through the chosen account to find entries that had not cleared the bank at the time of the previous balance, and then asks if they have now cleared. The record of any transaction that has not cleared can be dumped to a printer if desired. The balance routine also has an edit feature to allow for direct editing while balancing the account.

A separate edit routine also exists to allow the user to edit any records that are in the data file. An individual account can be keyed or all records can be viewed starting with the most recent, scanning forward or backward as desired. As an added convenience, it is possible to jump to a specific record number if desired.

A sort routine has been included to allow the user to sort for specific records by selecting among six sort parameters. This can be done in several different ways. After the sort has been completed, a list of all the records can be printed, along with a summary including a graphic display for the year.

The sorting/searching/merging available in PFM is very flexible. For example, you may sort alphabetically, or by check number, category, etc. When searching, you may use "and" or "or" tests between categories (for example, collect entries corresponding to checking account #1 AND which are taxable OR which are written to a particular person). You have to use this capability to really appreciate its power!

PERSONAL FINANCE MANAGER requires one disk drive and a machine having at least 48K. A printer (80 columns or wider) is supported, but not required.

Price: \$49.95 Diskette  
\$52.45 Disk

## PERSONAL FINANCE

### PERSONAL FINANCE SYSTEM (available for all computers)

PFS was demonstrated on CBS network TV!

The PERSONAL FINANCE SYSTEM (PFS) offers the user one of the most complete financial management packages available, allowing the individual or small businessman complete flexibility in maintaining all aspects of financial record-keeping. Depending on configuration, you will be able to store from 300 to 2,000 transactions on each disk.

Records are easily entered into the master file and can be accessed by payee or by a user defined code (you may assign up to 26 different categories). PFS will keep track of all tax deductible items, bank deposits, monthly charges, cash payments, etc. It will even automatically deduct any check fees if desired. You will be able to get financial summaries for any category on a per item, monthly, or yearly basis. PFS will print the results in detail or summary form, access the printer if you have one, and even plot the results on a monthly bar graph!

PFS is available on diskette only. The Atari version includes DOS 2.0 on the diskette and utilizes that computer's sound, color, and graphics capabilities. The Atari version requires only 24K to operate; the North Star and other versions only 32K! Comes with an 11-page manual.

DYNACOMP is certain that you will find PFS to be one of your most valuable programs.

Requires 24K.

Price: \$39.95 Diskette  
\$42.45 8" CP/M Disk

### PERSONAL BALANCE SHEET (CP/M and IBM only)

PERSONAL BALANCE SHEET provides an easy way for you to create a statement of your financial position. Besides calculating your total assets (cash, accounts receivable, stocks, bonds, real property, etc.) and liabilities, PBS includes debt/worth, current, and acid test ratios. You can use PBS to forecast changes in your net worth based on changes in your investments and liabilities.

PBS is a well-designed, easy-to-use software package. It comes with a documentation package which offers step by step instructions, a sample data file, program notes and an annotated program listing (in BASIC). PBS outputs data to your normal (LPRINT) printer port. Requires an 80 column printer for detailed balance sheet output.

Price: \$29.95 Diskette

### THE CREDIT RATING BOOSTER (TRS-80 and IBM only)

The next time you shop around for the best possible interest rates on a mortgage, an auto loan or any other type of credit, use THE CREDIT RATING BOOSTER to help stack the odds well in your favor.

Most credit applicants do not realize that there are several factors which can reduce their credit-worthiness rating even if they know themselves to be 100% credit-worthy. Some of these factors are very simple and you should be aware of them in order to present an application which is as favorable as possible. These factors can mean the difference between getting low-priced credit at the most

## PERSONAL FINANCE

### COMTAX TAX PREPARATION (Commodore 64 only)

COMTAX is a full-featured tax preparation program for the Commodore 64 computer. Any person with a reasonable amount of experience in preparing his or her own taxes can use COMTAX with ease. The program asks the user for the necessary data, then compiles forms 1040, 2441, and schedules A, B, C, D, E, G, and W. Inputs are provided for all schedules not done by COMTAX.

COMTAX prints all forms that it compiles (if the user has a printer that uses the C-64's serial printer port). Otherwise data can be copied from the screen. The program has extensive error trapping built in as well as the ability to try itemizing and income averaging to see if you can save money with those schedules.

Modestly priced annual updates are available so that your COMTAX program will continue to be useful even if the tax laws should change. Also, COMTAX is tax deductible!

Price: \$39.95 Diskette

### HOME INSURANCE PROTECTOR (IBM and TRS-80 only)

There are six main reasons why people settle for too little on their home contents insurance claims. It is not unusual for someone to sign an agreement to receive settlement of a claim for \$5,000, only to realize weeks later that they should really have asked for \$7,000 in order to fully pay for the cost of replacing their lost or damaged items. HOME INSURANCE PROTECTOR safeguards you against the six common pitfalls that can lead to such an unfortunate situation.

HOME INSURANCE PROTECTOR keeps an up to date, easy to maintain inventory of your personal possessions. You can upgrade the value of the entire inventory to reflect inflation, or quickly adjust the values of single items. You can "page" through your inventory examining 11 items per full screen, display dollar totals and print an insurance company report or an owner's full report for safe storage.

HOME INSURANCE PROTECTOR is one of the most user-friendly programs available today. It has extensive error-trapping, full screen menus, multi-data file capability, an on-line "Help" screen, and it prompts you for important evaluation information where necessary. Requires 32K. Printer optional.

Price: \$19.95 Diskette

conservative institution in town or being forced to pay higher interest rates elsewhere.

THE CREDIT RATING BOOSTER was designed and written by a data processing consultant to major U.S. banks. It provides a well organized printout, or full screen displays of your up-to-date credit history in a way that is designed to suitably impress a loan officer.

THE CREDIT RATING BOOSTER is very user-friendly and easy to use. Before you apply for your next loan, be sure to have THE CREDIT RATING BOOSTER working for you.

Price: \$19.95 Cassette  
\$23.95 Diskette

**PERSONAL FINANCE PLANNER**

(Apple only)

PFP is a very powerful but easy-to-use financial management tool. Developed by an MBA/CPA, it prepares personal balance sheets, income statements, and detailed financial analyses. Insurance, real estate, stocks, bonds, mutual funds, and IRA analyses and projections are provided. PFP facilitates the performance of complex "what-if" projections to depict the long-term effects of changes in saving and spending patterns. It helps pinpoint problem areas and opportunities. Projections can be made to retirement or for any other period desired.

PFP is well documented, although extensive use of on-screen prompts enables you to get to work immediately. PERSONAL FINANCE PLANNER is not a home budget program; it is a versatile management tool that brings high technology computerized management into the home.

PFP requires 48K, and one disk drive. An 80-column printer is suggested, but optional.

Price: \$29.95 Diskette

**PC SECRETARY**

(IBM only)

PC-SECRETARY is an economical and powerful correspondence system containing a built-in text editor. Features include:

- **LETTER WRITING:** The built-in text editor allows you to create, edit, and otherwise manipulate up to 20 letters. You may automatically send your letters to any person, selected groups, or all on your mailing list. Even when printing hundreds of form letters in a batch, each letter can be individually addressed and that person's name used in the salutation and elsewhere in the letter.

- **ENVELOPE or LABEL ADDRESSING:** You may automatically address either envelopes or mailing labels.

- **AUTO DIALING:** (Available with a 300-baud Hayes-compatible modem) Just press a key on your keyboard and PC-SECRETARY will dial the number for you. You will hear the dialing, the phone ringing, and the other phone being answered. When answered, pick up your phone to start your end of the conversation and press any key on the computer keyboard. PC-SECRETARY will then become a notepad for your use while on the phone.

PC-SECRETARY is ideal for use with:

- **Business Mailing Lists:** Any list of prospects, customers, suppliers, etc., with whom you frequently correspond or plan to send at least one individualized "form" letter.

- **Club Membership Lists:** A phone directory with auto-dialing, a label printer for the newsletter, or a letter writer for dues and meeting reminders.

- **Christmas Card Lists:** Easy to update, automatically address envelopes, labels, even send personalized Christmas letters.

- **Personal Correspondence Directory:** Keep names and addresses of your friends and associates for easy letter writing, autodialing, etc.

You may store an unlimited number of name-and-address records, with up to 1450 per disk. Sorts both alphabetically by name, or by zip code.

Requires 128K, DOS 2.0, two disk drives (or one hard disk), a printer, and a Hayes-compatible MODEM (if autodialing is desired).

Price: \$49.95 Two Diskettes

**REFERENCE**

(CP/M only)

Scientists, engineers, graduate students, doctors, lawyers, and other professionals who need to document their nonfiction will appreciate the time-saving features of REFERENCE. This program combines universal data search and retrieval, note taking, and reference style conversion in one package. For each citation, all you do is enter author, date, title, publisher, volume, page, information, and as many notes as you wish—REFERENCE does the rest. With a few keystrokes your personal bibliographic collection is converted to any of the seemingly hundreds of reference styles that publishers demand.

REFERENCE allows you to search by first and last names of senior and junior authors, date of publication, and up to 5 keywords in the title, publisher's name, place of publication, and every note or quote in all references. The results of successful searches are displayed, printed, or stored on diskette for minor editing and inclusion with your manuscripts. You can enter data sequentially as prompted by REFERENCE or you can use a word processor to enter references alphabetically and to keep files up to date.

Over 1,000 references can be stored on one 180K diskette. And when your master reference and note collection grows larger, REFERENCE automatically sorts up to 25 additional diskettes in any one search.

These common reference styles are available at the stroke of a key:

1. University of Chicago Press (Sciences)
2. University of Chicago Press (Humanities)
3. McGraw-Hill
4. Harper & Row
5. U.S. Government
6. Clays and Clay Minerals
7. *Scientific American*
8. *Science*
9. Almost any other style which you can specify by preparing a punctuation list that is saved on diskette for future use.

Requires MBASIC, 64K, one or two disk drives, and a printer.

Price: \$99.95 Diskette

**BABY FILE**

(Apple only)

BABY FILE provides a permanent record of a child's accomplishments and vital statistics from birth through age 12. It is designed to accommodate any number of different children, and the records may be personalized in numerous ways. Included, too, is an opportunity to create a graph of each child's height and/or weight on each birthday.

BABY FILE was written with the novice user in mind. Once the diskette is in place and the computer is turned on, all necessary instructions appear on the screen. It is menu-driven and interactive. Various prompts on the screen allow the user to change information before it is permanently stored.

Although the graphs are done in color, a color monitor is not necessary.

Although you could write all of this information on index cards and plot the graphs on paper, BABY FILE is more fun. Also, it is a great gift for the expectant mother (or father)!

Price: \$19.95 Diskette

**FILES**

(IBM only)

FILES provides all the integrated software tools the typical professional, manager, or entrepreneur needs to work quickly and efficiently. The program features the following:

**It's a DATABASE MANAGER**

You can create, edit, save, retrieve, and perform data-management operations on relational data-base files. The basic storage unit is a file with similar files stored together.

**It's a SPREADSHEET**

Any data-base file can be treated as a spreadsheet. Values are referred to by using friendly names such as EARNINGS PER SHARE. Spreadsheet and database features are united in a common language. You can define the formulae, relationships, and equations in one file while the data used is located in another file. You can edit either file, then recalculate the spread sheet at any time with a single command. To permit complex or iterative programming, you can automatically record and repeat any command sequence (a very nice feature!).

**It's a WORD PROCESSOR**

FILES lets you create word processing files. You can insert, delete, revise, center, indent, move to or from a buffer, relocate, highlight for bold or underline printing, mark page starts, find, replace, scroll up, scroll down, page up, page down, etc. Features such as word wrap, right justification, margin, width, page length, and spacing are also supported.

Data files and word-processing files can be converted from one format to the other. You can also treat lines of word processing documents as spreadsheet entries.

**It's a CALCULATOR**

Standard financial computations such as present value, future value, annuity, loan, and depreciation are supported.

**It's a REPORT GENERATOR**

FILES will automatically generate a letter-quality report with headers and page numbers for either data files or word-processing files. You have the option of printing data files from top to bottom or from left to right. Details such as page and document totals are computed automatically.

Rather than having to write a procedure to display your data, it is always shown in a format based on the current settings of the format parameters (such as margin).

**It's a GRAPHICS GENERATOR**

You can view the data as records in rows or columns simply by changing the display mode. You may also see your data in stacked or separated bar charts. The cursor keys permit you to scroll through the graphs one at a time or from left to right. It's exactly like scrolling around in a large spreadsheet except the entire display is graphical. Other modes permit normal, composite, percentage, composite percentage, or log plots. The bars are automatically labelled and scaled. Text mode graphic characters permit operation with any display or printer. Special commands permit placing graphs within data-base files.

**It provides TRENDING**

You may compute the regression line relating several columns of data using any of 5 standard equation types. The resultant equation (or any user-defined equation) can be used to calculate an expected-value field. You can also compute the correlation coefficient, standard error of the estimate, multiple correlation coefficients, exponentially smooth data, moving averages, or interpolate between two values.

**It provides STATISTICS**

Using the statistics menu, you can perform most of the standard statistical tests of hypotheses, analysis of variance, or you can look up statistical distribution values.

**It's a CRITICAL-PATH MODEL GENERATOR**

You may determine a schedule of early-start, late-start, early-finish, and late-finish dates along with float, given a task list with duration, beginning, and ending-node data. You can also add a time plot to see the schedule.

**In addition —**

You can edit BASIC programs or assembly-language source code using the word processor. You can transfer ASCII files in or out. You can convert from almost any units to any other units. You can display the sum, average, etc., of the entire file. You can store multiple files in memory and manipulate them just as you would data in a calculator.

**But most of all, IT'S INTEGRATED**

All files of all types fit together in a common master list of relations. Once you set the margin, spacing, or any format value, the value acts in the logical way on graphs and data-file displays.

**And, IT'S EASY TO USE**

In addition to the HELP menus, there is a good User's Manual and a tutorial for beginners. The current file and command menu are always displayed and you can scroll or page in any direction to the desired position in any file in the data base. Instead of an unwieldy spreadsheet, the data is organized in logical packets or files, with all files integrated into the database.

FILES requires an IBM PC or XT with 256K (or more) of RAM, 2 disk drives (or a hard disk), DOS 2.0 or newer, and either a color or monochrome monitor. A printer is supported.

Price: \$149.95 Two Diskettes

**DATA RETRIEVAL SYSTEM (DRS)**

(CP/M, Commodore 64, and Atari only)

DATA RETRIEVAL SYSTEM (DRS) is a fast cross-indexing system which may be used to store and retrieve information according to key words. Although DRS was originally set up to index journal articles, it can be used equally well to cross-index record collections, recipe files, etc.

In the CP/M version you can conditionally search (e.g., BYTE, 1984, CRYPTOGRAPHY) by up to 4 key words. You can assign your conditional key-word search to any combination of fields (columns). The result of your search can be sent to the printer or screen. Also, you may include numeric data fields and conditionally sum them (e.g., a mini-expense system). In addition, you can establish an ALERT flagging system which prints a message when certain conditions are met (e.g., you have made more than three payments to a particular person in 1984). The CP/M version of DRS is more than a system to index journal articles; it is a versatile and flexible data management system.

The Atari version is set up more as a traditional indexing system. You can search on key words in the title (key words can be appended to the title). However, the length of the article description is unlimited.

Both the CP/M (MBASIC release 5.2 or higher; BASIC-80) and Atari versions are user-friendly and come with complete manuals. The Atari version requires 32K. The CP/M version requires 48K. Both require at least one disk drive. A printer is optional.

Price \$29.95 Diskette (Atari & C-64 versions)  
\$39.95 Diskette (CP/M version)  
\$42.45 8-inch CP/M Disk

## DATABASE MANAGEMENT

### DATA\*AID

(Atari only)

With DATA\*AID you store, organize, reorganize and retrieve information of your choice in a form which is useful and meaningful to you. All this is accomplished without using "computerese-type" prompts; you do not need to know programming to use DATA\*AID. All you need is a collection of data (information) on a given subject you wish to store and recall. Use it for:

- Household goods inventory
- Stereo tapes or records catalog
- Bowling scores
- Stamp or coin collections
- Little League statistics
- Recipe locator
- Address book
- Birthdays/anniversary book
- Expense records
- Gift list (size, style, color preferences)
- Anything you want

Comes on two diskettes. Requires 48K, one disk drive. Printer optional.

Price: \$39.95 (two Diskettes)

### FM PLUS FILE MANAGER

(C-64 only)

FM PLUS (File Manager Plus) is a powerful, yet easy-to-use data management program for storing, retrieving, and printing information. It can handle anything from a simple list of telephone numbers to an inventory system for a business.

Features include:

- Record size up to 1,000 characters for up to 50 fields.
- Up to 1,000 records per file.
- You design your files with alphanumeric, numeric, logical (Y/N), date, and calculated result fields (spread-sheet features).
- On-screen update of calculated files.
- Files can be redefined or modified at any time without re-entering any data.
- Both uppercase and lowercase are allowed.
- Key records on any field or fields for fast retrieval.
- Select records by record number, key, or search the file sequentially, matching on any criteria (including wild cards).
- Display selections or generate printed reports.
- You design your reports to print from any combination of fields in your file, sorted on any (up to three) field(s), with totals if you desire.
- Reports can be stored, reused, or modified without redefining the report.
- Print options include normal or compressed print, page numbers, multiple copies, line spacing, page width, and page length.
- Reports can be printed to the screen.
- Links to most popular word processing programs for mailings, labels, quotations, tables, etc.
- Options for formatting your data disk, displaying the disk directory, printing any screen to your printer, and a "dup key" to duplicate any field from the previous record.
- Can be used with 1 or 2 disk drives.
- Easy-to-understand menus with on-screen help.
- No complex commands or codes to remember.
- Complete with sample files and reports for several home/personal applications.

FM PLUS features a special status area for communications with you. If you press the wrong key, a message will inform you of that also. You'll never wonder what's happening while running FM PLUS.

FM PLUS is perfect for storing names and addresses, your household inventory, recipes, important dates, gift

## DATABASE MANAGEMENT

### DYNABASE DATABASE PROGRAM

(TRS-80, CP/M, and IBM only)

The DYNABASE DATABASE PROGRAM (DDP) is an easy-to-use database package which may be configured by the user. The program utilizes sequential access techniques to eliminate the requirements of setting limits on the size of any field, and to make the most efficient use of available disk space. The program functions have been structured around the file access method to provide the least amount of delay.

In operation, file size is limited only by available disk space, and there are no artificial restrictions on the length of text the user may enter into any field of a record. DDP may be configured to contain up to 10 text fields plus up to 10 numeric fields. Each field is labelled by the user.

A wide range of options is provided for printing out the database during the print, sort, search, and evaluation operations. Eleven "canned" printout formats are provided, along with a custom printout set-up option. The custom printout function allows the user to set up a customized printout format utilizing up to 255 columns. The set-up procedure also supports control code sequences to select printer density, font, etc. Once established a printout configuration may be saved to disk for future use as a printout configuration source. Printout routines include page control, page numbering, dating, source file name, and user heading.

The sort command allows the user to sort the data file according to any text or numeric field. The sort may be written to a target file, or may be used for print out.

The search command provides a wide variety of options for searching the data file. Results of the search may be sent to a target file, or the search may be printed out. The user can set up the "match" conditions (3 text, 2 numeric), or may select a range search. Any number of fields may be selected for searching, and up to 10 keywords may be entered for matching. Both the text and numeric fields are searchable.

A file evaluation command provides a math capability for the numeric fields of a file. Addition, subtraction, multiplication, and division are supported. (Beginning to sound like Visicalc?) The user may operate on and store the results in any of the numeric fields of the file. A constant may be substituted for one of the operands, and an option to totalize all the resultants of the file is also provided. The standard add, subtract, multiply, and divide functions are provided, along with the trigonometric, logarithmic and exponential operators. DDP also permits bar graphs to be printed, as well as mailing labels (e.g., 1-up).

DDP is user-friendly. All input data is requested by name, and data verification is required before the data is written to disk. The program is written to reject out-of-range or nonsense inputs, and error-trapping is provided to prevent data loss due to system errors. Easy to use editing features are also provided.

Price: \$49.95 Diskette

lists, checkbook information, every kind of record.

FM PLUS comes with a 54-page manual which was carefully designed to walk you through specific applications and answer questions which may arise. The goal is simplicity and ease of use!

Price: \$49.95

## DATABASE MANAGEMENT

### DYNAMASTER DATABASE™

(IBM only)

DYNAMASTER DATABASE is a general purpose program which allows you to easily create custom screen formats and enter data via the newly created screen, all within a few minutes. The screen design process is very simple. A variety of commands are provided to satisfy even the most experienced user while also being forgiving to the novice user.

Up to 99 fields can be specified. The records' length can be up to 1771 characters. The number of data records is only limited by the disk capacity.

Data entry is easy. Most commands are one character long and are always shown on the screen. You never have to remember any commands. DYNAMASTER is fully menu-driven.

Report generation is designed to allow even a user without prior experience to define and print a report quickly. All necessary information you need to make a decision is shown on the screen.

You can print mailing labels, filing cards, invoices, and statements on either blank or printed forms, with the data fields extracted from the data file. You can select all records or only selected records, and print the forms in any sequence.

DYNAMASTER has a unique formula calculation feature which allows you to manipulate data. You can do a number of trials on the record until a satisfactory result is found. This is a very useful forecasting tool. Here there is a resemblance to spreadsheet-like programs, but with a refreshing twist.

DYNAMASTER comes complete with a professionally prepared manual which is easy to understand and to follow along with the program. A sample data disk is also provided, which contains several popular prepared screen formats such as Name-and-Address List, Invoices, and Customer-Information List. The manual contains examples using the data in the Name-and-Address file on the sample data disk.

Requirements: 64K RAM, two or more drives.

A printer is supported (80-132 columns).

#### Features

#### SCREEN DESIGN

- Free-form screen design: add, insert, delete, copy lines
- Up to 99 fields per screen
- Display or print screen and data-field attributes
- Show disk files and allow user to delete any file without ending program.

#### DATA MANIPULATION

- Add, delete, update, print, copy, select, and display records using the same screen. No jumping from menu to menu.
- Show prompts in normal or reverse image.
- Show data in normal or reverse image.
- Each record has a unique key for extremely fast random access to it.
- Reorganize data file. Recover data file after disk error.
- Copy files to any disk for back-up purposes.
- Copy or merge or append data from another file selectively, based on field names used in the two files. Copy only selected records.
- Define formula for what-if type of calculations.
- Do table-lookups from up to 22 different files simultaneously and extract up to 9 data fields from each file.

#### REPORTS

- Design custom reports. Include any data fields in any order.

## DATABASE MANAGEMENT

- Reports automatically dated and page numbered
- Print sub-totals and grand total for up to 25 columns.
- Sort the report in any sequence. Up to 5 sort fields allowed. You can even sort on a field which does not appear on the report.

#### PRINT FORMS

- Define specification to print custom mailing labels, invoices, purchase orders, customer statements, file cards, or just about any printed form.

#### CONVERT FILES

- Program can convert dBASE II files automatically into local format and vice versa.
- Convert local files to ASCII format.

#### MEMO WRITER

- Program has a unique feature called Memo Writer. It allows you to write short memos and letters very fast. Very few commands are required.
- You can assemble new memos from data extracted from existing memos. You can exclude/include any line or a group of lines from any memo stored in the memo file.
- Store up to 999 memos in the file.

#### OTHER FEATURES

- Program is completely menu-driven. All options are shown clearly. Very little to memorize. The keyboard function keys are carefully selected and designed into the program to fit the human hand.
- You can type ahead; commands are held in the keyboard buffer in anticipation. The commands are stored and executed in sequence.
- Program scans for disk errors, device not ready, disk full, file not found, and numerous other situations. Easy recovery is provided.

#### REVIEW COMMENTS

From PC Magazine, July, 1984

"Many programs costing two to three times as much can not do what [DYNAMASTER] can... you should be well rewarded."

"Encourages high speed data entry..."

"One of the most powerful features of [DYNAMASTER] is its ability to perform table lookups... This table lookup feature is extremely sophisticated..."

Since that review, DYNACOMP has acquired publishing rights and, following our low price policy, has halved the package price to \$99.95.

Price: \$99.95 Two diskettes plus 180-page manual \$14.95 Manual Only (can be applied towards purchase of complete product.)

#### FAMILY TREE

(Commodore 64 only)

FAMILY TREE is a specialized genealogy data base system for recording and analyzing family histories. It can accept, edit, and store data for 500 individuals and provide either screen or printer reports. Features include:

- Year search: display all members alive in that year. Can be limited to direct lineage.
- Name search: first, last, or both.
- Family search: display family statistics such as father's name, members, vital statistics.
- Alphabetical sort and list.
- Vital statistics: first and last name, birth date, birth place, date of death; father, mother, and spouse ID numbers.

For four-generation displays, an 80-column printer is required. Includes a 20-page manual.

Price: \$19.95 Diskette

**VINOBASE 2.0**  
(IBM only)

VINOBASE 2.0 is a database system designed for managing a personal wine cellar. It allows you to add, delete, and edit wine records, as well as to maintain a notebook of comments about each wine in your collection. It also enables you to search the database for particular types of wine, and provides a statistical analysis of the entire wine collection or a targeted subset of wines (e.g., the percentage from each region, etc.). Most important, VINOBASE 2.0 can be customized to meet the level of detail which you choose to describe your wine collection.

VINOBASE 2.0 allows you to maintain the following information about each wine in your cellar:

- Wine region.
- Wine subregion.
- Wine name.
- Vintage.
- Color.
- Price.
- Quantity.
- Type of wine.
- Quality rating.
- Retaste data (time to drink).
- Any additional notes you require.

With 128K of RAM you can store 100 records per database, or 200 with 256K. However, you can install as many databases as you wish (e.g., red wines from France, white wines from California, etc.). In other words, your database can be essentially unlimited.

A printer is supported. BASIC is not needed.

Price: \$39.95 Diskette

**HISCORE DATABASE**  
(Atari only)

HSD is designed to maintain the game score records for you and your friends. You may display, print (to a printer), update, sort (fast!) and generally maintain game scores. An excellent present for that avid game player! Requires 16K (cassette), 24K (diskette). A 40K disk system can store over 400 records.

Price: \$16.95 Diskette

Collection: STAMPS and COINS may be purchased for a combined price of \$149.95. Sorry, collections can not be further discounted in DYNACOMP's 10% - 20% quantity discounts.

**COINS**

(TRS-80, IBM and Apple only)

COINS is short for COverputerized Inventory of Numismatic Stock. It is written by Marvin C. Mallon, a noted columnist for *Coin World* magazine.

COINS enables the serious numismatist to catalog an entire collection and obtain several reports that serve for personal investment information.

The principal feature of COINS is its built-in standard coin file. Sixteen-hundred common U.S. coin descriptions, along with the latest market value for most grades, are included. This provides an automatic means for tracking the value of your collection. Annual update disks are available which allow you to stay up to date with the latest prices. The data file includes:

- All small cents since 1856
- All nickel five-cent pieces since 1883
- All dimes since 1892
- All quarters since 1892
- All half-dollars since 1839
- All dollars since 1878

**STAMPS**

(Apple, IBM, and TRS-80 only)

STAMPS lets you concentrate on the fun of philately by saving time on the "bookkeeping" work of inventorying and pricing your collection. It covers all U.S. stamps indexed by the Scott Catalogue Numbers. Virtually every issue listed in Scott's National Album is included. All in all, STAMPS is a powerful, yet easy-to-use tool to keep your collection current.

STAMPS also maintains a want list, complete with prices; the computer never forgets what stamps you want to purchase. When you add a new prize to your album, STAMPS records the date and price of purchase so you won't have to dig through receipts or trust your memory later. When you sell a stamp, the program even calculates your percentage profit.

There's also an electronic window into your collection that lets you look up the value of any item, pinpoint its location (at home or in your safe deposit box) — or take a look at your entire collection without moving from your computer.

As your investment grows, you can check its new value each year with a special update disk that's available for a minimal charge.

**Features:**

- Covers more than 2,500 U.S. postage stamp issues in nine different grades.
- Uses convenient Scott numbers and instantly shows current stamp values.
- Keeps you informed so you can sell right and buy right.
- Tracks the value of your investment, automatically updating prices each year.

**Reports include:**

- Value — Lists all stamps in collection, purchase price, current price, and profit or loss.
- Summary — Calculates the bottom line purchase prices, total value, total profit or loss.
- Stamps Sold — Gives details on cost and profit from stamps sold.

Each STAMPS package includes the program and the latest market value file for all U.S. postage stamps, all on one diskette. There's also a clear and complete 32-page instruction manual, owner registration form, and annual update request form.

Requires two drives. An 80-column (or wider) printer is required for printing out reports. The IBM version requires 256K of RAM.

Price: \$89.95 Diskette

Yearly updates to the catalog prices cost \$25.00 (one diskette).

Entering a coin is accomplished by referring to the coin's number from the standard coin list (included in the system). Not only the coin's description (mint, date, denomination, etc.), but its current value across most grades is immediately displayed. You designate the grade and the computer takes care of the rest. You may include what you paid for the coin, and from whom it was purchased. You may also alter the market value of any entry. U.S. coins (other than the initial 1,600) and proof sets and rolls may also be entered. A quantity column allows tracking of duplicate coins.

Included in the COINS package are the disk, a 48-page user's manual, and an annual update order form. Updates cost \$25 (plus shipping and handling).

Requirements: Apple (48K+), TRS-80 (48K+), or IBM (128K+). Also, two drives and an 80-column (or wider) printer.

Price: \$89.95 Complete system  
\$14.95 Preview pack

**COINDATA AND STAMPDATA**

(IBM only)

COINDATA (CDA) and STAMPDATA (SDA) are high-speed compiled BASIC (source included) programs which use random-access files to compactly store and quickly retrieve stamp and coin collection information. Both programs are easy to use, self-prompting, and well error-trapped.

With these programs you may record the various characteristics which describe your collections, search for coins and stamps having particular characteristics, compute totals (e.g., for tax purposes), and print in several formats. Up to 300 coin records can be cataloged on a single-sided disk (800 on a double-sided diskette). If you are using a dual-drive system, the collection size is unlimited; the program will prompt for new data diskettes in drive B as the need arises.

The characteristics included are:

COINDATA	STAMPDATA
File No. and Date entered	File No. and Date entered
Category & Denomination	Country
State or Sub-category	Category
Comments	Year
Mint Mark Location	Perforation
Design (Issue Description)	Watermark
Year and Mint	Printing Method
Quantity Minted	Scott Catalog No.
Variation	Scott Illustration
Condition	Comments
Date Acquired	Denomination
Quantity acquired	Color
Price	Condition
Date sold	Date purchased
Quantity sold	Quantity purchased
Dealer price	Price
	Date sold
	Quantity sold
	Price
	Dealer price

The print and search options include:

- Print a selected listing
- Print a range of listings
- Print a catalog investment status including results of trading. The financial results are summed for tax purposes as regular or capital gains income and include estimated market value.

**FLIGHT PLAN**

(CP/M only)

FLIGHT PLAN™ is an inexpensive general-aviation package which provides pilots, instructors, and fixed-base operators with:

- Flight-planning checklist for recording airport, communications, weather, and special-use airspace data and Notices to Airmen.
- Weight-and-balance computations for specific 2- and 4-place aircraft and typical rental aircraft.
- Navigation computations: magnetic course, magnetic heading, ground speed, leg time, and total distance and time for up to nine legs (unlike some programs, FLIGHT PLAN allows direct routing and does not depend on specific navigational facilities and their operational status).
- Kneeboard-size Flight Log showing checkpoint, distance, true air speed, altitude, magnetic course, magnetic heading, ground speed, leg time, and total distance and time, with space for noting compass error, actual time, navigational aids, and preflight and inflight recalculations.
- Fuel requirement and reserve computations, with provision for ground time and for diversion to an alternate destination.
- Reminders of loading and VFR and IFR altitude and

- Search/print entries according to a particular characteristic.

Price: \$39.95 COINDATA  
\$39.95 STAMPDATA  
\$69.95 Collection (both programs)

Note: Collections may not be included in the 10%/20% quantity discounts.

The above description was for the IBM version. The Apple version is very similar and combines both coin and stamp collecting. The price for the Apple version of COIN DATA/STAMP DATA is \$49.95 (diskette only). Requires 48K.

**MYCALC™**

(CP/M and IBM only)

MYCALC™ is an easy to use calculating tool which can compute your budget, record and project your investment returns, and even do your taxes. MYCALC™ provides all the important capabilities of a two-dimensional "What if?" calculator program, including: formulas, labels, variable column width, logical operations, references across multiple spreadsheets, sort, and print to line printer or disk file. Yet MYCALC™ is uniquely easy to use, and configurable to your terminal's function keys to provide a true full-screen editor "feel" for work-sheet manipulations. Simple keystroke commands allow operations on entire rows or columns to conveniently rearrange your data, or quickly build or revise templates and models. Display formats include scientific, financial, and bar graph. The PC/PCjr version can be used in either 40 or 80-column mode. The manual includes step-by-step "hands-on" tutorial making it easy to get started. The command line menu presents your options, and 23 on-line help screens keep you going. MYCALC comes with many useful templates, including a set to automatically compute your full IRS Form 1040 and itemized deduction Schedule A.

This program has been reviewed under its earlier-version name, ZenCalc, in *InfoWorld*, October 4, 1982, and in *Sextant*, in the Winter 1983 issue.

Requires 64K and an 80-column screen.

Price: \$59.95 Diskette  
\$62.45 8-inch CP/M Disk

fuel requirements.

- Flight-cost estimates.
- A plain-language guide to FLIGHT PLAN's proper use, with safety conditions paramount.

FLIGHT PLAN's author is one of the Federal Aviation Administration's appointed volunteer accident-prevention counselors, and the program and guide were written to facilitate compliance with Federal Aviation Regulations for flight planning.

The program is one of the very few aviation packages available for CP/M computers. At only \$59.95, FLIGHT PLAN is well under the prices charged by commercial flight-planning services.

Requires MBASIC Release 5.2 or newer (BASIC-80).

Price: \$59.95 Diskette  
\$62.45 8-inch CP/M Disk

**FOR THE BEST PRICES ON EXCELLENT QUALITY DISKETTES, SEE OUR SUPPLIES SECTION. WE DO NOT SELL THE REJECTS, SECONDS, OR REDUCED SPECIFICATION DISKETTES WHICH ARE NOW BEING SOLD AT "AMAZINGLY" LOW PRICES. THEY ARE NOT SO AMAZING IN QUALITY!**



## DATABASE MANAGEMENT

### HOME INSURANCE INVENTORY

(Commodore 64, CP/M, IBM, and TRS-80 only)

THE HOME INSURANCE INVENTORY is an easy-to-use inventory program which is specially designed for valuable collections and household inventory records. All program commands are in the form of menu selections; making program operation very easy. Additionally, all user data entries are prompted by name. Full editing capability is provided, as well as commands to search and sort the file. Two printout formats are provided, and output may be sent to the printer as well as the CRT screen. Additional commands provide for generating a total valuation of the file, and for automatic updating of the quantity and value of each entry, making record maintenance simple.



Price: \$29.95

The C-64 version uses the serial port for printing. The TRS-80 version requires one drive and 48K of RAM. The IBM and CP/M versions require two drives and 64K. The CP/M version requires MBASIC release 5.2 (BASIC-80) or higher.

### COLLECTOR'S PARADISE

(TRS-80, C-64, and IBM only)

Three collectors inventory programs in one:

- Coin collection
- Stamp collection
- Rare collectibles

Keeps a complete inventory of all of your valuable collections. Quickly adjusts the current value of items to keep your insurance and personal records up to date. You can add, delete or change items as you page through your inventory looking at 11 items per full screen.

COLLECTORS PARADISE is very user-friendly and easy to use. It provides you with the total dollar value and price paid for each collection, plus the percentage appreciation in value. Optional printed report gives full details of all items for safe storage, plus the total dollar value of your collections. Requires 32K. Printer optional.

Price: \$19.95 Diskette

### SPELL

(CP/M and IBM only)

SPELL is just the thing to check your documents for accurate spelling, and it's carefully crafted to fit your machine and your budget. SPELL detects misspelled words in documents created by most word processors, including PIE, WordStar, SpellBinder, and Magic Wand. SPELL's flexibility lets you simply list unknown words, mark them in your document for easy editing, or add them to your dictionary. Sophisticated algorithms and a prefix/suffix table compress an effective dictionary of over 50,000 words into fewer than 31K bytes of disk space, far fewer than other spelling programs occupy. SPELL has a fast in-memory lookup process: over 4,000 words per minute (4 MHz Z80). Detects 99.8% of the misspellings while minimizing false reports of correctly spelled words. You can add new words and prefix/suffixes, even customize for British spellings.

SPELL has been reviewed in *Interface Age* (August 1982), *Microcomputing* (July 1982), and *Portable Companion* (June 1983).

Written by Software Toolworks

Requires 48K of RAM.

Price: \$49.95 Diskette

\$52.45 8-inch CP/M Disk

## DATABASE MANAGEMENT

### DESKTOP BIBLIOGRAPHY

(TRS-80 only)

DESKTOP BIBLIOGRAPHY is designed to allow the user to easily and efficiently construct a bibliographic reference system. For example, engineers, managers, executives, professionals and similar people might use DESKTOP BIBLIOGRAPHY to create a reference file of magazine articles. Writers might use DESKTOP BIBLIOGRAPHY during the research phase of a book to create an index of their work by inserting entries for each page or section. The search and sort commands provide a variety of useful, flexible, fast and powerful methods of accessing this data. For example, keyword searches may be made by category or globally, and they are fast! Reference size is limited only by available disk space. Editing is very convenient.

This program is designed for a TRS-80 Model I or Model III disk system with either 32K or 48K of RAM. When run, the program will automatically configure itself to the available memory. A printer is supported.

Price: \$19.95 Diskette

### SOFTSTATS BASEBALL/SOFTBALL RECORDS

(Apple only)

SOFTSTATS allows you to maintain virtually every statistical record that an official scorer would keep for a professional game, or you may record only those statistics that you deem necessary. SOFTSTATS is menu driven and very "user friendly". Every screen has a message line with directions, suggestions, and hints to save you learning headaches. You will be a proficient user almost immediately.

SOFTSTATS stores statistical and personnel information for as many teams as you want. Complete records are stored for:

- Individual hitting.
- Individual pitching.
- Individual fielding.
- Team hitting.
- Team pitching.
- Team fielding.
- League or division standings.
- Individual game summary.

You may also display or print a team roster (with names, numbers, positions, bats, and throws), or a game lineup and score sheet for eight to ten players.

There are 21 batting, 18 pitching, 7 fielding, and many other team statistics stored. Batting averages, earned-run averages, winning percentages, slugging percentages, on-base percentages, fielding percentages, and other calculated statistics (such as total bases, times on base, plate appearances, and team statistics) are figured for you.

Various types of configurations are possible: 5, 7, 9 innings; 8, 9, 10 players; different configurations for each team; etc.

Requires 64K, Apple IIe or Apple IIc. A printer is supported and is recommended. Includes a clearly written 80-page manual.

Price: \$49.95 Three diskettes

## DATABASE MANAGEMENT

### MAIL LIST 4.0

(Apple only)

MAIL LIST 4.0 is an invaluable aid for the management of extensive lists of names and addresses. Options include alphabetical and ZIP Code sorting (over any length ZIP Code), file merging, additions and deletions, label printing (1-, 2-, or 3-up) and three different printout formats. MAIL LIST 4.0 will even find and delete duplicate entries!

One of MAIL LIST 4.0's most powerful features is a virtually unlimited key-word selection capability. Any number of three-letter user-defined key words may be employed for each entry. Entries can be selected by key word or unique combinations of key words, by name, or by ZIP Code or ZIP Code range! Once selected, entries can be written to the printer for producing address labels or a special on-line format can be employed for convenient record keeping. Selected entries can also be added to other data files making MAIL LIST 4.0 one of the most versatile programs of its kind regardless of cost.

MAIL LIST 4.0 can handle 500 names per disk. An 80-column (or wider) printer is required.

Price: \$34.95 Diskette

#### OPTIONS CODES:

START = START NEW FILE  
 A = ADD TO LIST  
 DF = DELETE WITH FLAG  
 DP = PURGE FLAGGED ENTRIES  
 DUP = DELETE DUPLICATES  
 N = NAME SEARCH  
 K = KEY-WORD SEARCH  
 R = REVIEW LIST  
 W = WRITE LABELS  
 M = MERGE LISTS  
 Z = ZIP CODE SORT  
 ABC = ALPHABETIZE  
 STEP = STEP THROUGH LIST  
 OUT = SELECT OUTPUT DEVICE  
 F = OPEN NEW FILE  
 (W) = WRITE SUFFIX  
 (L) = LIST SUFFIX  
 (F) = FILE SUFFIX

#### EXAMPLE:

ENTER OPTION: Z  
 ZIP CODE SORT (SO) OR SEARCH (SE)? SE  
 ENTER ZIP CODE RANGE, LOW TO HIGH.  
 LOWEST ZIP CODE? 14000  
 HIGHEST ZIP CODE? 15000  
 DEFEAT KEYWORD PRINTOUT? Y

### VIDEO CASSETTE DIRECTORY

(Osborne only)

VIDEO CASSETTE DIRECTORY (VCD) is a sequential data file system, consisting of a main program and six chained programs, which allows you to create, maintain, and examine up to 500 records (18 fields each) associated with a video cassette collection. If you are a video cassette recorder owner whose collection of recorded tapes has outgrown a manual inventory system, or if you are a fledgling programmer who would like to learn how to write data file programs in BASIC, this system is designed for you.

VCD is menu driven, includes numerous on-screen prompts, features CRT forms to facilitate data entry and editing (with unambiguous prompts on 1 or 2 status lines), checks input extensively for errors, and provides 12 formatted output options either to the monitor or the printer. Eleven of the output options incorporate

## DATABASE MANAGEMENT

### MAIL MASTER II

(IBM only)

MAIL MASTER II is a comprehensive mail list manager for name, address, and phone number storage and retrieval. It also provides a 250-character comment section for each entry and includes user-defined coded retrieval of records (in addition to alphabetic and zip-code retrieval). MAIL MASTER II does not require any disk or screen display programming and is therefore immediately usable. MAIL MASTER II is ideal for those desiring computerized mail list records, and many of its functions were designed with the idea of easily handling large lists.

Five lines are available for name and address, which allows for the inclusion of titles and company references. Since each can be individually edited, modifications are easy. The comment section functions much like a word processor; changes can be made without retyping the entire comment.

On-screen messages inform you of the current file name, its sort status, the date it was created or last sorted, and the current number of records. Additional messages remind you of the status of the displayed record. The use of on-screen messages makes it easy to learn the program and its capabilities.

The output can be either single-line or mailing-label format. You can use any label width or number of columns (1-, 2-, 3-, and 4-up). In addition, you may even send control codes to your printer from within the program to change the print characteristics, such as condensed mode or the number of lines per inch. In order to adjust paper alignment, the program will output test prints. This saves on much of the "trial and error" required by other mail-list programs.

MAIL MASTER II has been designed to offer you the maximum amount of flexibility while maintaining speed. You may merge files or split existing files, based on alphabetical range, zip codes, or user-defined codes. Individual files may be sorted into either alphabetical or zip-code order. MAIL MASTER II will use either an in-memory sort, if sufficient RAM is available, or a disk sort. In both cases, no intermediate file is generated; files may be sorted even when no additional disk space is available. This maximizes how much you can save on a disk. There is also a function to remove duplicate records from a file.

MAIL MASTER II can store 1,200 names on a single 320K disk. File size is limited only by available disk space (hard-disk compatible). In addition, the file structure is specified so that you have the structure information required to convert your data base files to MAIL MASTER II format. Requirements: 128K, at least one disk drive, and a printer. BASIC is not required.

Price: \$99.95 Diskette

one or more sorts: alphabetical by title, numerical by cassette number, or by one or all categories of programs, stars, directors, or studios.

Included with the program disk is an 87-page owner's manual. A 12-page user's guide section discusses each menu option, so there will be no surprises when you run the program for the first time. A 22-page tutorial, and 47 pages of associated appendices, details the "what, why, and how" of each of the programs. It includes numerous suggestions and instructions for modification of the programs. In addition to the formatted easy-to-read program listings, each of the programs is completely outlined (e.g., flowcharts, variable cross references, etc.), making the logic easy to follow. Careful study of these materials will lead to an understanding of how the system functions, how to modify it if you wish, and how to apply those principles while writing your own data file programs.

Price: \$49.95 Diskette

**THE MEMBER TENDER™**  
(IBM only)

THE MEMBER TENDER™ is an efficient and complete membership management package for organizations. It fills the gap between general data-base programs (which are difficult to learn and operate), and expensive customized programs written specifically for single organizations. It is menu driven so that an inexperienced user may operate it with a minimum of effort. Yet THE MEMBER TENDER™ may be customized to fit specific requirements as well. This is done by allowing you to define the way in which the system keeps track of membership. You may define the following:

- Category of Membership
- Membership in Sub-Groups
- Dues Tracking Categories
- Geographical Categories
- Dates of Membership
- Form Letter Production

In addition, THE MEMBER TENDER™ keeps track of contributions, membership in other organizations, and maintains a "privacy" function which inhibits the production of mailing labels for specific mailings.

Reports and labels may be produced to include any of the user-defined categories above in several different formats. Reports may be produced in alphabetical order or in order by category of membership. Mailing labels are produced in ZIP Code order. Statistics are also maintained based on membership categories as defined by the user. This valuable feature can add priceless information to aid in the management of any organization.

**Specifications:**

- Membership categories: Up to 12, up to 3 per member.
- Membership subgroups: Up to 24, up to 15 per member.
- Dues tracking: Up to 12; can be done according to numerical range (e.g., all those who paid \$10 to \$20, paid \$15.00 exactly, etc.)
- Geographical location: Up to 12, defined by ZIP Code ranges.
- Membership dates: Up to 24 categories (dues, subscription expiration, etc.)
- Privacy function: E.g., skip label printing for some members, etc.
- Form Letters: Up to 5, printed according to an above category (e.g., late dues, subscription running out, etc.)
- Statistics by Category
- File structure compatible with dBase II.

Capacity: Two 360K diskettes can hold 1,500 members. A hard disk can hold up to 65,355 members.

Includes a 100-page, step-by-step manual with examples, suggestions, and other helpful information.

Requires: DOS 2.0 or higher, 128K of RAM, and a printer. State whether you have MSDOS or PCDOS when ordering.

Price: \$79.95 Diskette

**HOW BIG IS  
DYNACOMP'S TECHNICAL  
TROUBLESHOOTING STAFF?**

SMALL! We get so few problem calls that we have only one person formally assigned to telephone technical support, and he spends most of his time doing other things while waiting for calls. Perhaps he and the local Maytag repairman should get together to commiserate.

**BOWLING LEAGUE  
RECORD SYSTEM**  
(IBM only)

The BOWLING LEAGUE RECORD SYSTEM is a set of programs designed to facilitate accurate record keeping of all individual and team bowling scores following the guidelines of the American Bowling Congress (ABC) and the Women's International Bowling Congress (WBIC). The system provides the following features:

- Scratch or handicap female, male, or mixed leagues are supported.
- Automatic archiving and updating of individual and team records and scoring statistics.
- Season-to-date league standing report containing individual and team average and scoring statistics.
- Scoring recap sheets based upon the league bowling schedule and season-to-date team lineup, bowler average and handicap statistics.
- Seasonal league bowler list containing season-to-date scoring statistics.
- Individual and team detailed archive reports.
- Editing and updating of individual and team records, initialization data, and the bowling league schedule.
- Summary report of individual and team statistics for the entire league.
- The Epson (MX80), C.Itoh (8510), and the Okidata (92) dot matrix printers (or compatibles) are internally supported.

One very nice feature is the integrated League Standing Sheet which shows:

- Team standings sorted in season-to-date points won/lost sequence including points won, points lost, games bowled, scratch and handicap total pinfall, average high game, and high series.
- Individual average listing for all league bowlers in team and bowling order showing season-to-date last series bowled, average, handicap, games bowled, total pinfall, high game, high series, number of 200 games, and number of 600 series bowled. Handicap data is automatically omitted for scratch leagues.
- League substitute bowler statistics are listed separately and contain the same season-to-date data as for the regular league bowlers.
- Separately sorted honor scores for team and bowler showing season-to-date scratch and handicap scores for league high games and series. Separate lists are provided for male and female bowlers in mixed leagues. Handicap data is automatically omitted for scratch leagues.
- Sorted season-to-date most-improved-bowler list showing bowler improvement over 21 games. separate list is provided for male and female bowlers in mixed leagues.
- Weekly bowler honor score listing of all league bowlers who bowled above-average games or series. User-controlled threshold for announcing game and series score.
- The next four weeks of the league bowling schedule by lane assignment and team.
- Optional league officers' message area.

The BOWLING LEAGUE RECORD SYSTEM is easy to use and contains many user-friendly features and prompts. The system of programs is menu driven with explicit instructions for option selection and input response. BLRS is a real time saver for the beleaguered bowling secretary. It will handle up to 25 bowling teams for up to a 40-week schedule. Also, the system supports up to 60 substitutes or replacements during the season.

BLRS requires DOS 1.1 or higher (BASIC not needed), two 320K (or larger) disk drives, 128K of RAM, and a printer (see above).

If you have a printer other than those described above, BLRS can be modified for your printer for an extra \$15.00.

Price: \$89.95 Diskette

**WORD FINDER 3.0**  
(IBM only)

Find the right word for your thought without taking your hands off the keyboard or your eyes off the screen. With WORD FINDER you just place your cursor on the word you want a substitute for, and up pops a window with a list of alternate words with similar meanings. Put the cursor on the word you want, and press the return key. The new word instantly replaces the old word right in the document, even retaining the exact punctuation and capitalization.

There are over 200,000 synonyms for over 15,000 key words. WORD FINDER has a contemporary vocabulary designed for writers and business users, not just literary scholars. Archaic meanings have been culled to make the word choice more precise and up-to-date. An average of ten synonyms is provided, but some words may display as many as sixty synonyms.

You can even use WORD FINDER for confirming both word meaning and spelling. (Such as whether to use *affect* or *effect*, or how many *l's* there are in "parallel".)

Because WORD FINDER is not copy protected, you can change word processors as often as you wish. It is compatible with WordStar, WordStar 2000, Multimate, Word Perfect, Pfs:Write, Microsoft Word, IBM Writing Assistant, Easy Writer II, Framework, Volkswriter Deluxe, OfficeWriter, and Palantir Word Processors. Word Finder works right along with other memory-resident programs, including Sidekick, Superkey, Smartkey, Prokey, and others.

Here are some of the reviewers' comments:

*It's quick, convenient, and reliable. All you could ask from a computer program. Its speed and ease of use make it the the tool of first choice.*

Henry Kisor  
Chicago Sun Times

*WORD FINDER is an affordable adjunct for whipping (flogging, thrashing) your prose into shape quickly and efficiently, without leaving the document file you're working in.*

David Obregon  
PC Magazine

The older (90,000 synonyms) version of WORD FINDER hit the top twenty in sales for SOFSEL within 30 days of its introduction, and was priced at \$79.95. DYNACOMP's version is better — and costs less!

Price: \$69.95 Two Diskettes

Requires 128K of RAM.

**GOLFER'S DATABASE**  
(Atari only)

If you play golf or plan to, GOLFER'S DATABASE is for you. Designed by an engineer with a two handicap, this very easy-to-use program (comes with a 20 page manual that's rarely needed) is designed to keep track of your golf scores, number of putts, greens hit, courses played, course ratings, course and weather conditions plus other important scoring statistics.

As a data base you will be able to add, edit, delete, search and sort your records as desired. A specialized data file is generated by the data base which is used to analyze various types of handicaps, stroke averages and scoring characteristics.

All members of your family and/or golf league can have separate data files, each of which can be reviewed and analyzed individually. If you have a printer, all data records and analyzed output can be printed. Included in the data base is a graphing program which will plot and graph all your scoring characteristics.

**DYNAWORD DOCUMENT CREATOR**  
(IBM only)

Judged by what it does, DYNAWORD can be classified as a "word processor". Judged by how it operates, "digital typewriter" might be a better descriptor.

DYNAWORD is the practical, ergonomic, and economic answer to the over-stuffed, hard-to-learn, hard-to-use, over-priced mammoths which dominate the market today.

In designing DYNAWORD, the undesirable features of the current word processors were examined: the fatigue associated with searching the screen for a flashing cursor, the over-use of operator intervention to activate every function, and the lack of correspondence between the screen display and the printed document.

DYNAWORD has replaced the flashing cursor with a highly visible "carriage" which always occupies the same screen line; the document scrolls. Editing response is fast and consistent. Also, most format operations can be pre-set and performed automatically: right justification, dehyphenation for editing, proportional spacing, etc., all with a minimum of fuss. Also, DYNAWORD displays the text on the screen as it will appear on the printed document. As you type, the justification takes place before your eyes!

An interesting extension of DYNAWORD is its ability to manage and display word or screen page based alphabetical files. These files can serve as a spelling checker, a thesaurus, or a general or specialized dictionary. These files can also be created with DYNAWORD. The process is fully described in the 94-page DYNAWORD user's manual.

The active screen display shows the number of pages saved in memory, a reminder of the available sub-commands in the current mode, as well as the text. Help screens are also available.

Text file management is very efficient compared with the currently popular word processors. With a 128K machine, 54 manuscript pages can be stored in active memory (RAM). With a 360K single-drive system, up to 230 manuscript pages can be saved (PCjr owners note: you do not need to buy a second drive to use DYNAWORD). Any consecutive text page is displayed in 0.22 seconds; any previous page in 0.68 seconds. This is more than 30 times faster than two of the most popular word processors on the market.

Text can be scrolled forward or reverse one line or screen page at a time. Pages can be called up by number. You can insert, replace, delete. Text can be centered, justified, proportionally spaced, etc. Searches can be made for strings up to 26 characters long, including wildcard letters. Parts of files can be loaded, inserted, saved. Even assembly language files (with 09H codes) can be edited in the conventional assembler source structure.

In short, DYNAWORD does a lot while being very easy to use.

DYNAWORD requires 128K of RAM, one disk drive, and MS DOS 1.1 or higher. It can be used with any 80-column (or wider) printer. Compatible with the Tandy 1000/1200HD, AT&T, and Compaq.

Price: \$59.95 Diskette

The GOLFER'S DATABASE will help you improve your golf game by allowing you to easily organize and analyze your own personal scoring characteristics, thereby allowing you to better utilize your practice time.

Requires 32K.

Price: \$29.95 Diskette

### AWRITER WORD PROCESSOR (Atari only)

AWRITER brings sophisticated word processing power to the Atari. It can help with your personal and business correspondence, term papers, reports, and mass mailings.

Text is easily entered using the familiar Atari key functions like insert, delete, clear, tab, and cursor movement. Plus, AWRITER offers many powerful features to make editing and print formatting easier. You can duplicate or move blocks of text; search for or replace words or phrases one at a time or all at once; change line spacing, margins, or type font anywhere within the document; select underline, bold face, elongated, condensed, or any of your printer's special features with a single character.

You do not have to memorize complicated codes. AWRITER offers a "Macro" feature that allows you to create your own printer commands. AWRITER does not limit you to using a particular brand of printer, either. You can easily define the "Macro" table to suit your printer, using mnemonic codes that you will remember. In

### CHINESE WRITER (Commodore C-64 only)

CHINESE WRITER is a Chinese language word processor system. It changes the Commodore 64 into a Chinese typewriter which not only can type regular sized, but also large-sized Chinese characters as well as graphics. In addition, the text created can be saved to disk and later manipulated.

The characters are saved on a database currently occupying two floppy disks. Each disk contains space for 6550 Chinese characters. At present there are over 1,300 characters in the database.

An editor is included to give you the ability to add, change, or copy characters.

Dictionary utilities have been provided to print the characters in the database along with their corresponding keys.

The system is very flexible. There is no limit to the length of text files that can be created. The text itself can be a mixture of regular and large Chinese characters and graphics. Text files read from top to bottom, right to left, are just as easy to create as files that read from left to right, top to bottom.

The CHINESE WRITER system is designed to run on a Commodore 64 with one Vic-1541 disk drive and a Vic-1525 Graphic Printer.

Price: \$49.95 Three Diskettes

Sample display:

中文通用系統

「中文通用系統」是編中文處理機。它使「C-64」電腦變成一台好用的中文打字機。它不僅能打出一般常用的字體，也可打出較大的字體，或者畫出各種圖案。除此以外，用「中文通用系統」創造的文章，可以保留在磁碟上，隨時以換再處理。

儲存中文字的資料庫是保存在兩個磁碟上特別處理的磁碟裏，每一個磁碟可有六十五百五十個中文字。目前，資料庫中有一千三百多個字。

此系統並包括有編輯功能，讓使用者能增加、改變、或者抄印中文字，並且查看資料庫中的某一特別字。

類似字庫功能的模式也增加在此系統中，讓使用者能印出資料庫中的字及其對應的號碼。

「中文通用系統」非常耐用。要創造的文章，是根據有限限制，而文章的本身可以用普通字體、大號字體、或者圖案來表示。文章從上到下，不從右到左，或者從左到右一律好處理。

Price: \$29.95 Diskette

In addition, the "Macro" table, with English descriptions of the different codes, can be displayed or printed out for easy reference.

AWRITER offers complete flexibility in communicating with peripheral devices. Input/output can be directed to any device (printer, cassette, or as many disk drives as your system uses).

With a 48K Atari and one disk drive, you start out with approximately 22K of memory available for text. For very long documents, AWRITER will chain files together while printing. You can also append files to text in memory to piece together a document from standard files.

AWRITER makes it easy to prepare a very professional looking document. Page numbering is handled automatically, as well as multi-line headers and trailers. AWRITER even has sophisticated features like widow handling so that a new paragraph will not start on the last line of a page. You may select fully justified text, single or continuous forms, starting page number, and so on.

If you need to use them, AWRITER has very powerful features not included in many word processors. DOS utilities are built right in so that you can get a disk directory (with optional hard copy). You can also copy, rename, erase, protect, or unprotect files, and format blank diskettes. You may even edit BASIC programs.

If you do large mailings, AWRITER can save you much time. "Fill-in-the-blanks" forms can be used and can even be interfaced to an AWRITER data base. AWRITER will help you create a data base containing multi-field records and you can command AWRITER to selectively retrieve records from the data base. This feature is invaluable in small business applications. The built-in data-base manager can create data-base files, modify records, and query records (with optional hard-copy listing).

AWRITER is one of the best, most powerful word processors available for the Atari computer. It is easy to learn and use for the beginner, and yet can meet the needs of the most demanding user. And that's not all; it's priced well below its competition, too.

Requires 48K and one disk drive.

Price: \$39.95 Diskette

### TEXT MASTER (Apple 32K, diskette only)

TEXT MASTER is a general-purpose text editor for the Apple II computer. It features powerful English-oriented commands which permit the complete manipulation of textual information. The information treated may be correspondence, computer programs, data to be used by other programs, and more. TEXT MASTER also interfaces with any printer connected to your Apple. The minimum system requirements are 32K of RAM, Applesoft on ROM, and at least one DOS 3.3 disk system. TEXT MASTER can process any length file segment by segment. Thus it is possible to process files as large as a diskette. Comes complete with an efficient 16-page manual. TEXT MASTER is equivalent in capability to many word processing systems costing many times as much.

The commands available in TEXT MASTER are:

COLLECT	USE	EXECUTE	NONUM
INSERT	MERGE	STOP	RENUM
DELETE	SAVE	COPY	FREE
REPLACE	WAIT	MOVE	LENGTH
LIST	RESAVE	CLEAR	AUTO
RETRY	APPEND	SET	MANUAL
CHANGE	SCRATCH	SHOW	CATALOG
MODIFY	COMPARE	NUM	DISPLAY
HELP			

Price: \$29.95 Diskette

### GOLF HANDICAPPER (Commodore 64 only)

GOLF HANDICAPPER is a data base system designed specifically for golfers. For each disk you can maintain data on up to 149 members, including the member's name, 20 most-recent scores, rounds played, best score, differentials for each score, stroke count instructions, and the player's handicap. Each record may be easily edited, and handicap sheets printed. The handicap can be based on the best 1 of 5 to the best 10 of 20. As scores are added beyond the twentieth, the oldest scores are dropped. Needless to say, GOLF HANDICAPPER is easy to use.

Requires a Commodore 1525 (or compatible) printer.

Price: \$39.95 Diskette

### THOROUGHbred HANDICAPPER II (IBM only)

THOROUGHbred HANDICAPPER II is a computerized system that analyzes thoroughbred horse races and helps to predict the winners. It calls on the computer's ability to manipulate data at blinding speed and with pinpoint accuracy.

The handicapping system used is based on a statistical analysis of thousands of horse races. The factors most effective in determining winners have been isolated and selected.

To use the program, the user enters past performance data from the Daily Racing Form. THOROUGHbred HANDICAPPER II then predicts the order of finish and gives an odds-line.

The features included are:

- Sprint/route
- Class
- Track
- Track conditions
- Positions at points of call in previous race(s)
- Speed rating
- Weight carried

The results shown are:

- Projected order of finish
- Points
- Minimum odds at which to pick horse

Although there are no guarantees, we think you will find this package very effective.

Requires 128K.

Price: \$49.95 Diskette

### NFL HANDICAPPER (Available for all computers)

NFL HANDICAPPER uses multiple linear regression to statistically handicap the National Football League. All you need to do is enter the results of past games. After 30 or more sets of scores have been entered, you can start to handicap. For example, each week you can enter the scores for that week and NFL HANDICAPPER will give you the handicap for the next week. That's all there is to it. As for credibility, NFL HANDICAPPER has, in the past, been correct in about 60% of its top picks against the line. There are no guarantees that it will do as well in the future, but the prediction technique used is pretty good!

Price: \$59.95 Diskette  
\$62.45 8-inch CP/M Disk

### THE ODDSMAKER (Apple, C-64, and IBM only)

THE ODDSMAKER is a parimutuel betting system for up to 14 betting pools in a single betting event. THE ODDSMAKER accepts bets, prints tickets, and calculates the odds and pay outs. A number of information screens can be displayed while bets are entered.

Information screens include the current odds, pay outs, and amount bet for each pool, and custom announcements. Information screens are instantly updated as each bet is entered.

Additional features include the provision for a "house cut", which is deducted before pay outs are calculated.

All the betting information for a betting event can be saved on the disk and then restored at a later time. This feature allows THE ODDSMAKER to handle up to 14 different betting events simultaneously.

SPORTS: THE ODDSMAKER will live up the action when friends are over to watch a sports event on TV! The "house cut" pays for the refreshments!

BUSINESS: THE ODDSMAKER will compute the odds for success when you enter mail order response statistics for different products!

OFFICE POOLS: THE ODDSMAKER will be the book-keeper for your next office pool! If the event is the arrival of a new baby, the "house cut" pays for the shower gift.

EDUCATION: THE ODDSMAKER demonstrates how odds are calculated and how pay outs are figured in a parimutuel betting system!

**THE ODDSMAKER is designed for entertainment use only.**

Price: \$39.95 Diskette

### NBA HANDICAPPER II (Available for all computers)

NOTE: This release of NBAHCP includes an automatic regression update scheme which continuously fine-tunes the technique week by week.

NBAHCP is designed to handicap basketball games in the NBA. The program maintains information on past games and uses these data to predict future results. The coefficients used in the prediction process were obtained from a study of two years of NBA data employing the statistical technique of multiple linear regression. However, you do not have to know anything about mathematics to use NBAHCP.

In addition to predicting the game scores, NBAHCP will tell you if the prediction is a good bet. Predictions which are labeled "GOOD BETS" have been correct about 60% of the time in the past. This is sufficient to make money against the odds in places where gambling is legal. The predictions which are not labeled as good bets have been correct about 55% of the time in the past, which is much better than the usual handicapper can do when betting against the line. However, there is no guarantee for the future!

Requires 48K.

Price: \$36.95 Cassette  
\$39.95 Diskette  
\$42.45 8-inch CP/M Disk



### ENDORSEMENT:

HODGE PODGE has recently been "strongly endorsed" in the book "Teach: Achieving Equity and Excellence in Schools," by Joe Nathan (Pilgrim Press).

**LOTTO MASTER**

(Apple, CP/M, IBM, and TRS-80 only)

LOTTO MASTER provides support and assistance to today's lottery player. Its data base allows you to track winning numbers and analyze them for projecting the future. By combining knowledge of the past and the power of your computer, you may gain insight as to what the trends have been (and will be!).

LOTTO MASTER can be customized for any state lottery; you can play and track one or several different lotteries. It can also be altered should your state change the lottery from 5/30 to 6/49 or any combination up to 9/99.

When you generate a bet, your "lucky" number or numbers can be included. You can also include the most frequent past winning numbers with your lucky number(s). You may try many schemes and record your results.

Available for: CP/M and IBM, 80-column screen display. Maximum number of bets = 1,000.

Available for: Apple II & II+, TRS-80 III & IV, 40-column screen display. Maximum number of bets is 500.

Requires one disk drive, 48K or more memory. A printer is a recommended option.

Price: \$19.95 Diskette

**UNSOLICITED CHEERS!**

Here is some enthusiastic (and unsolicited) correspondence from a user of DYNACOMP's HANDICAPPER (and he is not the first to contact us with such a glowing report!):

"Using your HANDICAPPER program, I have hit 3 trifectas at Belmont Park, 2 at Finger Lakes, and 2 at Fort Erie. I also hit the win-four at Fort Erie.

"Please notify me when you will have a handicapping program for the harness-pacers and trotters."

S. Suska, Kenmore, NY

"P.S. The trifectas were won by boxing the three or four top HANDICAPPER picks."

**HARNESS HANDICAPPER**

(Apple, IBM, and CP/M only)

HARNESS HANDICAPPER guides you step-by-step through the analysis of each horse's past performance chart in your track program by means of a series of easy to follow screen prompts, questions, and menus. The output is a graded line of numerical ratings displayed on your printer.

The program manual is much more than just an operator's guide. Each step is clearly explained in relation to the underlying handicapping principles. The insights provided on the requirements for successful harness wagering are alone worth the price of the program.

The key to catching big payoffs in exacta and trifecta wagering with limited investment is revealed in a unique approach to the analysis of the graded line.

The author is a professional handicapper with more than 35 years' experience in both thoroughbred and harness racing and is a member of the U.S. Harness Writers' Association.

HARNESS HANDICAPPER requires 48K of RAM and a printer.

Price: \$59.95 Diskette

**HANDICAPPER**

(available for all computers)

HANDICAPPER is a handicapping scheme designed for thoroughbred races of lengths 6, 6 1/2, or 7 furlongs. It was designed by a mathematician and has been tested by professional bettors and handicappers. In general, you can expect HANDICAPPER to produce the winning horse about 40% of the time. However, in certain instances, it can be much more accurate.

The information required by the computer is:

1. The length of the race.
2. The length of the horse's previous race.
3. In some cases, the length of the next to last race for the horse.
4. The horse's position at points of call in the previous race.
5. The horse's position at points of call in the next to last race.
6. The type of race today.
7. The type of the previous race.
8. The horse's post position today (determined by his position in the RACING FORM).
9. The horse's post position in his previous race.
10. The number of first and second place finishes for the past two years.
11. The number of starts the past two years.

As you can see, this is the same information used by the professionals! The problem is, what if everyone used HANDICAPPER?

Price: \$29.95 Cassette  
\$33.95 Diskette  
\$36.45 Disk



**HANDICAPPER II**

(Available for all computers)

Now available after five years of research! HANDICAPPER II. The only complete handicapping system on the market.

No system can work well unless it allows you to handicap prior to the races, using past performance information, and then look for the "overlays" at the track. Finding the right bets at the track is very much like finding the right stock to buy. Some are undervalued and some are overpriced. To make money, you must pick the horses whose odds for winning are greater than those set by the bettors at the track. HANDICAPPER II does this using the latest in scientific principles to calculate each horse's probability of winning, given its past performance and its position in the current race. Variables included are the type of race, length of last race, previous positions at points of call, lengths ahead or behind at finish of last race, number of firsts and seconds in the last two years, and the number of starts in the last two years.

As an extra bonus, you get the Kelly money management system and a new technique for finding place and show bets. HANDICAPPER II is the complete system for your day at the races. For 6-, 6½-, or 7-furlong races.

The problem is, what if everyone used HANDICAPPER II?

Requires 32K.

Price: \$49.95 Cassette  
\$53.95 Diskette



Previous purchasers of HANDICAPPER may upgrade to HANDICAPPER II by returning their original HANDICAPPER cassette, diskette, or disk along with a check, money order, or Master Card or VISA number (plus expiration date) for \$20.00 Include \$3.50 for shipping

**SL-MICRO**

(IBM and CP/M only)

SL-MICRO is an easy-to-use statistical language which should already be familiar to many users of statistical packages on mainframes. SL-MICRO can process large data files containing up to 32,600 cases with 200 variables. Professional results are produced very rapidly.

The procedures implemented include frequencies, crosstabs, descriptive, Pearson correlation and multiple regression, breakdown, and ANOVA (up to 5-way). The frequencies procedure calculates counts and percentages for categorical variables with statistics and histograms as optional output. The crosstabs procedure calculates two-way and three-way crosstabulation tables and includes chi-square statistic. Both frequencies and crosstabs can handle real and alphanumeric data as well as the usual integer data. Descriptive calculates descriptive statistics. The Pearson correlation procedure also includes the t-statistic and a covariance table as options. The multiple regression routine performs either stepwise or blockwise multiple linear regressions. It can also do polynomial regression by using the data transformation routines to calculate quadratic or cubic terms. Interaction terms can be calculated in the same way. The user can also specify the order of inclusion of variables in the equation using hierarchical inclusion levels. The Longley regression test has been used to check accuracy. SL-MICRO produces coefficients to the same accuracy as SPSS on a mainframe.

SL-MICRO includes a powerful group of data transformation and selection commands. The compute command can calculate new variables from existing variables using simple algebraic expressions. The recode command can be used to categorize metric variables or to convert alphanumeric to numeric variables. The IF command allows the user to calculate new variables only under specified conditions. The SELECT IF command selects a subset of the data file for processing. SL-MICRO also has functions including logarithmic and trigonometric which can be used for more complex operations.

SL-MICRO includes many features to make your output more professional and easily understood. These features include variable and value labels, report titles, and long variable names. The output is designed for eighty-column printers.

Other features have been provided to make SL-MICRO easy to use. These features include English error messages and missing values processing in all statistical procedures. SL-MICRO is also compatible with most database systems. It can read files with either fixed-field records terminated by carriage returns or with comma delimited fields. You can also use most word processors or text editors with SL-MICRO.

**Analysis of Variance**

ANOVA				
SOURCE OF VARIATION	DF	SUM OF SQUARES	MEAN SQUARE	F-VALUE
TOTAL EFFECTS	5	4016.056	803.211	23.497
MAIN EFFECTS				
FACE CSIZE	2	152.111	76.056	2.211
FACE CSIZE	2	304.889	152.444	4.460
2-WAY INTERACTIONS				
FACE*CSIZE	2	359.256	179.628	5.259
RESIDUAL TOTAL	138	4717.250	34.183	
TOTAL	143	8733.306	61.072	

OVERALL MEAN = 42.431  
THERE WERE 144 VALID CASES AND 0 MISSING CASES.

SL-MICRO is available for the IBM PC under PC-DOS and for most machines running MS-DOS. It is also available for CP/M-86 in IBM PC or 8-inch formats. Both 16-bit versions require 128K of memory and two disk drives or a hard disk.

CP/M versions are available for Kaypro, Osborne, Apple, etc.

Price: \$229.95 Diskette or 8-inch CP/M Disk

**Crosstabulation Tables**

PLAYACT	HOLD PLAY ACTIVITY			BY WE	WEATHER
	COUNT	NO			
	ROW PCT	CLEAR	COLD	RAINY	ROW TOTAL
	COL PCT	1 2 3			
	TOT PCT				
TELEVISION	1	44.0	33.3	22.2	37.5
		28.0	42.9	44.7	
		16.7	12.3	8.3	
INSIDE TOYS	2	44.7	33.3	0.0	12.5
		14.3	14.3	0.0	
		8.3	4.2	0.0	
OUTSIDE TOYS	3	75.0	25.0	0.0	14.7
		21.4	14.3	0.0	
		12.5	4.2	0.0	
OUTSIDE PLAYMAT	4	33.3	33.3	33.3	12.5
		7.1	14.3	7.1	
		4.2	4.2	4.2	
INSIDE ADULTS	5	100.0	0.0	0.0	12.5
		21.4	0.0	0.0	
		12.5	0.0	0.0	
OUTSIDE ADULT	6	50.0	50.0	0.0	8.3
		7.1	14.3	0.0	
		4.2	4.2	0.0	
COLUN TOTAL		14	14	14	24
TOTAL		58.3	29.2	12.3	100.0

CHI SQUARE = 4.26198 WITH 10 DEGREES OF FREEDOM.  
NUMBER OF MISSING OBSERVATIONS = 1

**Multiple Regression**

DEPENDENT VARIABLE	HEALTHCOST	BILLIONS OF DOLLARS		
MEAN RESPONSE	109.329	570.847		
VARIABLES ENTERED ON STEP 1				
CP1	CONSUMER PRICE INDEX			
0.9977	MULTIPLE R			
0.9954	R SQUARE			
0.9950	ADJUSTED R SQUARE			
4.3728	STANDARD ERROR			
ANALYSIS OF VARIANCE				
DF	SUM OF SQUARES	MEAN SQUARE		
1	67176.583	67176.583		
15	313.652	20.910		
REGRESSION RESIDUAL				
F				
3212.429				
VARIABLES IN THE EQUATION :				
VARIABLE	B	STD ERROR B	F	BETA
CP1 (CONSTANT)	1.3813	0.0284	3212.429	0.9977
	-86.4476			
VARIABLES NOT IN THE EQUATION :				
VARIABLE	PARTIAL	TOLERANCE	F	
ENERGY	0.8454	0.0000	41.7485	
GRANDS	0.7361	0.0000	16.5811	
YEARS	0.5357	0.0000	5.8342	
Descriptive Statistics				
TPRICE	PRICE PER 100 TONELS			
MEAN	0.659	STD ERR	0.049	STD DEV
VARIANCE	0.072	KURTOSIS	6.793	SKEWNESS
RANGE	1.446	KURTOSIS	0.314	MAXIMUM
				1.740
VALID CASES	30	MISSING CASES	0	

## SPRING-STAT™ MULTIVARIATE STATISTICS (IBM only)

SPRING-STAT is designed to meet the data analysis needs of business, social science, market research, economics, financial, engineering, and academic professionals. While these needs have been met in the past by mainframe packages (and more recently by downscaled or expensive versions of these packages), SPRING-STAT offers some unique features:

- It's comfortable to learn and use. The entire system is prompt/menu driven and interactive.
- The system is integrated and modular. This means that you need buy only those modules that you want. It's a low-risk way to familiarize yourself with the system. If you like what you've bought, you can always add more modules.
- The 200+ page manual covers all aspects of the system. Sample data and on-screen instructions are also included.
- Data is stored in ASCII format which means that it's relatively easy to exchange data with other sources. The SCREEN EDITOR MODULE can also read DIF files.

The following provisions are available in modules (see below) for entering and editing data:

The DATABASE MODULE allows up to 10,000 records with up to 500 variables (fields) per record. You can design custom databases interactively and add records, delete records, change fields within records, search and sort records, and design custom report formats. You can also append files and create sub-files that include only those variables that you specify, and only those records that meet the conditions you indicate. In fact, you can use this database module for non-statistical applications (mailing lists, record catalogs, etc.) because all the data is stored in ASCII format.

The TRANSFORMATION MODULE allows you to create one or more new variables using a BASIC-like interpreter that supports arithmetic (^, +, -, \*, /), logical (IF, THEN, ELSE, AND, OR, >, <, >=, <=, =, <>), and function (SQR, SIN, COS, TAN, ATN, INT, LOG, EXP, ABS, NEG) commands. You can include up to 26 existing variables as well as numeric constants when creating the formula for computing a new variable. The TRANSFORMATION MODULE also allows you to recode variables (alphanumeric codes can be changed to numeric codes; continuous variables can be changed to categorical values representing intervals), and to transform variables to normal or standardized scores.

A spreadsheet-like SCREEN EDITOR MODULE is available for handling smaller jobs. This editor can read and write files that are compatible with the DATABASE MODULE, read/write files in its own unique format, and read DIF files. If a job is relatively small (a maximum of 40 observations and 20 variables), this module can be used to create and edit the data in a more convenient fashion than when using the DATABASE MODULE. This module is the only data entry/edit method acceptable to the MULTIDIMENSIONAL SCALING AND HIERARCHICAL CLUSTERING MODULE.

The modules:

- 1. DATABASE MODULE** ..... Price: \$39.95 Diskette
  - Menu driven. No commands to remember.
  - Maximum of 10,000 records, 500 variables/fields, 50 characters per variable/field.
  - Add records.
  - Edit fields within records.
  - Delete records meeting user specifications.
  - Sort on any variable/field.
  - Search records by record number or range of record numbers.
  - Search on up to 8 variables simultaneously with relational specifications (>, <, = [includes wild card option], AND, OR).

- Custom design database and report formats.
- Display records on screen or printer. Regular and compressed mode available for printer (IBM printer or compatible).
- Merge two files with identical field specs.
- Create sub-files that include only user-specified variables and observations.
- Reads and writes ASCII files.
- Access to directory and many DOS commands from within program.

- 2. TRANSFORM MODULE** ..... Price: \$39.95 Diskette
  - Requires DATABASE MODULE. Same record and variable specifications as DATABASE MODULE.
  - Menu/prompt driven.
  - Create up to 10 new variables.
  - BASIC-like interpreter supports following operators: ARITHMETIC (^, +, -, \*, /, +, -) LOGICAL (IF, THEN, ELSE, AND, OR, >, <, >=, <=, =, <>) FUNCTION (SQR, SIN, COS, TAN, ATN, INT, LOG, EXP, ABS, NEG)
  - Use up to 26 existing variables and/or numeric constants to create formula for calculating each new variable.
  - Categorize metric variables or convert alphanumeric to numeric variables.
  - Compute standard or normal scores.
  - Compute terms for polynomial regression.
  - Compute dummy variables or interaction (e.g., cross product) terms.
  - Compute predictions or residuals from regression.
  - Compute factor scores or discriminant function scores.

- 3. SCREEN EDITOR MODULE** ..... Price: \$39.95 Diskette
  - Capacity: 40 observations (rows), 20 variables (columns).
  - Menu/prompt driven.
  - Reads DATABASE MODULE files. Can write DATABASE MODULE files with automatic creation of field labels and field specs.
  - Reads/writes files in its own format. (MDS & CLUSTERING MODULE can read only files in this format.)
  - Reads DIF files.
  - Four-way arrow control for accessing any row or column in data matrix with highlighted pointer.
  - Labels for both observations and variables.
  - Spreadsheet-like data entry/edit format.
  - Add/delete/change any row, column or label.
  - Compute new column with same BASIC-like interpreter that comes with TRANSFORM MODULE.
  - Display matrix on both screen and printer.

- 4. ELEMENTARY STATISTICS (UNIVARIATE ANALYSIS) MODULE** ..... Price: \$39.95 Diskette
  - Requires DATABASE MODULE. Capacity: up to 500 variables.
  - Sum of X, Sum of X<sup>2</sup>, Sum of X<sup>3</sup>.
  - Maximum, Minimum.
  - Range, Mid-range.
  - Mean, Variance, Standard Deviation, Standard Error of Mean.
  - Coefficient of skewness, Coefficient of variation.

- 5. CONTINGENCY TABLES (BI-VARIATE ANALYSIS) MODULE** ..... Price \$39.95 Diskette
  - Requires DATABASE MODULE and ELEMENTARY STATISTICS MODULE. Capacity: up to 500 variables.
  - Crosstabs of either categorical variables or continuous variables within computed intervals.
  - Row, column, and cell percentages and totals.
  - Chi Square and Contingency Coefficient.
  - Pearson's R, Bi-variate regression coefficients (where applicable).
  - Row and column means, T-test on means (where applicable).

- 6. CORRELATION MATRIX MODULE** ..... Price \$39.95 Diskette
  - Requires DATABASE MODULE. Capacity: up to 50 variables.
  - Means and Standard Deviations.
  - Sums of squares and cross products.
  - Corrected sums of squares and cross products (Dispersion Matrix).
  - Correlation Matrix.
  - Bartlett's Sphericity Test.
  - Multiple R<sup>2</sup> of each variable with others.

- 7. STEPWISE MULTIPLE REGRESSION MODULE** ..... Price: \$39.95 Diskette
  - Requires DATABASE MODULE and CORRELATION MODULE. Capacity up to 50 variables.
  - Multiple R<sup>2</sup>, Standard Error of Estimate at each step.
  - ANOVA for Regression vs. Residual at each step.
  - F to remove, F to enter, Beta Coefficient, Error of Beta, Partial R, Tolerance value for each variable at each step.
  - Provision to either enter or remove a variable at each step using the Sweep algorithm.

- 8. FACTOR ANALYSIS MODULE** ..... Price: \$39.95 Diskette
  - Requires: DATABASE MODULE and CORRELATION MODULE. Capacity up to 40 variables.
  - Principal Components using HOW algorithm for eigenstructure computations.
  - Eigenvalue, %Trace, Wilk's Lambda, Bartlett's test for each successively extracted eigenvalue/root.
  - Unrotated Factor Structure, Commonalities, Factor Score Coefficients.
  - Varimax (orthogonal) rotation.
  - Promax (oblique) rotation with Factor Structure, Factor Pattern, and Inter-factor correlations.

- 9. CANONICAL CORRELATIONS MODULE** ..... Price: \$39.95 Diskette
  - Requires DATABASE MODULE and CORRELATION MATRIX MODULE. Capacity: up to 40 variables.
  - Eigenvalues, Canonical R's, and Bartlett's test for each Canonical root.
  - Canonical Coefficients for Dependent and Independent variables.
  - Structure Correlations for Dependent and Independent variables.
  - Stewart & Love Redundancy measures.

- 10. MULTIVARIATE ANALYSIS OF VARIANCE MODULE** ..... Price: \$39.95 Diskette
  - Requires DATABASE MODULE and CORRELATION MATRIX MODULE. Capacity: up to 40 variables.
  - Group Means and Standard Deviations for each variable.
  - Univariate F-ratios and Correlation ratios (Etas) for each variable.
  - Group sample sizes and determinants for each group's correlation matrix.
  - Test for equivalence of dispersions (Box's M).
  - Tests for equivalence of centroids (Wilk's Lambda and Rao's F).
  - Multivariate Correlation Ratio (Eta).

- 11. STEPWISE MULTIPLE DISCRIMINANT ANALYSIS MODULE** ..... Price \$39.95 Diskette
  - Requires DATABASE, CORRELATION, and MULTIVARIATE ANALYSIS OF VARIANCE MODULES. Capacity: up to 40 variables.
  - Wilk's Lambda and Chi Square test on Lambda at each step.
  - F to remove, F to enter for each variable at each step.
  - Group Discriminant Coefficients for each variable at each step.
  - Provision to either enter or remove a variable at each step using the Sweep algorithm.

- 12. CANONICAL MULTIPLE DISCRIMINANT ANALYSIS MODULE** ..... Price: \$39.95 Diskette
  - Requires DATABASE, CORRELATION MATRIX, and MULTIVARIATE ANALYSIS OF VARIANCE MODULES. Capacity: up to 40 variables.
  - Eigenvalue, %Trace, Canonical R, Wilk's Lambda, and Chi Square Test on Lambda for each canonical root extracted.
  - Discriminant function coefficients for each variable on each canonical root.
  - Structure correlations for each variable on each root.
  - Group centroids for each group on each root.

- 13. MULTIDIMENSIONAL SCALING AND HIERARCHICAL CLUSTERING MODULE** ..... Price: \$39.95 Diskette
  - Requires SCREEN EDITOR MODULE. Capacity: up to 40 objects and 20 variables.
  - Means, Standard Deviations, Correlation Matrix.
  - Preliminary Solution using Principal Components.
  - Euclidean distance matrix between objects.
  - Multidimensional Scaling Solution using KYST.
  - Hierarchical Clustering of objects based on distance matrix.
  - Graphics (perceptual map of objects and variables; Dendrogram of clustering process).
  - Ability to handle both OBJECT x OBJECT and OBJECT x VARIABLE matrices.

- 14. SYSTEM MANUAL** ..... Price: \$39.95 200+ pages
 

The manual is sold separately and is required in order to use any of the above modules. The manual may be purchased by itself (non-returnable) if you wish to get a more detailed idea of what SPRING-STAT does.

Minimum computer requirements: 128K of RAM, DOS 1.1 or higher, two disk drives, and an 80-column (or wider) printer.

Ordering Information:

First, decide which modules you need, and remember to include the support modules and at least one copy of the manual. Specify both the module numbers and their names. Also indicate whether you are using a floppy or hard-disk system (we have different versions for each).

Price: \$ 39.95 Each module (diskette)  
\$ 39.95 Manual  
\$399.95 Complete system, including manual

Sorry, the complete system package cannot be further discounted or used in or towards DYNACOMP's 10%-20% quantity discounts.

## REGRESSION ANALYSIS

(Commodore 64 diskette only)

REGRESSION ANALYSIS is a multilinear regression package designed specifically for the Commodore 64 computer. It not only calculates the regression fit, but also provides fitted Y values (for given inputs), residuals, residual plots, scattergrams, variable transformations, variable naming (a very useful feature when dealing with many dimensions and several transformations), standard error of the fits and coefficients, the T-statistic, the F-statistic, the Durbin-Watson statistic, ANOVA tables, correlation matrices and more. The manual (23 pages) is clearly written and contains step-by-step instructions and examples on how to use the package. This is the best integrated and most complete multilinear regression package available for the Commodore. Printers are supported, but are not necessary.

Price: \$39.95 Diskette



### STEPWISE MULTILINEAR REGRESSION

(Available for all computers except Atari)

STEPWISE MULTILINEAR REGRESSION (SMLR) is an add-on module to be used with MULTILINEAR REGRESSION (MLR); you must have MLR to use this module.

SMLR performs an analysis somewhat differently from MLR. It fits variables in the order of their importance, thereby giving an indication of what the contribution is of each. If a variable does not significantly reduce the variance between the data and fit, it is dropped. This permits you to determine the main variables influencing your data.

SMLR also has the advantage that it can handle larger data sets than MLR. Other features provided by SMLR are:

- Variable naming (optional)
- Variable switching (even dependent-independent)
- Variable addition to a data file
- Variable removal from a data file
- Listing of data versus fit, including differences and percent differences
- Predictions for other data points
- Student-t confidence limits on predictions (Student-t values calculated internally—you do not need to use tables)
- R, R<sup>2</sup>, and standard deviation of fit
- Correlation matrix
- Printer/screen option
- Display of fit statistics as each variable is added

The number of variables and data sets is limited only by memory size. For example, most 64K machines can easily handle cases involving 10 variables and 200 data sets.

What SMLR does not do (which MLR does do) is give you estimates of the coefficient standard errors (which is very useful). However, calculating the errors in the coefficients consumes a great deal of memory and is slow to do.

Requires at least 32K and one disk drive.

Price per module: \$29.95 Diskette  
\$32.45 8-inch CP/M Disk

The STEPWISE MULTIPLE REGRESSION module and MULTILINEAR REGRESSION module may be purchased together for a combined price of \$49.95 (Diskette) or \$52.45 (8-inch CP/M Disk).

### STATSORT

(TRS-80 only)

STATSORT is a very versatile program. Among the applications: creating an index for a book, printing exam results with statistical analyses, maintaining files for collections of stamps, books, records, and tapes. STATSORT also interfaces well with other programs. STATSORT can share files with word processing programs as well as the Radio Shack statistics package. By itself, STATSORT can create, edit, sort, and merge files and perform statistical analyses on numeric fields. All-in-all a generally useful program.

Price: \$39.95 Cassette  
\$43.95 Diskette

REGRESSION I is not only a powerful statistical tool for use in the engineering, business and social sciences, it is educational as well. Because the program presents the regressed coefficients as well as their estimated error bounds, the student may learn by experience how much credence to place on the derived coefficients. In addition, he/she may also get a feel for the general types of fit associated with various levels of correlation. It is very easy for the inexperienced experimenter to be tricked by regression results, especially those having high R<sup>2</sup> values. REGRESSION I is designed to guard against this.

Accompanying REGRESSION I is a well-written 12 page users manual.

Requires 16K of program memory (Atari version requires 24K).

Price: \$19.95 Cassette  
\$23.95 Diskette  
\$26.45 8" CP/M Disk

Sample display (Atari):

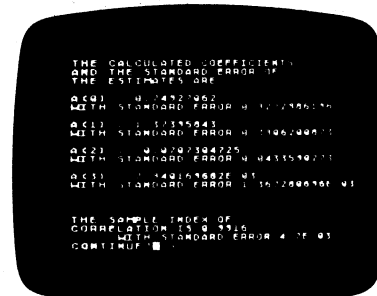

The features of REGRESSION I include:

1. Easy data entry and editing.
2. Automatic data sorting and plotting (of both the data and fitted curves).
3. Fast and accurate regression.
4. A choice of many fitting functions, including forms supplied by the user.
5. Analysis of the standard error of the derived coefficients and the correlation coefficient.
6. Data storage and retrieval.

Once the regression has been performed, the user may immediately repeat the analysis using the same data set (with editing if desired) and test other functional forms.

### REGRESSION II (PARAFIT)

(available for all computers)

PARAFIT is a parametric least squares regression program designed specifically for the determination of the non-linear coefficients in complicated mathematical expressions. This is to be contrasted with the linear polynomial coefficients calculated by REGRESSION I.

A typical problem suited for analysis by PARAFIT might be the following. Information has been collected on the failure rate of a particular product. This information is in the form of the normalized fraction of items which failed per unit time interval after production. The times at which these data were collected may not be equally spaced such that the set consists of many (f<sub>i</sub>, t<sub>i</sub>) pairs. The functional form assumed is the Weibull distribution.

$$f(t) = \left[ \frac{v \cdot (v-1)}{u} \right] \exp \left[ -(v/u)^v \right]$$

Given the f<sub>i</sub>, t<sub>i</sub> data pairs, what are the least squares regression values for the parameters u and v?

PARAFIT may be used to solve this problem. The user inserts the functional form as a BASIC program statement and runs PARAFIT. The program employs a special form of modified steepest descent to interactively determine the unknown parameters.

Features included in PARAFIT are automatic plotting of the data fitted function and residuals; cassette (or diskette) data saving and loading; and data file building/editing.

PARAFIT was designed to be easy to use as well as effective, and is an excellent companion to REGRESSION I. PARAFIT is supplied with a comprehensive 14 page manual which fully describes the program's use.

Requires 16K of program memory (Atari version requires 24K).

Price: \$19.95 Cassette  
\$23.95 Diskette  
\$26.45 8" CP/M Disk

### MULTILINEAR REGRESSION

(available for all computers)

This is the third program in the DYNACOMP statistics series. Whereas REGRESSION I and REGRESSION II (PARAFIT) are designed for analyzing bivariate data, MLR is capable of treating multi-variate situations with no limit (other than available computer memory) on the number of dimensions. The general form of the equation fitted will be  $Y = af_1(X_1) + bf_2(X_2) + cf_3(X_3) + \text{etc.}$  The variables are the X<sub>i</sub>. The regressed coefficients are a, b, c, etc. The functional forms, f<sub>i</sub>(X<sub>i</sub>), may be virtually anything. MLR automatically offers a choice of nine mathematical forms, including the logarithm and exponential, as well as the simple default  $f_i(X_i) = X_i$ . In addition, the user may replace the default form with his own function. These choices can be independently made for each dimension.

The data input to MLR may be either from the keyboard or from cassette/disk files. Data may be loaded, saved, added to, deleted, and generally edited using the convenient data manipulation procedures provided. The number of data points is limited only by the computer memory available.

The outputs from MLR are the regression coefficients and the standard error associated with these coefficients. Such error estimates are very useful, but often neglected by regression programs. MLR also supplies the standard error of the estimate for the fit and the correlation coefficient. Finally, MLR offers the opportunity to use the regressed equation to calculate values along the fitted hyper-curve.

Operationally, MLR employs two distinctly different methods for finding the regression coefficients. The first method uses matrix algebra techniques and is quite fast. The second method utilizes a very stable form of steepest descent optimization. This second approach is much slower in execution, but requires significantly less computer memory and can handle "ill-conditioned" situations with high accuracy. Also, with this technique, the fit is made one dimension at a time, and the coefficients and standard error of the fit are displayed at each step.

MLR is supplied with a 16 page manual which carefully outlines program operation.

Requires at least 16K of program memory (Atari version requires at least 24K).

Price: \$24.95 Cassette  
\$28.95 Diskette  
\$31.45 8" CP/M Disk

### COLLECTIONS

DYNACOMP offers reduced prices on the following collection:

REGRESSION I, REGRESSION II and MULTILINEAR REGRESSION are available for:

\$51.95 (3 Cassettes)  
\$63.95 (3 Diskettes)  
\$69.95 (3 8" CP/M Disks)

### STATTEST

(available for all computers)

STATTEST performs statistical tests of hypotheses and includes t-tests, chi-square tests, and F-tests as well as simple regression and a random number generator.

Data can be entered under program control or from tape or disk. Any external file which already contains data in the simple format required may also be used. Once the data is loaded, it may be edited by the program's own data manipulation routine. Data can be changed, added, deleted, or any combination thereof. Data can also be listed upon entry and after editing if desired.

When the data is ready, descriptive statistics are calculated, the hypothesis to be tested is stated, and the test is performed. Previously calculated statistics may be optionally used instead of data entry.

The 19 page instruction book is structured so as to allow the experienced statistician to make successful use of the program immediately as well as to assist the new user in the proper application of these powerful statistical tools. Reference to the theory section of the documentation should be made if statistical hypothesis testing itself is not fully understood.

STATTEST is ideal for the experienced statistician as well as the occasional user.

Tape version will run in a 16K Model I or Model III.

Price: \$29.95 Cassette  
\$33.95 Diskette  
\$36.45 CP/M Disk

### REGRESSION III (The Calibrator)

(Available for all computers except Atari and C-64)

REGRESSION III is a special applications-oriented curve-fitting package designed to be used for generating calibration curves or other fits based on the mini-max principle.

Virtually all polynomial regression procedures (e.g., REGRESSION I) use the criterion of minimizing the standard deviation between the data and the fitted polynomial. This goal has considerable merit, statistically. However, there are many situations in which this is not the correct criterion. For example, if you have a computerized thermocouple temperature measurement instrument, and you want a polynomial with which to convert the thermocouple voltages to temperature, the desired curve fit should minimize the maximum difference between the true and displayed temperatures. Minimizing the standard deviation does not do this; mini-max does.

In the application which prompted development of this program, the specified accuracy of the measurement device was improved by over 60% without any change in the instrument; mini-max coefficients were used instead of standard regression values! When doing high order (e.g.,  $N > 8$ ) order fits, a ten-fold or better reduction in maximum deviation is often achieved by using mini-max rather than straight least squares.

#### Features:

- Easy data entry and editing.
- Full data file compatibility with REGRESSION I and REGRESSION II.
- A choice of many data transformations; the user may even program in his own.
- Data storage and retrieval.

The outputs from REGRESSION III are the polynomial coefficients and the minimized maximum error.

REGRESSION III may also be used to generate mini-max polynomial approximations to functions for use in applications such as replacing tables or providing higher speed calculations. Such approximations are routinely employed in interpreters and compilers (e.g., BASIC, FORTRAN), or programs which repeatedly calculate complicated functions.

Requirements: The order of the polynomial fitted and the size of the data set is limited only by available memory. You should be able to handle most cases of interest with 48K of RAM. Written in BASIC.

Price: \$49.95 Diskette



### PC CALCULATOR PLUS (IBM only)

PC CALCULATOR turns your PC into a powerful desk-top calculator. It is easy to learn and use. Features include:

- 15-digit precision
- Roots, squares, powers, logs, factorials, exponentials
- Sine, cosine, tangent, and inverses
- Average, standard deviation, variance, max./min.
- Compounding, discounting, future/present value of annuities, loan analysis, amortization schedules, internal rate of return
- Transaction printing
- Spreadsheet

Hardware required: 128K of RAM; printer is optional.

Price: \$39.95 Diskette

### NON-LINEAR PARAMETER REGRESSION - PARAFIT II - (CP/M and IBM only)

Have you ever needed a powerful and versatile non-linear regression program which would fit complicated equations to experimental data to determine the unknown parameters? If so, read on.

PARAFIT II is generalized so that it will fit to any function that you may wish to define within the syntax constraints of the program. For example, given a set of data points (up to 200 for 128K, 50 for 64K) you may determine the A, B, C, etc., parameters (up to 10 for 128K, 5 for 64K) in equations like:

$$f(x) = A \cdot \exp(B \cdot X^2) \text{ (statistics)}$$

$$f(x) = A \cdot X \cdot (B \cdot X) \text{ (chemistry)}$$

$$f(x) = A \cdot \sin(b \cdot X) / X \text{ (engineering)}$$

$$f(x) = A \cdot \sin(B \cdot X - C) + D \cdot \sin(E \cdot X - F) \text{ (seasonal forecasting)}$$

$$f(x) = A / X \cdot \cos(B \cdot (X - C)) + D \cdot \exp[-E \cdot (X - F)^2] \text{ (???)}$$

Such equations are often encountered in science, economics, and industry. For example, the first equation is the Gaussian, which is often encountered in statistical problems (it could just as well have been the Weibull function, etc.). The second equation is the exponential, which could be encountered in reaction kinetics or sales forecasting. The third equation is a damped sine wave (possibly encountered in electronics or control systems). The fourth equation is a two frequency sinusoidal which might be used to unravel cyclical stock market action, seasonal sales, etc.). The fourth equation is weird.

PARAFIT II goes out of its way to let you input data in whatever manner you prefer. All data may be entered from the keyboard, or part of it can be entered from disk simply by telling PARAFIT II what disk file to read to find the necessary information. Or some disk file input may be used interspersed with keyboard input.

The equations are entered by simply typing them in when prompted. The functions available for constructing these equations are: +, -, \*, /, ^, =, SIN, COS, TAN, LOG10, LN, EXP, ATAN, ABS, and SQRT.

You may use BASIC-like structures or reverse Polish.

Up to ten unknown parameters may be determined. Each parameter may be initially specified, and there is complete freedom in holding some parameters constant while varying others, etc.

In calculating you may specify the maximum number of iterations allowed as well as when to quit according to how much the standard deviation of the fit has changed. At each step you may display (or print) the current standard deviation and parameter values. The final results are the fitted parameters, their standard errors (including % confidence) and the standard deviation of the fit. Also available are:

- a plot (or list) of the data and the fit.
- The partial derivative matrix.
- The parameter correlation matrix (test for independence).

Other features include optional data weighting, optional derivative specification, and a choice of two iteration schemes, fast Least Squares Matrix Analysis, and a slower (but very stable) algorithm for use on "tough" problems.

PARAFIT II is written in machine language for speed; MBASIC is not required.

Requires 64K (CP/M), 128K (IBM).

A printer is supported, but optional.

Price: \$79.95 Diskette

\$82.45 8-inch CP/M Disk

### MULTIPLE REGRESSION AND MULTIPLE/PARTIAL CORRELATION (Apple only)

MULTIPLE REGRESSION AND MULTIPLE/PARTIAL CORRELATION was designed with the statistician in mind, and is reminiscent of the statistical routines provided on the large mainframes. First you may build and edit files with the options of changing data, adding data, increasing/decreasing the number of variables, increasing/decreasing the number of individuals and shuffling variables or individuals. These data may be saved or recalled from disk (the same file format as used in PRINCIPAL COMPONENTS AND FACTOR ANALYSIS). Then you have the choice of running *stepped* regression or multiple regression with partial correlation. The stepped regression

examines the variables one at a time, choosing in turn the one which explains the most residual variation. For stepwise regression you are provided with the regression equation, standard errors of the coefficients, regression analysis of variance, and the correlation matrix. For multiple regression (without steps) you may also perform partial correlation with respect to any given variable, and the regression will be done with and without that variable.

All the functions are menu driven and the user prompts are simple and straight forward. The disk data file format is simple, making it easy to convert your current data files into a format acceptable to MULTIPLE REGRESSION AND MULTIPLE/PARTIAL CORRELATION.

Price: \$39.95 Diskette

### Q.C. PLOT (Apple only)

Q.C. PLOT provides a comprehensive statistical quality control system for those overseeing production and fabrication. You simply enter the data, and Q.C. PLOT does the calculations and produces the required control charts.

#### Features:

- Menu driven.
- Automatically produces the charts and tables of critical values, adds titles, axis marks and values, and reference values.
- Complete data entry and editing.
- Print, merge transform, and search (with select) files.
- Trial, revised control charts, and parameters are set easily and quickly.
- Screen graphics: control charts, frequency distributions, bar graphs, polygons, and distribution curve overlays.
- Graphics-ready for Epson printers. Can save graphs to data file for later printing using other (not supplied by DYNACOMP) methods (Grappler, GRAPHPAK, etc.).

#### Q.C. PLOT accepts:

- 1 to 20 sample measurements per file.
- Up to 1,600 subgroups per file.
- Up to 9 comments for assignable causes per file.
- All data for attribute and variable control charts.

#### Q.C. PLOT produces:

- Trial and revised quality control charts
  - Variable control charts
  - Mean and range charts
  - Mean and Standard Deviation charts
  - Individual Values charts
  - Subgroup Sums charts
  - Trend Charts
- Attribute Control charts
  - p chart
  - %p chart
  - np chart
  - c chart
  - u chart
- Standard Probability curve overlays to your data
- Distribution Curves
  - Hypergeometric
  - Binomial
  - Poisson
  - Normal
  - Exponential
- Additional Output
  - Parameter tables

Frequency graphs and reports  
Full and partial percentile ranks  
Data transformations  
Search and select results  
Graphs on screen, disk, or Epson printer

#### Customer comments:

"I think Q.C. PLOT is great. It's a well designed program which does the quality control necessary for our lab."

Paul Harris, Davy Laboratories  
Wisconsin

"I found it very simple to get Q.C. PLOT operational. It is a very powerful tool for statistical quality control. I'm satisfied with the program and pleased with the support."

Nick Tartaglione, Republic Plastics  
Michigan

As you can see from the sample screen displays below, the quality of the graphics is very good.

Requires 48K and 1 or 2 disk drives.

Price: \$369.95 Diskette

#### Sample displays:

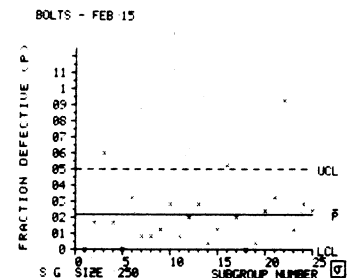
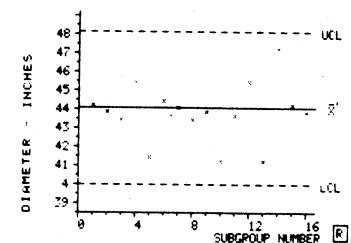

## HSD STATISTICAL SOFTWARE

(Apple only)

**Background:** DYNACOMP continually reviews (and sometimes acquires) the software products of other publishers. Our goal is to provide you with the best software available, even if it isn't written by DYNACOMP, and to offer it at a discount price. In this case we have added three popular packages from Human System Dynamics (HSD): STATS PLUS, REGRESS II (not to be confused with REGRESSION II - Parafit), and ANOVA II. Each package has received excellent reviews in the literature (see Review section). In our evaluation, we found these products to be well written and the documentation to be exceptionally complete (60 to 100 pages).

**General Specifications:** Each of the three packages is designed to be used with a 48K Apple II (plus, e, or c), one or two disk drives, and a printer (optional). Each allows you to create files, delete, edit, merge, create subfiles, search for and select particular records, transform data, etc. Also, each package can read the other's data files, as well as sequential files created by VISICALC (PRINT FORMAT). Also, each has high-resolution plotting capabilities (scatter plots, line plots, and bar graphs).

See the review section for more information.

### STATS PLUS - Price \$179.95

STATS PLUS accepts: 1 to 20 variables per file, keyboard or disk-file data, and print-format files from VISICALC.

STATS PLUS performs: data ranking, file ranking, file restructuring, 1-way to 5-way crosstabulation, 1-way to 4-way data-file search, and file and subfile creation.

STATS PLUS calculates: descriptive statistics, 14 data transformations, frequency distribution, cumulative frequency and percent, percentiles, correlation matrix, Pearson r, Spearman Rho, Kendall Tau, partial correlation, 1 or 2 predictor regression, 1-way or 2-way Randomize Anova, t-Test for independent groups, t-Test for correlated groups, t-Test against population mean, Chi-square, Fisher exact test, Mann-Whitney/Rank-Sum test, signed-ranks test, Kruskal-Wallis, Wilcoxon signed ranks, and Friedman Anova by ranks.

STATS PLUS produces: printed reports of results, printed copies of data, and plots and bar graphs on CRT or disk.

STATS PLUS sample graphics:

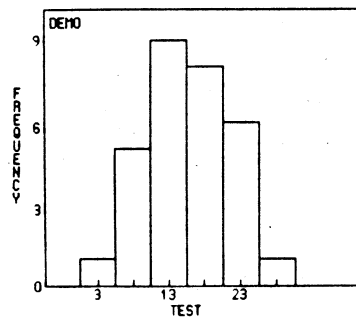

### REGRESS II - Price: \$139.95

REGRESS II accepts: 1 to 20 variables per analysis, keyboard or disk-file data, correlation data, and print-format files from VISICALC.

REGRESS II performs: regression analysis. The five regression solutions all give you a complete Anova table output, along with regression weights, t-tests, and p-values. The stepwise solution gives a summary of steps taken. All solutions produce predicted and residual scores.

REGRESS II performs: correlation analysis. You can easily obtain correlation and covariance matrices along with descriptive statistics, multiple and partial correlations, and serial correlation of residuals.

REGRESS II calculates: sum of squares (SS), mean square (MS) table, multiple correlation coefficient,  $R^2$  with error estimate, standard error, coefficients with standard error, actual/predicted/residual table, serial correlation and serial residuals, and Durbin-Watson statistic.

REGRESS II produces: printer reports of results, printer copies of data, and plots and bar graphs on CRT or Disk.

REGRESS II sample display:

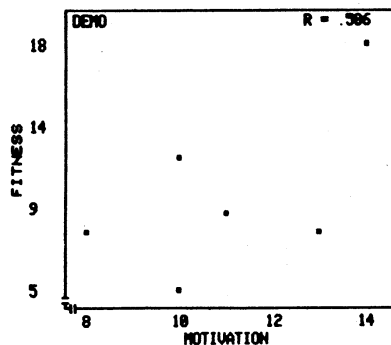

#### MULTIPLE REGRESSION MENU

1. SIMULTANEOUS SOLUTION
2. FORWARD SOLUTION
3. BACKWARD SOLUTION
4. STEPWISE SOLUTION
5. POWER POLYNOMIALS
6. RETURN TO MAIN MENU

### ANOVA II - Price: \$139.95

ANOVA II accepts: 1 to 5 factors, 2 to 36 levels per factor, randomized block design, repeated-measures designs, equal or unequal n (unweighted means analysis), randomized designs with up to 10,000 data points, mixed designs with up to 1,200 observations per group, and completely repeated measures designs with up to 1,200 data points.

ANOVA II performs: analysis of variance, analysis of covariance with a single covariate, Latin square analysis, data disk-file creation, data review/edit, data transformations (such as arcsin, power, log, ln, etc.), and data-file joining.

ANOVA II calculates: Anova tables, SS between regression, SS within regression, F values, P values, and within-group correlation.

ANOVA II produces: complete ANOVA II summary table with t-test and p-values on CRT or printer; mean, standard deviation, and sum-of-square for each cell on CRT or printer, and high-resolution plots and bar graphs on CRT or to disk files.

## HSD PC ANOVA

(IBM only)

When you use PC ANOVA, you get accuracy and speed along with ease of use. You can do sophisticated statistical work right in your own office or lab. No previous computer experience is needed to use PC ANOVA accurately and confidently. Just follow the documentation examples for all standard anova research designs.

PC ANOVA accepts DIF files created by LOTUS 1-2-3 and VISICALC. Records within a file can contain 48 fields or variables. Data file procedures include review/edit, merge files, create subfiles, delete records, delete files, print files, transform data, and more.

PC ANOVA's search-and-select option lets you create new files with selected cases. You can even choose specific cases for analysis within each statistics option.

Possible Designs with 1 to 5 Factors include:

- Randomized designs with equal or unequal n
- Between-within or split-plot designs with equal or unequal n
- Repeated measures designs with equal n
- Latin square designs
- Randomized complete blocks designs
- Analysis of covariance

Nonparametric Analysis of Variance Tests include:

- Hotelling T squared
- Kruskal Wallis H test
- Friedman ANOVA by ranks

Post Hoc Test Options for Single Factor Designs are:

- LSD test
- Tukey HSD test
- Newman Keuls test
- Duncan Multiple Range test

Analyses Produce:

- Complete anova summary table with all interaction terms, F values, and p values
- Mean, standard deviation, and sums of squares for each cell
- Graphics display of treatment means

You can also use PC ANOVA to produce black-and-white graphics from your research data. The graphics option creates high-resolution line plots or bar graphs of treatment means with or without standard error bars. To produce your graphs, you need a color/graphics card and an appropriate black-and-white or color monitor.

PC ANOVA runs on the IBM PC, IBM Jr., IBM XT, and other MS DOS personal computers. It requires 128K, two DD DS disk drives, PC or MS DOS 2.0 or higher, a color/graphics card, a compatible color or black-and-white monitor, and a compatible printer. To print graphs using PC ANOVA, you need an IBM or Epson printer with Graftrax, or a C. Itoh Prowriter. To print graphs on other printers you need the appropriate graphics dump program.

Price: \$189.95 Diskette

Sample print out:

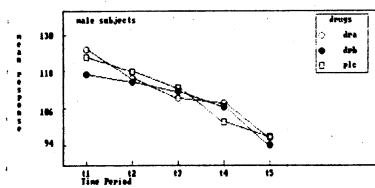

## MULTIVARIATE REGRESSION ANALYSIS

(TRS-80 and IBM only)

MULTIVARIATE REGRESSION ANALYSIS (MRA) is a DYNACOMP statistics package which complements MULTILINEAR REGRESSION (MLR). In essence, MRA approaches multivariate regression from a different computational perspective. This approach is a little slower and does not include standard errors of the estimates for the calculated coefficients. However, it does handle much larger data sets, and has a few different features. Besides the standard data editing, variable removal, etc., capabilities, MRA also includes the following:

- Reverse stepwise regression.
- Up to 54 named variables (9,999 observations for six variables).
- Tables of means, standard deviations, correlation coefficients, partial correlation coefficients.
- Min, max, skewness, and kurtosis for each variable.
- Correlation eliminations (by calculating coefficients for cross terms, squares, cubes. For example, the E and F in  $(X-E) * (Y-F)$ ).
- User defined (in BASIC) variable transformations.
- Regression coefficients, beta coefficients, F ratios, R-squared.
- Binary-to-decimal correction (to avoid single/double precision data file loading problems).
- Double-precision square-root routine.
- Calculation by correlation matrix inversion to reduce error.
- Matrix inversion test for poorly conditioned data. Inverse diagonal display.
- Residual analysis with Durbin-Watson D, one-sided U statistics.
- Scatterplot of residuals vs. dependent variable.
- Plot of residual distribution compared with normal distribution; chi-square statistic.
- Probability plot of residuals (should be straight line).

MRA comes with a 43-page manual which includes sample run information. A printer (at least 64-columns wide) is supported, but not necessary. Requires 48K (TRS-80) or 128K (IBM) to run all modules. The more memory, the larger the data array you can run.

Price: \$59.95 Diskette

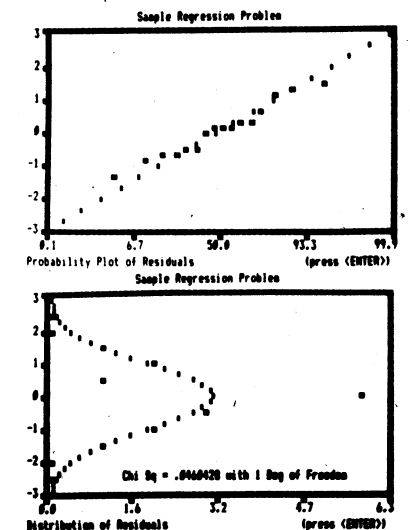

### PC STATISTICIAN (by HSD)

(IBM only)

PC STATISTICIAN is a comprehensive statistics package aimed at the user with no previous computer experience. By following examples in the manual, you can start analyzing experimental data immediately. PC STATISTICIAN accepts DIF files created by LOTUS 1-2-3 and VISICALC, or you can easily create and edit your own data files.

PC STATISTICIAN presents you with menus. You choose your analysis, give the data file name when prompted, and choose variables and cases within the file. Just answer the screen prompts. If all of your data is in a single file, the program can select your records or cases automatically. There is no problem with missing data.

PC STATISTICIAN can handle files with up to 48 fields or variables. You can review and edit, merge files, create subfiles, search and select records on up to 4 variables, delete records, delete files, rename files, or select a random sample of records.

PC STATISTICIAN also can create and print bar graphs and scatter plots with or without regression lines.

PC STATISTICIAN accepts:

- 1 to 48 variables per file
- Up to 7,000 cases per file

PC STATISTICIAN performs:

- Data ranking
- File ranking
- File restructuring
- File and Subfile creation
- Record or Case selection
- 1- to 5-way cross-tabulation
- 1- to 4-way data-file search

PC STATISTICIAN calculates:

- Descriptive statistics
- Frequency distribution
- t-Test for independent groups
- t-Test for correlated groups

- t-Test against population mean
- 1-way Anova: randomized or repeated measures
- Nonparametrics
- Five measures of correlation
- Curve fitting
- 1 to 5 predictor regression
- Contingency tables
- 17 data transformations
- Cumulative frequency and percent
- Percentiles
- Pearson r
- Kendall tau
- Spearman rho
- Chi-square
- Friedman Anova by ranks
- Wilcoxon signed ranks
- Mann-Whitney/rank-sum test
- Kruskal-Wallis
- Wald Wolfowitz runs test

PC STATISTICIAN produces:

- Presentation-quality reports
- Graphs on CRT or disk
- Printer copies of data and graphs

System requirements: 128K RAM, two disk drives, and DOS 2.0. For screen graphics, a color graphics card is required. A printer is supported. For printer copies of graphs, an IBM printer or EPSON printer (with Graftrax), or C. Itoh Prowriter is required.

Price: \$269.95

Sample print out:

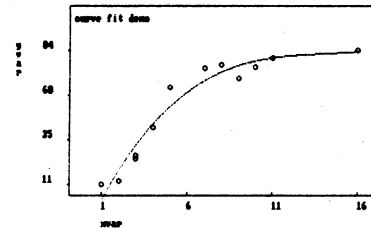

Output from ARGUS is routed to both screen and printer and includes: original data matrix, means and standard deviations, correlation matrix, Bartlett's sphericity test, multiple R-squared for each attribute, eigenvalues and factor structure, factor score coefficients, factor scores, and rotated configuration for initial estimate. Using this initial estimate, MDS is then performed with the following intermediate output: Normalized Euclidean distance matrix, step-by-step iteration history, plotting coordinates of objects and attributes, map of objects and attributes, tree diagram of clustering process.

While most of this information is implicitly contained in the maps themselves, the detailed tables for building the maps are printed out for reference. A comprehensive manual takes you in easy-to-digest steps through all of ARGUS's features.

ARGUS is available for the IBM PC under PC-DOS and requires 128K or more of RAM, two disk drives, a 25 by 80 monochrome display, and an IBM 80 CPS Matrix Printer or its functional equivalent (printer optional, but recommended).

Price: \$99.95 Diskette

### ARGUS PERCEPTUAL MAPPER

(IBM only)

ARGUS is a multidimensional scaling (MDS) and Hierarchical Clustering package for discovering hidden structure in data tables. Data can be entered either as distances (dissimilarities) between pairs of objects, or as profiles of objects on a set of attributes.

ARGUS transforms this data into a two-dimensional graph that shows the objects as labeled points and the attributes as labeled vectors. A tree diagram showing how the objects cluster together on the basis of profile similarity, is also displayed.

While MDS and Clustering are "leading edge" statistical tools, they have the unusual property of lending themselves to easy visual analysis and interpretation. ARGUS can thus be immediately useful to both laymen and professionals. It's a pattern-recognition aid that can provide an analytical edge for examining data sources ranging from survey tables to marketing summaries to spreadsheet matrices (ARGUS can read DIF files).

Working with ARGUS is straightforward and comfortable. It's menu driven, with a highlighted block pointer for each option to minimize typing errors when making choices. Data are entered and edited using a spreadsheet-like screen which also supports a full range of arithmetic and logical calculations for creating new variables from existing ones. Most file handling functions can be done from within the program without exiting to DOS.

### BASIC STATISTICAL SUBROUTINES

VOLUME I

(Available for all computers)

BASIC STATISTICAL SUBROUTINES, Volume I, is a collection of non-parametric statistics routines keyed to the text "Non-Parametric Statistics for the Behavioral Sciences" by Sidney Siegal (McGraw-Hill). The routines are written in BASIC and can all be called from an easy-to-use menu. Full facilities for data storage, retrieval and editing are also provided. Comes with a 100-plus page instruction book. The subjects covered are:

- Binomial Test
- Chi Square One Sample
- Kolmogorov-Smirnov One Sample
- One Sample Runs Test
- McNemar Test
- Sign Test
- Wilcoxon Matched Pairs Signed Ranks Test
- Walsh Test
- Randomization Test for Matched Pairs
- Fisher Exact Probability Test
- Fisher-Tocher Test
- Chi Test for Two Independent Samples-NxN Chi
- Yates 2x2 Chi
- Median Test
- Mann-Whitney U Test
- Kolmogorov-Smirnov Two Sample Test
- Wald-Wolfowitz Runs Test
- Moses Test of Extreme Reactions
- Randomization Test for 2 Independent Samples
- Cochran Q Test
- Friedman Two-Way Anova by Ranks
- NxN Chi (Chi Test for 2 Independent Samples)
- Extended Median Test
- Kruskal-Wallis Anova
- Contingency Coefficient C
- Spearman Rank Correlation Coefficient
- Kendall Rank Correlation Coefficient
- Kendall Partial Rank Correlation Coefficient
- Kendall Coefficient of Concordance

Requires 32K, one disk

Price: \$99.95

### PRINCIPAL COMPONENTS AND FACTOR ANALYSIS

(Apple, CP/M, IBM, and TRS-80 only)

PCFA is a menu-driven collection of subprograms with which you may enter and edit data and perform various calculations. For example, you may compute correlation matrices, standardize your data, calculate principal components and analyse factors, rotate your data using Kaiser's varimax method, and determine factor score coefficients and factor scores. In the principal component analysis and varimax rotation you can specify the number of decimal places accuracy required. You may also conveniently alter your raw data by increasing or decreasing the number of variables or "individuals", as well as shuffle both the variables and individuals. All in all, PCFA is a powerful multivariate analysis package. (Note: Although PCFA does the calculations, it is left to the user to evaluate the results. Therefore some familiarity with the subject is required: references are given).

Price: \$49.95 Diskette

The CP/M version requires Microsoft BASIC, release 5.0 (BASIC-80) or newer, and 64K of RAM. The Apple version requires 48K of RAM. A printer is supported but not necessary.

### DATA SMOOTHER

(available for all computers except Atari)

This package provides the user with a fast and easy means to least-squares smooth equally spaced data and plot the results. Any size data set may be treated within the memory limits of your machine. The variation in each data point is smoothed according to the weighted average of points surrounding it. The averaging span is 3 to 25 points. The order of the local smoothing is linear to quintic (first to fifth degree polynomial). Also calculated are the smoothed first and second derivatives of the data at each point.

The width of the plot is user-controlled. The software automatically considers the printer width chosen and number of data points to produce a graph having a good aspect ratio.

This program is very useful for smoothing out day-to-day stock market fluctuations in order to determine underlying trends. It is also beneficial to the business man in planning inventory based on varying sales volume. The scientist and engineer may apply the smoothing software to noisy data sets. Communications engineers can apply it to incoming data as a "digital filter."

DATA SMOOTHER is extremely well documented in the accompanying 38 page manual which describes both the theory behind the program, as well as its use.

Requires 16K.

Price: \$19.95 Cassette

\$23.95 Diskette

\$26.95 8" CP/M Disk

### STATISTICAL SAMPLE PLANNER

(Apple, CP/M, IBM, and TRS-80 only)

STATISTICAL SAMPLE PLANNER makes it easy to find the sample size and strategy that best meet your needs. This friendly program is for you if you're concerned with questions such as these:

Should I stratify or would simple random sampling be better?

If stratification, should I sample by a proportional approach or would I save money and still achieve necessary statistical precision with an optimum allocation strategy?

How should I proceed to achieve given standards of precision at the level of individual strata as well as at a population level?

For pre-specified precision total sample size, what precision and cost can be expected?

For pre-specified precision standards what sample sizes and costs will be required?

What is the smallest sample that will meet my needs?

How can I capitalize on information about individual strata (size, distribution shape, range, variation, sampling expense) to efficiently accomplish my sampling goals?

STATISTICAL SAMPLE PLANNER will be of value to you if you apply sampling techniques to survey research, market analyses, quality control or other areas involving random sampling of independent units. STATISTICAL SAMPLE PLANNER will quickly compare the benefits of optional plans you want to consider. It also makes an effective tool for teaching sampling. A clearly written 28-page manual includes theory, formulae, examples, program listing and references.

Requires 48K.

Price: \$39.95

**ANALYSIS OF VARIANCE****ANOVA**

(Available for all computers)  
(Not available on Atari cassettes)

ANOVA is actually four programs in one. Each program performs a specific task matched to the designed experiment under analysis.

1. A one-way ANOVA produces the treatment sum of square, mean square, and F ratio along with the error mean square. This algorithm accepts unequal numbers of replicates per treatment level and unlimited numbers of treatment levels and replicates.
2. Two-way ANOVA performs an analysis of either fixed or random factors with equal numbers of replicates (repeat measurements) per cell. There is no practical limit on the number of levels or replicates. Sums of squares and mean squares are printed for both factors and the interaction as well as the error sum of squares and all F ratios.
3. The "N-way" (for N up to 5 factors) will accept up to 4 levels per factor or any combination of levels not to exceed 1024 treatment combinations in 16K of core. Sums of squares and mean squares for all main effects and up to 3 factor interactions are computed. The appropriate (residual or pure error) mean square is used to compute the F ratios.
4. YATES analysis computes the mean square and half effect for two level factorial and fractional factorial experiments. All main effects and interactions are computed and printed out.

In all programs except the YATES, the means for the main factors are printed. Unlike many large computers FORTRAN-based ANOVA systems, data entry is interactive and at the user's option. A data file may be created for editing and re-entry at a later time.

Documentation (15 pages) includes a guide to experimental design and methods to compute components of variance for the random model ANOVA. Examples and test data are provided to allow the user to practice with known information before applying the programs to their own data.

Requires 16K program memory space.

Price: \$39.95 Cassette  
\$43.95 Diskette  
\$46.45 8-inch CP/M Disk

Not available on cassette for Atari and C-64.

**ATARI ORACLE**

(Atari only)

Quiet the room... dim the lights... and concentrate. Feel the eerie vibrations that permeate the atmosphere as you ask the all-knowing ATARI ORACLE your questions. Go ahead. Ask it about anything: your love life, finances, friends, or your future. The ATARI ORACLE's ghostly blue hand will spell out its startling answer — and it just may surprise you!

Simulating a mystical seance, the ATARI ORACLE can answer virtually any type of question you can think up. It will answer "yes-or-no" questions, questions that require a numerical answer, and any question beginning with the words *Who, What, Where, When, Why, and How*. When you type in your question, a glowing blue hand appears and spells out the answer.

ATARI ORACLE includes exciting options. If you have a printer, all questions and answers can be printed out during your "session" with the Oracle. There's also an Answer Editor that allows you to create your own customized versions of ATARI ORACLE. Imagine how amazed your friends will be when they see their own names spelled out by the Oracle! Great for parties!

**I CHING  
CANON OF CHANGE**

(Apple and IBM only)

Three-thousand years ago, revolution brought down the house of Shang in China, and the mandate of Heaven passed to Zhou. Thus ended the era of the tortoise oracle and bronze vessels and began the great dynasty that saw the rise of Chinese philosophy. The Zhou people knew the deepest secret of the universe, that Yin and Yang are at the root of things, that they continually change into each other, giving motion to the world. They expressed this in their oracle *I Ching*, the *Cannon of Change*.

Woven into the *I Ching* are the beliefs, values, and poetry of the Zhou people at the beginning of their millennium. The book has always been more than mere oracle to the Zhou people, who created it, and to generations that came after.

Confucius, born five-hundred years after the *I Ching*, saw it as the guide to proper conduct in harmony with Nature. His teachings remain deeply ingrained in the culture, not only of China, but also of Japan, Korea, and other countries of East Asia.

There is also a Western tradition of the *I Ching* which brings fresh insights from new points of view. Gottfried Wilhelm Leibnitz (1646-1716), the German mathematician who invented calculus, credited the *I Ching* with the notion of binary integers, the stuff of modern computers. Carl Gustav Jung (1875-1961), Swiss psychiatrist, has championed the use of the *I Ching* as an analytical tool in psychology. Between these weighty applications, the *I Ching* has been used as fortune teller, aid to meditation, and forecaster of the stock market.

The new translation of the *I Ching* used in this DYNACOMP program aims to restore the original face of the book as it was written three-thousand years ago. To that end, the findings of modern archeology and scholarship have been used to help decipher the meaning of words and phrases in the Chinese original. Such a rendition will serve the modern user who considers value judgement an individualistic and personal thing.

Indeed, the universal appeal of the *I Ching* lies in that combination of charm and depth that, while maintaining its own integrity, allows all comers to use it in a personalized way.

According to the author, Dr. K. Huang, a professor of physics at M.I.T., computerizing the *I Ching* is a natural extension of the written version. Reason: choosing a passage in the book used to require flipping three coins six times each to choose one of the more than 4,000 passages. Since computers are expert at generating random numbers, the machine does the "flipping" and picks the correct passage.

The interest in *I Ching* has increased in recent years because of the closer ties with the East. This *I Ching* program has even been discussed in *U.S.A. Today* (July 19, 1984) and *The Wall Street Journal* (June 4, 1984). Will the dragon really leap in the pool?

**Requirements:**

IBM: 64K, one disk drive, MS DOS 1.1 or higher  
Apple: 48K, one disk drive  
A printer is supported, but is not necessary.

Price: \$49.95 Diskette

Requires BASIC and 48K. A printer is supported but not necessary.

Price: \$9.95 Diskette

NOTE: ATARI ORACLE is also distributed by ANTIC®. Their price is \$12.95. Sorry, at such a low price we cannot afford to allow ATARI ORACLE to be used in or towards DYNACOMP's 10%-20% quantity discounts.

**XTRAPOLATOR  
TIME SERIES FORECASTS**

(Apple and IBM only)

XTRAPOLATOR is a comprehensive and multipurpose forecasting system. The analysis framework is based upon methodologies encompassing simple to complex extrapolative techniques. Twelve distinct forecasting methods can be applied to a data series. In addition, the competing methods are rated based upon their best fit and likelihood of accuracy. XTRAPOLATOR does not require programming experience. The user applies simple commands in a menu driven mode.

Imagine the following management scenario. You, a business analyst or manager, need to forecast a variable. You also don't want to waste time with unsophisticated tools. But the more complex methods are too abstract or are available only on expensive time-sharing systems. Or, you simply do not like the slow turn-around time available on mainframe computers. Your choice is clear. XTRAPOLATOR is the forecasting software with efficient methods offered for cost effective and convenient microcomputers.

What makes this package special?

- menu driven programs
- fast, easy data management
- competing forecast methods
- automatic best-fit curve selector
- plotting in high-resolution graphics
- uses Visicalc™ and Lotus™ data files.

Below is a brief description of some of the menu-selectable functions:

**DATAMAKING:** create data files with an upper limit of 700 observations. Update a file by adding data or changing existing data points. Copy to create duplicate files. Merge files by adding, subtracting, multiplying, or dividing. Delete data from the beginning or end of a file. Data can be scaled by any arithmetic operator.

**PLOTTER:** Graph your historical and forecast data in a high-resolution mode. You may choose to develop either univariate or bivariate line graphs. You even have the choice to save the plot for future printing.

**FORECAST METHODS:** Select Linear Trend to derive a straight line forecast. Choose Exponential Curve to develop a forecast that accelerates over time. Use Third Order Polynomial for S-shaped curves. Apply Moving Average to volatile data. Select Double Moving Average

**MICROBJ  
BOX JENKINS FORECASTING  
ARIMA MODELING**

(Apple and IBM only)

MICROBJ is a powerful, sophisticated, and multipurpose time series forecasting system based on the BOX-JENKINS methodology. MICROBJ does not require programming experience. By using simple commands, you easily proceed through the data manipulation, analysis, graphics, and forecasting modules. Not only do you have mainframe analysis capability at your fingertips, but the cost is less and the ease of use is much greater. Also, MICROBJ is fast (because it's compiled).

Here is an abbreviated listing of MICROBJ's capabilities for ARIMA model building:

**IDENTIFICATION CAPABILITIES**

- Log or Exponential Transformation
- Seasonal and Non-Seasonal Differencing
- Standard Deviation/Mean Plots in groups of 4, 8, & 12
- Descriptive Statistics: Mean, Variance, Standard Deviation, Coefficient of Variation
- Autocorrelation, Partial Autocorrelation up to 37 lags, Listed and Plotted
- Estimated Standard Errors, Chi Square with Degrees of Freedom

to add a trend to your forecast. Choose Exponential Smoothing to weight historical data before forecasting. And there are still six other forecasting methods to apply.

**DIF FILES:** Store data in translated formats. This way you can use Visicalc™ and Lotus™ created files.

**OTHER OPTIONS** include selection of the forecast horizon, listing the historical plus forecast data and listing the fitted values plus forecast. You may save the listings to a file. You may choose to Seasonally Adjust your data and forecast by a ratio to moving average method. Rate your method based upon its R-squared value. Or, let the program automatically guide you to the best method.

XTRAPOLATOR is very easy to use and includes a very carefully prepared manual.

It requires 128K (IBM PC), 48K (Apple) and one or two disk drives. A printer is supported but not required.

Price: \$189.95 Diskette

NOTE: XTRAPOLATOR will work with one or two disk drives. When you order, state how many drives you have.

Sample print out:

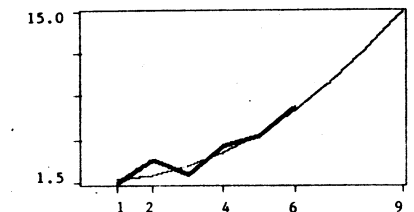

RATINGS	
'10'	IS PERFECT OVER HISTORICAL DATA
8.6	LINEAR TREND
9.2	EXPONENTIAL CURVE
8.2	GEOMETRIC CURVE
9.1	SECOND ORDER POLYNOMIAL
8.8	THIRD ORDER POLYNOMIAL
5.4	AUTOREGRESSIVE TREND
8.8	GOMPERTZ CURVE
5.7	MOVING AVERAGE
8.2	DOUBLE MOVING AVERAGE
1.2	EXPONENTIAL SMOOTHING
7	DOUBLE EXPONENTIAL SMOOTHING
8.6	TRIPLE EXPONENTIAL SMOOTHING

**ESTIMATION CAPABILITIES**

- Parsimonious Modeling Ability with up to 10 parameters
- Multiplicative and Additive Models of any Order
- Maximum Likelihood, Marquardt Algorithm Includes Backforecasting
- Parameter Estimates Include Standard Errors
- Residuals, Fitted Values, Residual Variance and Standard Deviation, Auto and Partial Autocorrelations
- Estimated Model Stored for Forecasting

**FORECASTING CAPABILITIES**

- Point Forecasts and 95% Confidence Intervals
- Plots and Listings
- Automatic Transformation from log based models

The 52-page MICROBJ manual includes not only excellent operating instructions, but also clear tutorials.

Time series analysis has evolved into widely used technique in economics, finance, marketing, and engineering applications. Previously, this analytical method required cumbersome and expensive mainframe computers. The other option was to use very costly time-sharing systems. Now, you, the professional forecaster, can let the data tell its story on a microcomputer.

Requires 256K (IBM PC), 64K (Apple II series), and one or two disk drives. A printer is supported but not required.

Price: \$289.95 Diskette



**NUAMETRICS  
ECONOMETRIC ANALYSIS**  
(Apple and IBM only)

NUAMETRICS is the user friendly menu-driven program for professionals interested in serious econometric analysis. It incorporates widely used statistical methods with simple operational instructions. By controlling the computer's arrow keys and the return key, a user can move from menu to menu developing data files or selecting procedural methods. There are no special commands to memorize. NUAMETRICS allows the professional to use time efficiently developing models, not learning another computer system.

Single and multiple regression techniques are the most widely known and frequently used tools for statistical analysis and forecasting. These models describe a relationship between a variable (dependent) of interest and one or more related explanatory variables. Econometric analysis is extremely attractive to managers. It enhances the understanding of economic relationships and provides quantitative estimates. Now, you can avoid expensive time-sharing systems and slow turn-around main-frame computers.

What makes NUAMETRICS special?

- menu driven programs
- fast, easy data management
- features seasonal adjustments
- plotting in high-resolution graphics
- uses Visicalc™ and Lotus™ data files.

Here is a brief description of some of the menu options:

**DATAMAKING:** Create data files. Update or delete files instantly with both historical or cross-sectional data. Files can be copied, listed, and combined in any arithmetic form. Datamaking allows the user to quickly change data to logs, antilogs, squares, square roots, reciprocals, moving averages, and percentages. The index module includes a seasonal adjustment feature. Data can be lagged or differenced to any order.

**PLOTTER:** Choose from a menu of choices to provide univariate, bivariate graphics and scatter diagrams in a high-resolution mode.

**FORECASTING COLLECTION**

MICROBJ, XTRAPOLATOR, and NUAMETRICS may be purchased as a collection for \$539.95. Collections are not eligible for further quantity (10%–20%) discounts.

**TIME SERIES / FORECASTING**  
(Apple only)

TIME SERIES is a menu-driven package consisting of several programs for data file creation, editing, and analysis. The analysis routines are largely based on the methods discussed in the text by Freund and Williams. The TIME SERIES files may be examined using one of three trend models: linear, quadratic, and exponential. Detrended and detrended/deseasonalized data files can be set up while running the time series analysis, and they may then be tested using the autocorrelation routine (included). This allows you to determine how well the model works by examining the residual for randomness.

The manual and disk include a time series data example derived from the text.

Requires 48K. Price: \$29.95

**REGRESSION ANALYSIS:** Use up to seven explanatory variables and six-hundred observations. The coefficient of determination, its corrected version, the standard error of the estimate, the F value, and the standard errors of the parameter estimates are included in the main output. You may select correlation coefficients of the independent variables or a forecast module that allows for predictions and storage in a data file.

**GENERAL STATISTICS:** Sort and rank according to ordinal or cardinal values. Other features include frequency distributions, summary statistics (mean, median, mode, skewness, variance, standard deviation, and coefficient of variation). You can perform an autocorrelation test to check for stationarity. Simple correlation and elasticity estimates are easily developed. Forecasts can be tracked against actuals, with several statistics.

**DIF FILES:** Provides translation of data so that you can interface to popular programs such as Visicalc™ and Lotus™.

**RESIDUAL ANALYSIS:** Allows the listing of residuals, their autocorrelation function, the fitted values, and the Durbin-Watson statistic.

Both the software and manual are designed for ease of use and convenience.

Requires 128K (IBM PC), 48K (Apple), and one or two disk drives. A printer is supported, but not necessary.

Price: \$189.95 Diskette

Sample Print Out:

**SALES REGRESSION N = 8**  
\*\*\*\*\*

PARAMETER	ESTIMATE	STD. ERROR
INTERCEPT	599.533	93.8393
PRICE	-59.2784	4.922
ADS	2.9506	2:1374

STATISTIC	VALUE
R SQD	.9728
R SQD (COR)	.9682
S.E.E.	21.6702
F VALUE	89.2507

**DEPENDENT VARIABLE LISTING**  
\*\*\*\*\*

ACTUAL	ESTIMATE	RESIDUAL
100	95.2663	4.7337
150	160.4459	-10.4459
200	228.576	-28.576
300	287.8544	12.1456
325	299.6567	25.3433
250	240.3783	9.6217
400	391.6583	8.3417
400	421.1641	-21.1641

**DURBIN-WATSON = 1.4953**

**AUTOCORRELATIONS**  
-----

LAG	A.C.F.
1	.1522
2	-.367
3	-.3906

**CORRELATION COEFFICIENTS**  
\*\*\*\*\*  
**INDEPENDENT VARIABLES LISTED IN ORDER**

X1/X2 R = -.3375

**FOURIER ANALYSIS FORECASTER**  
(CP/M and IBM only)

**INTRODUCTION**

FOURIER ANALYSIS FORECASTER (FAF) has been under development by DYNACOMP for quite some time. For years, people interested in stock market forecasting, as well as analyzing other cyclic phenomena, have been using DYNACOMP's popular FOURIER ANALYZER and HARMONIC ANALYZER. From our many discussions with individuals involved in such efforts, our staff has formed a fairly clear understanding of what software tools are really required to perform the needed calculations.

*Theoretically*, ARIMA forecasting in its full implementation is capable of handling predictions involving cyclic data. However, FOURIER ANALYSIS is really more appropriate, and the ability to explicitly determine the periods of the underlying cycles is much more useful both conceptually and in relating the calculations to the real world.

Although FAF is targeted specifically at stock market analysis, the procedures used are equally well suited to cyclic data in general. It is not assumed that you understand Fourier analysis. Instead, the manual takes a very tutorial approach to presenting the ideas involved in the Fourier series and how data can be looked at in terms of sine waves. Extensive use is made of graphical examples so that you can visualize what is going on.

The software also does not assume familiarity with even much mathematics! For those interested in the coefficients which go with all the terms, the standard errors, etc., they are all provided, including displays of the fitted equations. However, you can also rely on looking at plots, or simply use the data-versus-prediction tables. Without understanding any of the mathematics you can employ FAF to automatically do a very sophisticated analysis, predict future values, and give you an estimate of the certainty (the range) of the prediction!

In short, through years of product research, DYNACOMP has determined both the need as well as evaluated the skill level of the potential user. It then took more than a year to prepare the product.

**HOW IT WORKS**

First you enter your data from keyboard or from a disk file, save it, add to it, edit it, delete it, etc. That sounds trivial, but it sure helps to have a convenient way to enter, save, and recall your data.

The basic assumption is that the data to be analyzed can be broken down into two general components: an underlying trend, and a multi-cyclic pattern. The types of trends which can be fitted are:

Polynomial (linear, quadratic, or cubic) in time (T) or inverse time (1/T) trends

Exponentially increasing/decreasing trends (single, double exponential)

Logarithmic trends

These trend capabilities go far beyond what we have seen in other products and can even handle some fairly weird situations (electrical engineers can even fit Laplace transforms to spectral data!). Also, you can choose to either subtract the trend from the data, or divide by it (recommended for stocks/commodities). Once you have chosen the type of trend to be fitted (or none at all), FAF will automatically proceed to calculate the required coefficients and remove the trend from the data, report the form of the trend formula, and give the standard deviation of the fit as well as the confidence limits for the coefficients found. Then FAF automatically analyzes the de-trended data for its frequency components.

The Fourier analysis phase is completely automatic. FAF, in sequence, finds the dominant cyclic (sine wave) component, removes it from the data, and goes on to the next component (a form of STEPWISE NONLINEAR REGRESSION). Each time it calculates the standard deviation. When the sample standard deviation obtained at each step no longer decreases, the fitting ("decomposition") stops.

You are then presented with all of the information on the fit. You can plot or display the data, the fit, or both simultaneously. You can look at (plot or display) the "residuals" (differences between original data and fit; the "error" curve), and analyze the residuals if you want to. You can also project out into the future and (using the very special Monte Carlo analysis feature) even estimate the confidence of your projection! You can look at the trend curve by itself, save your plots in disk files, etc.

As you can see from this narrative, you can go through the analysis studying all the coefficients, or simply have the computer calculate to its conclusion without observing the inbetween steps. In the end, you can look at the fitted formula, tables, or plots. This covers quite a range of user experience and interest.

**SPECIFICATIONS**

Number of data points: 200 Max.  
Requires 128K of RAM for IBM, 64K for CP/M.  
Language: Compiled for speed  
Printer: Screen plots can be sent to any 80-column (or wider) printer. A printer is optional, but very useful.

Number of Drives: One  
Manual: 100 pages; includes examples, annotated sample runs, tutorial.

Technique used: Stepwise nonlinear regression by matrix iteration, Monte Carlo confidence analysis.

**TYPICAL USES**

- Stock and commodity cycle identification, forecasting.
- Sales forecasting; separating the trends from seasonal cycles; "deseasonalizing"
- Engineering analysis of mechanical impulses to determine resonant frequency and damping factor.
- Fitting general spectral data to find Laplace Transform (and thereby poles and zeroes).

Price: \$99.95 Diskette

FOURIER ANALYSIS FORECASTER also comes in an 8087 math coprocessor version. It runs six to seven times faster than the standard version, and will not work unless the 8087 chip is present.

Price: \$129.95

**MR. ASTROLOGER**  
(Apple, Commodore 64, and IBM only)

MR. ASTROLOGER is not only fun, but a little scary. (The non-believing copywriter who prepared this description ran a horoscope on himself and was quite impressed!)

MR. ASTROLOGER can:

- Do natal horoscopes.
- Analyze horoscopes.
- Answer questions about the future.
- Chart previews for day-to-day living.

For fun, you can do horoscopes for famous people and match them against what you know. If you are a believer in astrology, you will find MR. ASTROLOGER a quick and handy tool. If you are a doubter, you can test MR. ASTROLOGER's analyses against what you know; perhaps you'll be surprised!

Price: \$29.95 Diskette

**MARKET MODEL**  
(IBM only)

MARKET MODEL is a market simulation model for organizing information about a brand/product and its competition, and then estimating the probable effects of various marketing strategies on market share and volume. It can save you hundreds of times its price (or more!).

Marketing people are always facing questions of how price, advertising, quality, distribution, new launches, product mix, competitor action, etc., affect market share and volume. Definitive answers to these kinds of "what-if" questions are not available, and the best "real world" estimates are only possible through carefully controlled experimentation in test markets. Such experimentation can be both costly and time consuming. And there are still severe limits on how many factors in the marketing mix that can be examined simultaneously. However, a rough examination of various scenarios can be made through computer simulation.

While financial planning models and spreadsheet overlays for microcomputers are plentiful, these models do not provide estimates (forecasts) of demand ... they merely estimate the financial consequences of different demand levels.

MARKET MODEL fills this gap by providing a model based on competitive market dynamics which relates marketing mix decisions to demand as expressed by share and volume. Data from syndicated services (SAMI, NFI, LNA), internal data sources, and expert judgment are used as initial input for fitting the model to a particular market. Once the existing market has been replicated to satisfactory tolerances, MARKET MODEL can then be used to run "what-if" simulation experiments.

Although the model provides the flexibility for customization (it's not just a set of fixed-parameter equations), it's easy to work with and does not require the degree of sophistication that's necessary to build an econometric model from scratch.

Over ten years of "hands-on" consulting experience with new and existing products in all kinds of categories are incorporated in the model, so, in a sense, MARKET MODEL is a marketing strategy "expert system". As a result, you don't have to worry about what kinds of variables to include or how to put these variables together to capture the dynamics of your market. While these matters are taken care of by MARKET MODEL, you still need to expend some effort in planning your project, gathering your data, fitting the model to this data, and interpreting the results. However, you don't have to be an econometrician in order to do this.

The net benefit is that you spend relatively little time to build a custom model, and can thus concentrate most of your time on running simulations and getting feedback on alternate strategic policies. The advantages of being able to "bench test" strategies prior to major commitments of time and money are obvious.

Fitting the model and running simulations can also provide interesting insights about implicit assumptions regarding "what makes the market tick", and how these assumptions hold up when the available information is examined objectively.

Among the many features are:

- Variables included for each product: Advertising expenditure
- Advertising effectiveness index
- Product quality index
- Price per equivalent unit
- Distribution/point-of-purchase index
- Unit share in previous time period
- Unit share in current time period (used only to obtain initial fit)

- Simulation estimates: Unit share, Unit volume, Dollar share, Dollar volume
- Goodness-of-fit calculations for actual vs. estimate are optionally performed along with the generation of suggested parameter weights.
- Parameters and data can be "fine tuned" interactively.
- Menu-driven; no commands to remember.
- Data is entered and edited using a spreadsheet-like environment.
- Logical design, range checking, and error trapping to minimize mistakes and allow easy recovery from errors.
- Comprehensive manual takes you in easy-to-digest steps through all features.

Requires at least 64K of RAM, one disk drive, and an 80-column (or wider) printer.

Price: \$249.95 Diskette

**HANDLOADER'S TOOL KIT**  
(Apple only)

HANDLOADER'S TOOL KIT is an accurate program for determining the optimum load and complete ballistics for almost any firearm. Based on a small amount of input data, you can select the correct powder type (or types) and powder charge, and calculate the estimated muzzle velocity and chamber pressure.

Once cartridge loading data have been established, you may compute the complete ballistics for the cartridge—including muzzle energy, terminal velocity, terminal energy, time of bullet flight, bullet wind drift, and bullet drop for any range. In addition, you may display a complete trajectory table, showing bullet height in relation to line of sight for any range selected. This can be done for any cartridge for which the muzzle velocity, bullet weight, and bullet ballistic coefficient are known.

You may average velocities (or bullet weights, or almost any set of numbers) and find the standard deviation, max. and min. values, and spread.

If you wish to brush up on the fundamentals of interior and exterior ballistics, a section on ballistics is also included in the instruction manual.

You can also study the effect of barrel length (or the effect of bullet weight and bullet seating depth) on velocity, or determine the performance and ballistics of a new or wildcat cartridge without firing a shot. This last feature alone could be worth many times the cost of the program.

HANDLOADER'S TOOL KIT is menu-driven for ease of use. It is a must for every serious shooter!

Requires 48K, and one disk drive. A printer is supported.

Price: \$79.95 Diskette

**Excerpt from a Review of HANDLOADER'S TOOL KIT**  
(Guns and Ammo, Sept. 1985, by John Wootters)

"The wildcatters will drool over [The Handloader's Tool-kit]! With it and a home computer, they can let their imaginations run riot, designing and 'testing' nonexistent cartridges to their hearts' content.

"I like [the program] very much and believe every serious reloader with an Apple II+, IIc or IIe will find it equally fascinating."

**RELOADING DATABASE**  
(CP/M and IBM only)

RELOADING DATABASE is an integrated hand-loading analysis package. It features:

1. Reloading data storage and retrieval.
2. Creates work sheets and load identification slips for use in recording test data.
3. Computes accuracy and velocity statistics and recoil and trajectory parameters of test loads.
4. Creates reports sorted by velocity and accuracy.
5. Creates bar graphs with data sorted by components and accuracy.
6. Reproduces target for future reference.
7. Provides flexibility to make maximum use of available hardware features with built-in configuration dialog.
8. Provides simple user interface minimizing entry of duplicate data.
9. Includes an excellent 73-page manual.

The printed reports require a 132-column or wider printer. Printed graphs require an IBM or Epson compatible printer.

Price: \$99.95

**HAVE YOU THOUGHT ABOUT . . .**

our low prices on disks, diskettes, and cassettes! They're a real bargain — a nice gift for a computerist friend, too.

**COMPUTRONICS MASTER PAC 100**  
(TRS-80, Apple, and IBM only)

This is one of the two "100" software packages which you have probably seen advertised in *BYTE*, *Creative Computing*, etc. It was originally sold by Computronics. However, through a reciprocity agreement, it is now also available through DYNACOMP, and at a discount. Here is a partial list of the programs:

**Business & Personal Finance**

- RATE OF RETURN-VARIABLE INFLOW
- RATE OF RETURN-CONSTANT INFLOW
- REGULAR WITHDRAWAL FROM INVESTMENT
- STRAIGHT LINE DEPRECIATION
- SUM OF DIGITS DEPRECIATION
- DECLINING BALANCE DEPRECIATION
- BREAK EVEN ANALYSIS

**Statistics and Mathematics**

- ROOTS OF POLYNOMIALS
- ROOTS-NEWTON'S METHOD
- PRIME FACTORS OF INTEGER
- LAST COMMON DENOMINATOR
- RADIAN-DEGREE CONVERSION
- NUMERICAL INTEGRATION

**Utilities**

- QUICK SORT ROUTINE
- PROGRAM STORAGE INDEX
- MULTIPLE CHOICE QUIZ BUILDER
- FORM LETTER WRITER
- SHELL SORT

**Gambling and Games**

- STATE CAPITAL QUIZ
- TIC-TAC-TOE
- DICE GAME
- LUNAR LANDER GAME
- BIORHYTHM

Included is a 110 page manual. All programs are written in BASIC.

Sample printed displays:

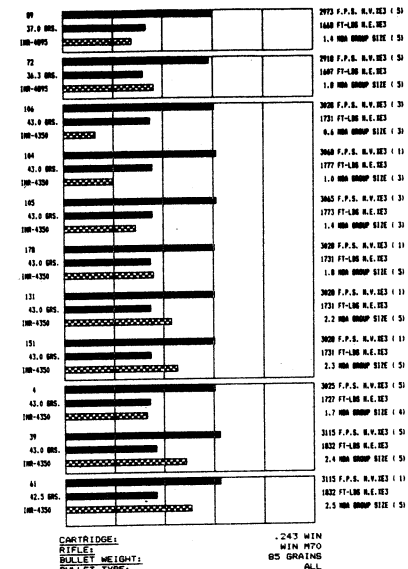

LOAD NUMBER: 3 GROUP SIZE: 2.84 MOA

**FOR THE BEST PRICES ON EXCELLENT QUALITY DISKETTES, SEE OUR SUPPLIES SECTION. WE DO NOT SELL THE REJECTS, SECONDS, OR REDUCED SPECIFICATION DISKETTES WHICH ARE NOW BEING SOLD AT "AMAZINGLY" LOW PRICES. THEY ARE NOT SO AMAZING IN QUALITY!**

System	List Price	DYNACOMP's Price
TRS-80, Apple Diskettes	\$ 99.95	\$ 89.95
5 1/4" CP/M, IBM Diskettes	\$149.95	\$129.95
8" CP/M Disk	\$149.95	\$129.95

**TANKCALC**  
(IBM only)

TANKCALC is the perfect tool to assist in liquids inventory control. It creates operating tank calibration (gauging) tables quickly, easily, and accurately. TANKCALC is well documented and has a variety of applications including: determining tank contents available for use, performing what-if analysis for tank design, checking hand-calculated charts, and calibrating storage tanks. Horizontal cylindrical tanks can be level or sloped with a variety of head shapes.

Selection menus and question-and-answer screens guide you. Once a tank shape has been chosen, data for creating the chart is entered. From a menu of seven activities, you choose to enter data for a new chart, save tank data on disk, retrieve data, review data, print a calibration table, or develop other cases for the same tank. Question-and-answer prompts ensure the accurate entry of all information including: units of measure, tank dimensions, and density (or specific gravity).

A clear and comprehensive user's manual (over 100 pages) accompanies the software. It contains an extensive chapter on tank information, including the required physical dimension inputs and drawings. Instructions, examples, and screen illustrations are given for each option and each step in the program.

Use TANKCALC for:

- Computer aided design
- Tank inventory determination
- End-of-shift reports
- End-of-month accounting
- Checking hand-calculated charts
- Tank gauging "Customer Service"

Features:

- Uses English or Metric units.
- Calibrates by volume (cubic feet, gallons, liters, or cubic meters).
- Calibrates by weight (pounds or kilograms).
- Handles inputs of specific gravity or bulk density.
- TANKCALC is fast and easy to use.

Standard tank shapes:

## Vertical Cylindrical Tanks

- Level flat bottom
- Sloped flat bottom
- Hemispherical bottom
- Cone bottom

## Horizontal Cylindrical Tanks

- Flat heads
- Hemispherical heads
- 2:1 Elliptical heads
- Dished heads\*

## Spherical Tanks

- Square or Rectangular Tanks
- Level flat bottom
- Sloped flat bottom
- Pyramid bottom

TANKCALC requires PC-DOS or MS-DOS 2.0 or higher and 128K of RAM as well as an 80-column printer and one 360K disk drive.

Price: \$395.00 Three Diskettes

\* Head and sloped-vessel calculations follow the American Petroleum Institute Standard 2551.

**FOR THE BEST PRICES ON EXCELLENT QUALITY DISKETTES, SEE OUR SUPPLIES SECTION. WE DO NOT SELL THE REJECTS, SECONDS, OR REDUCED SPECIFICATION DISKETTES WHICH ARE NOW BEING SOLD AT "AMAZINGLY" LOW PRICES. THEY ARE NOT SO AMAZING IN QUALITY!**

**PHYSICAL PROPERTIES OF HYDROCARBON LIQUIDS**

(Apple only)

For the first time, the chemical or petroleum engineer has at his fingertips the ability to calculate quickly the important physical properties of liquid hydrocarbons, including viscosity, gravity, and thermal conductivity. Charts, graphs, tables, log-log plots, and tedious hand calculations are now replaced by a few simple keystrokes on the computer keyboard. This is the only software package on the market that will predict reasonable viscosities for cold crude oil and residuum streams.

LIQUID HYDROCARBONS is divided into three sections, with each section covering a different property.

The viscosity vs. temperature portion of the program uses equations presented in ASTM-D-341, while correlations for the viscosity of petroleum blends were obtained from curve-fitting of the blending indices that appear in Maxwell. Correlations for calculating viscosity from K and API data were obtained by curve fitting of data from the API Data Book, TEMA, and the author's files.

Specific gravity correlations were obtained by curve fitting of data that appear in Cameron. Hydrocarbon liquid thermal conductivities were obtained by curve fitting of data that appear in Kern.

All portions of the program are menu-driven, allowing easy access by even the first-time user with only a minimum of instructions. All calculated results can be routed to a printer for hard copy.

Requires 48K. Printer optional.

Price: \$49.95 Diskette

**TWO-PHASE PRESSURE DROP IN PROCESS PIPING**

(Apple only)

TPPD allows the design engineer to quickly and easily calculate pressure drops in process piping for either single-phase or two-phase flow. You may choose either the popular Ovid Baker or A. E. Dukler methods for horizontal pipes, or the widely acclaimed Orkiszewski method for vertical pipes. For single-phase flow of liquid or non-compressible gas flow, the pressure drop is calculated by the familiar Darcy equation.

TPPD is menu driven, providing flexibility while allowing easy access by either the experienced computer user or novice. A multilevel menu structure allows you to quickly study "what-ifs" for a wide range of pipe sizes or to change part or all of the input data and study the effect of flow rates or physical property data on pressure drop for just about any system. Charts and graphs are not required.

With a minimum of input data, you can quickly calculate the pressure drop for a given nominal pipe size and schedule; the pipe size for a given pressure drop; the pressure drop for a range of pipe sizes; or the pressure drop for a given pipe diameter. Immediate results, along with a summary of calculated results and input data, are displayed on the screen and can be printed. Detailed calculations can also be reviewed or printed.

TPPD covers most common pipe sizes from 2 to 20 inches and pipe schedules of 10, 40, 80, and 160. Values falling outside this range can be readily calculated by entering the actual inside-diameter of the pipe.

Requires 48K of RAM and one disk drive. A printer is supported, but optional.

Price: \$49.95 Diskette

**MODERN PHYSICS SERIES PHYSICAL CHEMISTRY I**

(Kaypro only)

This package consists of two main programs, SWELL and THERMO, and a graphics utility named DISPLAY. These programs may be used on any Kaypro 10, as well as on the Kaypro 2 and Kaypro 4 models with the same graphics capabilities (Kaypro 2-84 and 4-84). They cannot be used on the older Kaypro 2 and Kaypro 4 models without graphics capabilities.

SWELL and THERMO illustrate aspects of quantum mechanics and statistical mechanics.

SWELL calculates and displays the energy levels and wave functions of an electron bound in a potential function known as a square well. This topic may be covered in college-level chemistry or physics courses on physical chemistry, spectroscopy, quantum chemistry, or quantum mechanics.

You may specify the width of the attractive region in Angstroms, and the depth of the well in electron volts. Based on this, SWELL calculates the number of bound quantum states, the energy eigenvalue for each bound state, and the corresponding wave functions. SWELL displays each energy eigenvalue as a horizontal line superimposed on the potential energy function. Each of the wave functions is also displayed, superimposed on the corresponding energy levels.

The wave functions displayed illustrate the phenomenon of tunnelling. SWELL may also be used to

demonstrate the solutions to the particle-in-a-box problem by selecting a very large depth. A set of exercises is included with the documentation.

Images produced by SWELL may be stored in a disk file. They may be displayed on the screen by using the DISPLAY utility. They may also be printed on an Epson FX-80 or compatible dot-matrix printer, or plotted on a Tektronix 4662 or compatible plotter using programs in MOLECULAR MODELLING (listed elsewhere).

THERMO demonstrates how a collection of atoms or molecules may be distributed among a set of energy levels, and how this distribution depends on the spacing of the energy levels and the temperature. This topic is usually covered in college-level courses on physical chemistry, thermodynamics, and statistical mechanics.

THERMO allows you to specify an arbitrary set of energy levels and the degeneracy of each energy level. The energies may be specified in kJ/mole, kcal/mole, electron volts, or Hartrees. One may specify a temperature in Kelvin, Celsius, or Fahrenheit scales. Based on this information, THERMO calculates the partition function for the energy levels, and the population of each level. The energy levels are displayed as short horizontal lines, and the populations are displayed as a horizontal bar chart.

Exercises provided with THERMO describe how to represent the properties of a harmonic oscillator, a rigid rotor, and chemical equilibrium.

Price: \$39.95 Diskette

**MOLECULAR MODELLING**

(Kaypro only)

MOLECULAR MODELLING is an integrated system of programs for creating images of molecules. Four basic types of images may be created:

1. Stick models (straight lines between nuclei).
2. Bond models (short straight lines between atomic symbols).
3. Space-filling models (outlines and seams).
4. Space-filling models (filled surfaces).

The images of space-filling models represent each atom as a true sphere, and include the seams where any two spherical-atoms intersect. In addition, it is possible to cover the surface of each atom with lines to further enhance the spherical rather than disk-like shape of each atom.

The only data required to create an image of a molecule are the symbols of atoms and the positions of the bonds connecting the atoms. It is not necessary to enter any numerical data such as atomic coordinates, bond lengths, or bond angles. Based on the atomic symbols and positions of the bonds, MOLECULAR MODELLING can determine an approximate structure for a molecule with up to 100 atoms. The resulting structure is usually qualitatively realistic, although not highly accurate. The molecular geometry calculated by MOLECULAR MODELLING may be replaced with more accurate atomic coordinates if the appropriate data are available. In addition, it is possible to add hydrogen atoms to a skeletal structure.

After the structure of a molecule has been specified or calculated, the structure may be rotated about the x, y, and z axes. It is also possible to display the distance between any pairs of atoms, the angle formed by any set of three atoms, and the dihedral angle formed by any set of four atoms.

MOLECULAR MODELLING should be most useful to teachers, students, scientists, and research associates in many areas of chemistry. The images of molecules created by this system may be used to illustrate lecture

notes and research publications. Individuals involved in marketing chemicals, pharmaceuticals, or other products may use these images to illustrate sales literature and advertising materials. The molecular structures determined by MOLECULAR MODELLING may provide a convenient starting point for more elaborate methods for calculating molecular geometries and properties, such as molecular mechanics calculations and molecular orbital or quantum chemical calculations.

MOLECULAR MODELLING may be operated on a Kaypro 10, or any Kaypro 2 or Kaypro 4 with the same graphics capabilities as the Kaypro 10 (1984 or newer Kaypros). Low-resolution images of molecules may be displayed directly on the screen on any of these computers. It is also possible to save these images in high-resolution vector files on a floppy diskette or hard disk. An image stored in a vector file may be enlarged, reduced, or clipped. MOLECULAR MODELLING can print hard-copy images on any of these devices:

1. Tektronix 4662 (or compatible) plotters
2. Epson FX-80 (or compatible) dot-matrix printers
3. Radio Shack DMP-100 (or compatible) dot-matrix printers.

At last, mainframe modelling capability on a micro!

Price: \$99.95 Two Diskettes

Sample display (Epson):

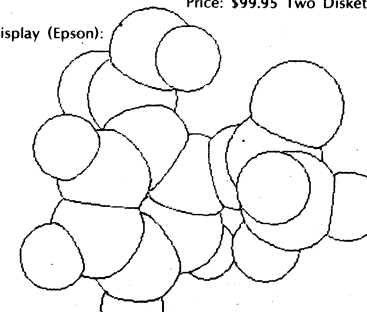

**SYRSOL ENERGY ANALYZER™**

(IBM only)

SYRSOL is a comprehensive and flexible tool for the energy design, analysis, and simulation of new and existing buildings of all types and sizes. It calculates heating and cooling loads, energy consumption, and operating costs. It uses a dynamic hourly calculation model based on ASHRAE (American Society of Heating, Air Conditioning, and Refrigeration Engineers) methods for realistic results. The model includes such factors as building shell, lighting, infiltration, ventilation, occupancy, solar gains, thermal storage, heating and cooling equipment, and operating schedules. It performs a detailed hour-by-hour, zone-by-zone analysis.

Developed on IBM 370 and 4341 mainframes over a period of 12 years, SYRSOL is a powerful program which has been well tested in the user environment.

No previous experience with a computer is required. SYRSOL was designed for busy professionals, not for programmers.

You prepare the input data files in a completely interactive manner. You need not know anything about the format or the order of the input data. The input query goes through every variable, displays its current value, and asks you if you wish to change it. You may change it or just press the <ENTER> key to get the next variable. The values displayed are read from a reference file that you specify and can modify for "what-if" analysis.

The simulation module performs all of the calculations. For every hour of the day, it goes through every zone, every surface, and every load, and determines the hourly heat losses and heat gains. It also calculates the hourly energy consumption and operating costs.

SYRSOL can handle structures of unlimited size with 80 surfaces and four zones. The software automatically uses the 8087 math chip if it is present.

Included is a weather database for over 200 cities (You may add to this.). This database is accessed automatically by the program.

Here are some of the simulation and report features:

- Detailed energy use and power bill reports (hourly/daily/monthly/total)
- Building energy-performance analysis
- Perturbation studies
- Flexible operating schedules and capacities for occupancy, lighting, ventilation, and equipment
- Flexible weekend/day schedule
- Decentralized modular heating and cooling systems
- Centralized heating and cooling systems
- Simultaneous heating and cooling in different zones
- Internal heat gains
- Part-load and full-load equipment efficiencies
- Solar gain from windows, skylights, walls, roofs
- Shading of windows by overhangs and recesses
- Energy conservation features
- Hour-by-hour lighting control, basic daylighting
- Insulated night shutters
- Thermal storage for waste and solar heat
- Five active solar models: flat-plate and tracking
- Powerful passive solar heating model
- Three water-to-water and air-to-air heat pump models
- Three domestic hot water models with heat pumps
- Two domestic hot water models with heat exchangers
- Model for heat loss from hot-water pipes
- Ventilation heat recovery
- Evaporative cooling in hot climates
- Rotate the building by changing a single variable
- Variable ground reflectance (snow, reflectors)
- Time-of-day and time-of-year electric rates
- Electric demand charges
- Simulate 1, 2, 3, 4, ... 30 (or 31 or 28) days a month

**SYRSOL SUN SOURCE™  
SOLAR DATA GENERATOR**

(IBM only)

SUN SOURCE is identical with the SYRSOL ENERGY ANALYZER in every sense, with the exception that the SUN SOURCE deals with a single surface only.

The system requirements for SUN SOURCE are the same as for SYRSOL. Both packages have the same ease of use, and same quality, type, and appearance of output reports. They use the same weather database.

SUN SOURCE can produce more solar data than all the textbooks and handbooks in a respectable library.

SUN SOURCE can predict solar data for any surface of any tilt and any azimuth angle anywhere in the northern hemisphere.

For every hour, every day, and every month of a full year, the SUN SOURCE can compute the following:

- Total (direct+diffuse+reflected) insolation
- Direct insolation
- Direct normal insolation
- Diffuse insolation
- Reflected insolation
- Solar altitude angle
- Solar azimuth angle
- Solar incidence angle

SUN SOURCE produces complete and self-documenting tabular and graphical reports giving hourly values; half-day, full-day, and monthly totals.

See SYRSOL ENERGY ANALYZER for requirements.

Price: \$99.95 Diskette

**SYRSOL DEMONSTRATOR**

(IBM only)

A demonstration disk, including the full SYRSOL ENERGY and SUN SOURCE manuals, is available for \$49.95. This demonstration is not returnable, but may be applied toward the purchase of either package.

Evaluation kits are not refundable.

**HINT**  
(CP/M)

FILE NOT FOUND. Simply put, the computer cannot find the file you named. Did you use CAPITALS? Although some machines allow lower case letters, it does not always work. Check the directory for the right name.

- Control logic routines for energy efficiency
- Full or partial systems shutdown when unoccupied
- A sophisticated thermostat
- Hourly heat and moisture balance for each zone
- Eleven surface types: basements, slabs, partitions, etc.
- Skylights and windows of any tilt, azimuth, glazing
- Multiple fuels: natural gas, fuel oil, LPG, etc.
- Boilers, furnaces, resistance heaters, wood stoves
- Movable window shading in the cooling mode
- Tabular and graphic output
- Switch between English and metric units instantly
- Automatic data backup procedures

Requires 160K of RAM, PC or MS DOS 2.0 or higher. Any 80-column or wider printer is supported (if printed reports are desired). BASIC is not needed (software is compiled for speed).

Price: \$199.95 Two Diskettes

**HEAT LOSS**

(Atari, Apple, and CP/M only)

HEAT LOSS uses ASHRAE (American Society of Heating, Refrigeration, and Air Conditioning Engineers) methods to calculate the heat losses through various parts of a building: roof, walls, doors, etc. Window, door, and lower areas are automatically subtracted from wall areas, and the heat loss for each element is calculated and summed for room and building totals. Room infiltration and ventilation loads are also calculated, along with the overall building heat-loss coefficients required by some state energy codes.

HEAT LOSS is intended to be used by heating design engineers, building contractors, architects and engineering students. While most aspects of the design process are explained, additional information from a source such as the ASHRAE "Handbook of Fundamentals" would be required for actual design work. For example, "R" values are needed.

HEAT LOSS provides for storing and retrieving data, reviewing and changing of individual rooms or room elements, and printing out results. It will handle up to two hundred rooms on a 48K machine. Printer output is very general — all 40-column and 80-column printers will work.

Requires at least 32K.

Price: \$39.95 Diskette  
\$42.45 8" CP/M Disk

NOTE: CP/M version requires an 8080, 8085 or Z80 microprocessor. MBASIC not required.

**SOFNET**

(CP/M, IBM, TRS-80, and Apple only)

Liquid Pipeline Network Analysis

Apple description; TRS and others very similar.

SOFNET is a general purpose liquid pipeline network analysis program designed for the Apple personal computer system. It is written in APPLESOFT BASIC with machine-language subroutines for greater speed. The hardware requirements include a minimum of 48K memory, one disk drive, and an optional 80-column printer for permanent copy.

SOFNET is a powerful modeling tool for system planning and analysis which lets you tackle virtually any type of network configuration. Network data files may be created, edited, and stored on diskette using the Apple's built-in APPLESOFT editing features. When executed, the input data file is interactively requested by the system. An internal data checker searches for data errors and omissions. Once verified, the program indexes all nodes and associated connectors and solves the series of flow

**ROOTS**

(available for all computers)

If you want to determine the zeroes of a polynomial having real coefficients, ROOTS is the program for the task. ROOTS employs a relatively little known algorithm described in the computer mathematics literature several years ago. This algorithm iteratively seeks all the roots simultaneously. The convergence is cubic (and therefore rapid) and very stable, requiring no explicit initial guesses from the user. Accuracy is usually within two digits of the precision of the BASIC employed. In addition to displaying the calculated solutions, the program also shows the results of substituting those values into the original polynomial. Convergence failure is highly unlikely and, if it occurs, it is generally limited to special multiple (M-2) roots. Any order polynomial may be treated.

Price: \$15.95 Cassette  
\$19.95 Diskette  
\$22.45 8" CP/M Disk

Sample display (Apple)

**SOLAR HEAT GAIN**

(Apple and Commodore 64 only)

SOLAR HEAT GAIN is intended to be used as a design tool for anyone interested in the effects of the sun on the heating and cooling of buildings.

SOLAR HEAT GAIN has five options. The *insolation* option calculates gain through unshaded glazing. The *overhang* option calculates gain through a window or windows shaded by an overhang. The *shading* option calculates gain through a window shaded by a wall on one side of the window, by walls on both sides of the window, or by a wall or walls in combination with an overhang. The *egg-crate* option calculates gain through a deeply recessed window or through a window shaded by an egg-crate shading device. The *external shading* option determines whether an object such as a tree or wall is shading the wall of a building.

You enter specific information which is explained in detail in the manual. The program displays the information entered on the screen so that you can check it for mistakes. If correct, the calculations are made and displayed on the screen.

Examples are given for the insolation and overhang options which show how they are used. A section that gives some tips on designing shading devices is also included.

Price: \$49.95 Diskette

**CALFEX and CALFEX G/T**  
(Apple and IBM)

Forget your calculator, CALFEX and CALFEX G/T are here! They form a general-purpose menu-driven equation processor for engineering and scientific analysis. Now you can do calculations that used to take hours in only minutes. CALFEX does for engineers what the popular spreadsheet programs do for businessmen. You provide the equations and CALFEX does the rest. Labels or names for variables are easily included. Up to 10 sets of values for the independent variables can be saved.

From the menu page showing all the inputs, any value may be easily changed by moving the cursor. One keystroke then displays all the calculated answers. The powerful Variable Exchange feature lets you force an answer to a given value by varying any input, without rewriting anything. It uses an iteration process that also lets you solve for variables which are difficult or impossible to solve for analytically. For example, you might specify the values of certain dependent variables to determine the independent variable (specify deflection and find force).

**ADDITIONAL FEATURES:**

- Graphs and Tables: CALFEX G/T contains built-in graphics to allow plots of your results with a minimum of effort. Includes autoscaling if desired and tables of values for the plotted points. You can also plot up to 3 lines on a graph by letting a third variable take on 3 distinct values. Works with any printer. Choice of linear, log, or semilog plots.
- Maxima and Minima. Can be found automatically.
- Simultaneous equations. Up to 10.
- Numerical Integration.
- Array or Simple Variables. Up to 120 inputs and 120 outputs.
- Access to BASIC. Normally you just add your equations but, if needed, you have full access to BASIC programming, including reading or saving data files, adding your special programming, etc.
- Organized and Documented Programs. Other users can now follow your programs.

CALFEX is easy to learn, even if you have never used a personal computer. It is extremely useful for design optimization modeling. CALFEX is supplied with a thorough manual and demos. Also included is CALFEX G/T which is described as follows.

CALFEX G/T expands the capabilities of the basic CALFEX program. With graphs you can easily see the general trend of how one variable depends on another. Then you can get a table of the exact values for all the plotted points if desired. If, for example, you are trying to optimize a design, the graph shows the trend and the table gives the values so you can quickly get a feel for how the variables interact. The CALFEX G/T package speeds up the process of finding useful solutions to your problems.

- **EASY TO USE:** The graph is automatically scaled and labeled with a minimum number of inputs from you. The whole program is designed for ease of use.
- **LINEAR, LOG, OR SEMILOG PLOTS** are easily created by simply choosing the scale for each axis.
- **PRINTS TABLES OF THE RESULTS:** In addition to graphs, you can now get tables of results so you can see exactly how variables interact. The table will list the exact values of plotted points.
- **PARAMETRIC GRAPHS:** You can let a third variable take on three different values and plot the three curves on one graph.

Requires 48K (Apple), 96K (IBM).

Price: \$289.95 Diskette  
(CALFEX and CALFEX G/T package)

**Sample Printouts:**

```

UDP NAME: TRAJECTORY/4/4/S
INPUT SET #: 1

V Y3-
E R L:
T I!
. N!
. E!
. A!
P R!
O S Y2-
I I!
T V!
I I!
O M!
N Z!
' !
F !
T Y1-
-----
X1          V:AO X2          LINEAR X3
          HORIZ. POSITION, FT
Y3=5000          X3=30000
Y2=2500          X2=15000
Y1=0             X1=0
    
```

**Sample variable exchange problem:**

$$X = \frac{aY^4 + Y \cos(Y + Z)}{1 - bY^2 \log(Z/Y)}$$

You can solve for X, Y, or Z given the other two.

**PIPELINE PRESSURE LOSS**

(Atari, CP/M, and IBM only)

PRESSURE LOSS calculates the pressure head loss in simple piping systems, such as found in plumbing and heating. The longest path (greatest resistance) is selected, and the corresponding head loss calculated. This gives the greatest head a pump has to deliver to supply the demand.

In operation you select the material (copper, PVC, or schedule-40 steel) and the max/min unit head loss (default is the ASHRAE recommended 100-500 millinches/ft.). You also supply the initial flow, the number of elbows, gates, globe and check valves, line flow and branch flow tee's. The program then determines the proper pipe diameter, calculates the unit head loss and total loss.

At the beginning of each segment you can add or delete from the flow, or specify a direct loss (e.g., the rated drop through a coil). The program uses data from ASHRAE charts and employs the system head curve relationship to determine the loss for trial pipe diameters until a loss in the specified range is found.

The program is accurate in the loss range of 100-500 millinches/ft., and can be used outside that range with less accuracy.

Requires 48K.

Price: \$39.95 Diskette  
\$42.45 8" CP/M Disk

**MECHANICAL ENGINEERING #1**

(Apple and IBM)

A collection of programs for use with CALFEX

This is a collection of mechanical engineering programs for use with the general purpose analysis program, CALFEX.

These programs can save you considerable time and effort in analyzing problems. They are truly a bargain on a cost-per-program basis and, since all utilize the basic CALFEX program, the format is uniform and easily understood. The programs are a valuable addition to any mechanical engineer's library.

These programs were written by professional engineers for real-world problem solving and design optimizing. Some of the solutions presented here will not be found elsewhere. Most are adapted from well known problems. They are sufficiently documented so that you can check the underlying theory if necessary, or alter it to suit special purposes. All are written in BASIC and program printouts are included to facilitate detailed review.

All allow the powerful Exchange Variable option, so you can interchange a dependent variable for an independent variable to reverse their roles.

**CONTENTS**

**Applied Math**  
FOURIER SERIES for up to 59 pairs of input values, resulting in up to 59 coefficients of sine and cosine terms. A second program does the same job and, in addition, calculates how well the resulting Fourier Series fits the given data.

**Stress and Strain**  
BEAMS WITH TRAVERSE LOADS: This program contains all the 6 combinations of simple beam-end conditions and 7 kinds of traverse loads, moments, and imposed distortions of Table 3 of *Formulas for Stress and Strain*, 5th Edition, Roark and Young (McGraw-Hill Book Co.). Up to 37 individual loads, moments, and distortions at 37 locations may be simultaneously imposed and the programs up to the result. The CALFEX exchange variable feature allows maxima and minima to be found for stress, moment, deflection, etc.

HELICAL SPRINGS, GENERAL: This program calculates axial, torsional, and lateral bending stiffness and resonant frequencies, along with the usual spring parameters, for round or rectangular wire. Some of these results have not been previously available. In particular, buckling loads are calculated by a more complete theory than has been generally used.

HELICAL SPRINGS, SIMPLE: This is similar to the above but omits a number of the more usual outputs. It runs faster and is a little easier to use, when it is adequate.

HELICAL SPRINGS, NONLINEAR: This follows the special theory reviewed on pages 320 and 321 of the Roark and Young book, giving a more precise relation between load and axial displacement.

BEAMS WITH END LOADS AND SIDE LOADS: This is capable of almost exactly the same results as Beams With Traverse Loads but with end loads of tension or compression. It contains the essential parts of tables 10 and 11 of the Roark and Young book for all 6 beam types. For any one end load, up to 55 traverse loads can be applied, and the results are summed up.

**Fluid Flow**  
DUCT FLOW calculates pressure drop, mean velocity, Reynold's Number, etc., for incompressible flow for round or rectangular ducts or pipes. For air and water, viscosity and density are calculated automatically if you enter the temperature and pressure. Roughness is one of the inputs.

**Dynamics**  
DISK-SHAFT VIBRATIONS: Resonant frequencies are computed for a system of disks and shafts, for as few as 2 disks and 1 connecting shaft or as many as 59 disks and 58 shafts. For a given driving frequency and amplitude on one end, the amplitudes of response of each disk may also be determined.

IBM version requires 96K; Apple version requires 48K. Needs CALFEX to operate.

Price: \$199.95 Diskette

**SECTION PROPERTIES**

(Atari version)

Structural/mechanical design and stress analysis often requires calculation of the strength and stiffness properties of various structural cross sections to determine the capability of the sections to withstand axial, bending or torsional loads. SECTION PROPERTIES greatly speeds and simplifies the task of determining these properties, particularly for complicated or irregular sections.

This program is entirely menu driven and self prompting, with extensive error trapping and correcting to help prevent the necessity of restarts. The sections are presented graphically on the screen to increase usability and reduce the possibility of incorrectly defined shapes.

SECTION PROPERTIES provides solutions for cross section area, location of section centroid, moment of inertia, section modulus, radius of gyration, product of inertia, polar moment of inertia, principal major and minor moments of inertia and the angle of the principal major axis. Printer options allow the user to obtain a printer trace of the input data, a screen dump of the plotted section or a hard copy of the results. Includes 45 page manual. Requires 24K (cassette) or 32K (disk). Printer optional.

Price: \$39.95 Cassette  
\$43.95 Diskette

**SECTION PROPERTIES**

(TRS-80, CP/M, and IBM only)

SECTION PROPERTIES will calculate mechanical properties for virtually any structural cross section. You may determine the area, centroids, moments of inertia, section moduli, and radii of gyration about two given perpendicular axes of the section. You may also evaluate the angle of the principal axes, moments of inertia, and radii of gyration about the two principal axes. Output values may be recorded from the screen or listed on a printer.

The cross section may be composed of rectangles, radial segments, and special sections with known properties, with a limit of 20 of each type. Rectangles may be oriented at any angle. Radial segments may be a solid bar, a circular sector, a round tube, or a shell segment. Special sections may be any for which the properties are known, including all the standard rolled sections given in the steel manuals.

SECTION PROPERTIES is an interactive program with menus for options and screen prompts for data entries. It was designed to be "user friendly" with screen help information, editing, and data backup features. Section input data may be stored for later editing and use.

Requires at least 48K of RAM. A printer is supported, but optional. Includes a 30-page manual.

Price: \$39.95 Diskette  
\$42.45 8-inch CP/M Disk



**ANALYSIS OF CONTINUOUS BEAMS**

(TRS-80, CP/M, and IBM only)

ANALYSIS OF CONTINUOUS BEAMS (ACB) is a program for analyzing determinate and indeterminate beam structures. It calculates joint displacements and rotations, member end shear forces, bending moments, and section top and bottom stresses. Loading may be defined by concentrated loads and moments, and member-uniform and linearly distributed loads. ACB is also capable of analyzing support settlement.

Connections between the members may be either rigid or hinged. Moments of inertia and section moduli may be different for each member. The limits are 40 members and 60 degrees of freedom. The number of load cases is not limited. Joint locations (displacements) are given not only at supports, but also at concentrated loads and moments, the start and end of member-distributed loads, and at any other location for which output results are needed.

ACB is an interactive program with screen menus for options and prompts for data input. It is designed to be "user friendly" with screen help information, editing and backup features, and minimal data preparation. You also have the option of storing the beam data for later editing and running.

ACB and DYNACOMP's BEAM DEFLECTION are quite different programs aimed at different applications, though there is some overlap.

A brief comparison is shown below:

**Capabilities in ACB not available (or limited) in BEAM DEFLECTION:**

- Bending moments can be specified at each member joint.
- Composite beams having 40 members can be defined. This allows for abrupt changes in modulus, loading, etc. BEAM DEFLECTION approximates abrupt changes.
- Much more detailed beam description.
- Hinging between members (versus pinning in BEAM DEFLECTION).
- More output stations, resolution.

**Capabilities in BEAM DEFLECTION not available in ACB:**

- Spring supports, elastic bed.
- Much less input required (e.g., degree of freedom information at each joint not required).
- Solution not by segments, but by integration over continuous beam.
- Plotting of deflection and stress.
- Stress evaluation at any specified distance from neutral axis.

The differences between ACB and BEAM DEFLECTION are largely the result of a difference in the mode of solution.

Includes a 35-page manual. A printer is supported, but is not necessary (though recommended). Requires at least 48K of RAM.

Price: \$49.95 Diskette  
\$52.45 8-inch CP/M Disk

ANALYSIS OF CONTINUOUS BEAMS and BEAM DEFLECTION may be purchased as a package for \$69.95 (diskettes), \$73.95 (8-inch CP/M Disks). Sorry, no further discounts off the package price (e.g., 10%-20% quantity discounts) are permitted.

**BEAM DEFLECTION**(Available for all computers)  
disk/diskette only

BEAM DEFLECTION is the first in DYNACOMP's new series of structural analysis software packages. It consists of two programs. The first program permits the development of data files which describe the problem. For example, the ends of the beam may be pinned, clamped or free. The beam may be uniformly supported by an elastic bed, or held up by springs variously placed and having differing spring constants. The elasticity and cross section of the beam may vary along its length. The load may be uniformly distributed or it may include discrete forces. The beam may be pinned at various points along its length. And so on. All this information may be easily entered and edited using the data input program.

Following this the analysis program is called. The calculated results are the stress and deflections of the beam, both in numerical and graphic form. Since the input data is saved, cases may be easily re-run with modification, thereby permitting iterative design.

The documentation which comes with BEAM DEFLECTION clearly shows how to use the software. In addition, three text problems are described and demonstrated to ensure that you understand how to use the program. Also, helpful theoretical information is supplied in the appendix.

Price: \$39.95 Diskette  
\$42.45 Disk

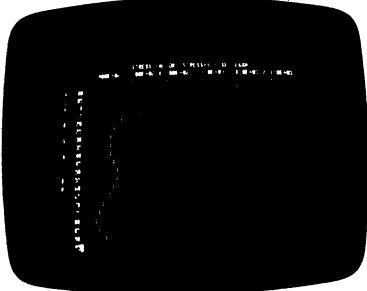
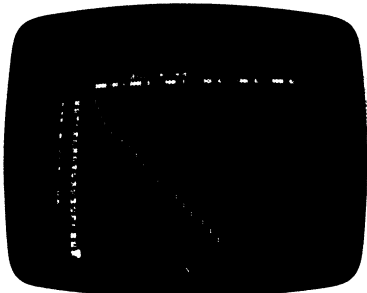
**BEAM DEFLECTION NOTICE**

If you have received your copy of BEAM DEFLECTION prior to June 15, 1984, please note that some improvements have been made to the interpolation routine. You may obtain an updated copy by returning your original DYNACOMP diskette with a check (or MasterCard/Visa number) for \$5.00 to cover postage and handling.

**ANALYSIS OF PLANE FRAMES  
ANALYSIS OF PLANE TRUSSES  
ANALYSIS OF PLANE GRIDS**

(TRS-80, CP/M, and IBM only)

ANALYSIS OF PLANE FRAMES (APF) is designed to analyze determinate and indeterminate plane frame structures. APF calculates horizontal, vertical, and rotational displacements at the joints, as well as axial forces, shear forces, bending moments, and section top and bottom stresses at the member ends. Loading may be defined as concentrated loads or moments and/or member-uniform or linearly distributed loads in either the horizontal or vertical directions. APF is fully capable of analyzing a support settlement case.

Connections between the structure members may be either rigid or hinged, and the properties may be different for each member. Supports may be located at any member end and may have restraints in the horizontal, vertical, or rotational directions. The structure limits are 20 members and 50 degrees of freedom. There is no limit on the number of load cases.

ANALYSIS OF PLANE TRUSSES (APT) is similar to APF, but is specifically suited to analyzing determinate and indeterminate plane truss structures. APT calculates horizontal and vertical displacements at the joints, and axial forces and stresses in the members. Loading is defined as concentrated joint loads in either the horizontal or vertical direction. APT is also capable of analyzing a support settlement case.

Supports may be located at any member end and may have restraints in either the horizontal, vertical, or both directions. The structure limits are 60 members and 60 degrees of freedom. There may be up to 60 different member areas. There is no limit on the number of load cases.

ANALYSIS OF PLANE GRIDS (APG) is the third member of the series and is used for analyzing plane grid structures. APG calculates out-of-plane displacements and x and y axis rotations at the joints, as well as shear forces, torsion moments, bending moments, and section top and bottom stresses at the member ends. Loading may be defined as concentrated loads or moments and/or member-uniform or linearly distributed loads. APG is also capable of analyzing a support settlement case.

Connections between members may be either rigid or hinged and properties may be different for each member. Supports may be located at any member end and may have restraints in the z displacement, and x or y rotational directions. The structure limits are 20 members and 50 degrees of freedom. There is no limit on the number of load cases.

APF, APT, and APG are interactive programs with screen menus for options and screen prompts for data input. They are designed to be "user friendly" with screen help information, editing, and "back-up" features, and require minimal data preparation. Naturally, you have the option of storing frame data for later editing and usage.

Accuracy has been checked by comparison of full capacity results with similar runs using MSCPAL Finite Element Analysis.

Requires at least 48K (TRS-80), 64K (CP/M, IBM), and BASIC. A printer is supported but not necessary.

Price: \$ 49.95 Diskette (each program)  
\$ 52.45 8-inch CP/M Disk (each program)

APF, APT, and APG may be purchased as a collection for \$119.95 (three diskettes), \$124.95 (three 8-inch CP/M disks). Sorry, collections cannot be applied toward or used in DYNACOMP's 10%-20% discounts.

**BEAMS 1-2-3**

(IBM only)

BEAMS 1-2-3 is designed to be used by both engineering students and practicing engineers to design, analyze, and study the reactions of many types of beam-loading configurations. It uses analytical solutions and the principle of superposition (finite elements, etc., are not employed) to very quickly and accurately determine the reactions (and deflections, etc.) under 60 commonly used beam-loading configurations.

Three types of beams may be examined: simply supported, cantilevered, and fixed ended. The cases covered include 29 statically supported and 31 statically indeterminate (usually the difficult ones). You may calculate and display (or print) all values of the shear, moment, deflection, bending stress, and shearing stress in three ways:

- For design, all maximum values are calculated.
- For analysis, all values at any location may be calculated.
- For study, all values at equally spaced points may be calculated.

Calculations may be done in any of four units (English, kilo-English, Metric, kilo-Metric). Also, any material may be used, or you may choose from a menu of seven common materials (A-36 steel, cast iron, aluminum-6061, brass, bronze, Douglas fir, structural concrete).

The types of loading conditions include multiple concentrated loads, uniformly distributed loads, and pure moments. Also, spring supports may be analyzed.

Because the calculations are based on analytical equations, the results are obtained very quickly and with very good accuracy.

One of the particularly nice features available in BEAMS 1-2-3 is that you are also given a diagram showing the loading conditions and reactions. This is very helpful in visualizing and organizing your results. These diagrams may also be printed if your printer is capable of high-resolution screen dumps.

BEAMS 1-2-3 is ideal for the practicing engineer who wants to quickly and easily get results, for the student wanting to check homework, for the educator who wishes to develop assignments or demonstrate beam calculations, or for anyone interested in the solution to analytical beam problems.

Requirements: 128K RAM, BASICA (graphics BASIC), IBM graphics card. An 80-column (or wider) printer is supported, but not necessary. To get printed beam diagrams, a printer capable of hi-res screen dumps is needed.

Price: \$49.95 Two diskettes

Sample display (screen dump to printer):

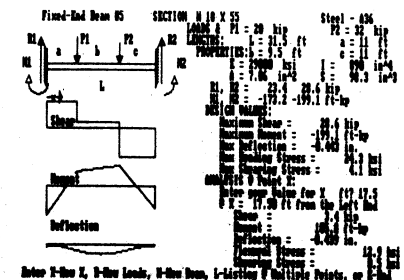

### ANALYSIS OF THREE DIMENSIONAL FRAMES

(CP/M, IBM, and TRS-80 only)

3-D FRAMES is designed to analyze three-dimensional frame structures. It calculates displacements and rotations in three directions at each joint and axial forces, shear forces, and bending moments in two directions, as well as torsional moments and combined stresses at each member end. Stress output is optional for each member and you may have up to four locations on a member cross-section with combined axial and bending stresses in two directions. This option is excellent for use on unsymmetrical members. Loading may be concentrated loads or moments and/or member uniformly distributed loads.

Connections between the structure members may be either rigid or hinged, and the properties and stress locations (0-4) may be different for each member. Supports may be located at any member end and may have restraints in the x, y, and z displacement directions and in the x, y, and z rotational directions. The structure limits are 20 members and 60 degrees of freedom. There is no limit on number of load cases.

3-D FRAMES employs screen menus for options and screen prompts for data input. It is designed to be "user friendly" with screen help information, editing, and backup features, and requires minimal data preparation.

3-D FRAMES consists of two programs. The first is for developing the frame structural data file. The second prompts you for loading information, performs the analysis, and gives all the output results.

Requires 48K (TRS-80 Models I and II), 64K (the standard minimum) for all other versions. A printer is supported, but not necessary.

Price: \$99.95 Diskette



### ANALYSIS OF THREE DIMENSIONAL TRUSSES

(CP/M, IBM, and TRS-80 only)

3-D TRUSSES is designed to analyze three-dimensional truss structures. It calculates displacements in three directions at each joint and axial forces and stresses in each member. It treats concentrated joint loads in directions x, y, and z in accordance with the defined coordinate system. A support settlement load case may also be analyzed with this program.

Supports may be located at any member end and may have any combination of restraints in the x, y, and z directions. The structure limits are 50 members and 50 degrees of freedom. There may be up to 50 different member areas. There is no limit on the number of load cases.

3-D TRUSSES employs screen menus for options and screen prompts for data input. It is designed to be "user friendly" with screen help information, editing, and backup features, and requires minimal data preparation. The truss input data file may be stored on disk for later calculation.

Requires 48K for the TRS-80 Models I and II, 64K (the standard minimum) for all other versions. A printer is supported, but not necessary.

Price: \$89.95 Diskette



### BEAM-COLUMN ANALYSIS 2nd ORDER FRAME ANALYSIS

(IBM, TRS-80, and CP/M only)

BEAM-COLUMN ANALYSIS and 2nd ORDER FRAME ANALYSIS are user-interactive programs for solving multiple-span beams and columns and plane-frame structures in the elastic range, and include the secondary effects of deflected shape under load.

A structure deforms as load is applied, changing geometry and the stiffness matrix. Conventional linear analysis, programs assume small deformations and neglect the effects of changing geometry. For structures having long spans or carrying large axial forces, results may be inaccurate using a conventional linear analysis approach.

BEAM-COLUMN ANALYSIS and 2nd ORDER FRAME ANALYSIS use non-linear elastic analysis theory, including the P-Delta effect, and work for tension as well as compression axial loads. They are intended for users with a basic knowledge of structural analysis, but were designed to be "user friendly", requiring minimal data preparation.

BEAM-COLUMN ANALYSIS can solve multiple-span beam structures with up to 40 members and up to 100 degrees of freedom. SECOND ORDER FRAME ANALYSIS can do the same for plane frames.

Connections between members may be either rigid or hinged. Concentrated loads and moments are accepted with no limit on the number of load cases. The analyses use an iterative approach, regenerating the stiffness matrix and giving results for each iteration. These values converge to a final solution if the structure is stable. Divergence indicates that the structure is unstable under the given loading.

You may select printer or screen output. Output includes member end displacements, rotations, axial forces, shear forces, bending moments, and section top and bottom stresses.

Both programs are menu-driven and use screen prompts for data entries. You may edit, store, and recall data. The manuals (B-C, 46 pages; FRAMES, 48 pages) include careful descriptions and examples.

Requires 64K (IBM and CP/M), 48K (TRS-80). A printer is supported.

Price: \$69.95 Diskette BEAM-COLUMN ANALYSIS  
\$72.45 8-inch CP/M Disk  
\$69.95 Diskette 2nd ORDER FRAME ANALYSIS  
\$72.45 8-inch CP/M Disk

Both packages may be purchased as a collection for \$99.95 (two diskettes) or \$103.95 (two 8-inch CP/M disks). Sorry, collections may not be used in or towards DYNACOMP's 10%-20% quantity discounts.



#### HINT

(Osborne double-density)

BDOS ERROR: Are you trying to load a single-density disk on a double-density system? That does not always work!

#### HINT

(CP/M)

You are in BASIC and get a TYPE MISMATCH error when trying to load a program from BASIC. Did you forget to put quotation marks around the name?

### LINEAR PROGRAMMER MINIMAX

(CP/M, IBM, and TRS-80 only)

LPM is a more powerful version of DYNACOMP's LINEAR PROGRAMMER which can treat over- and under-constrained problems, maximize an objective function, and solve simultaneous linear equations. It uses the fast and efficient Khachian algorithm to obtain the solution (or nearest solution) to the matrix inequality:

$$A \bar{X} \leq \bar{B}$$

For example, you might wish to solve the following set of inequalities:

$$\begin{aligned} X_1 &\geq 1 \\ X_2 &\geq 1 \\ X_1 + X_2 &\leq 2 \end{aligned}$$

These can be put into the desired matrix form (the manual describes how this is easily done), and solved by LPM. In this case an exact answer exists (barely!) with  $X_1 = 1, X_2 = 1$ . However, what if you wanted to consider the same equations with  $X_1 + X_2 \leq 1.8$ ? LPM will also "solve" this case and give you the closest (least violation of the inequalities) solution. This is something most linear programming routines cannot do!

LPM also handles linear programming problems in which the goal is to minimize or maximize an "objective function" which is a linear combination of the variables. For example, consider the following problem:

$$\begin{aligned} X_1 &\leq 3 \\ X_2 &\leq 7 \\ X_1 + X_2 &\leq 7 \\ 6X_1 + 7X_2 &= B \end{aligned}$$

Here the first three inequalities might describe manufacturing constraints, while the fourth might describe the profit, B. What is  $B$ ? In this case LPM will iteratively seek B and give  $B = 49$ , with  $X_1 = 0, X_2 = 7$ .

Finally, by setting up the problem with  $A\bar{X} \leq \bar{B}$  and  $A\bar{X} \geq \bar{B}$ , the simultaneous linear equation  $A\bar{X} = \bar{B}$  can be analyzed. The advantage to using the Khachian algorithm here is that the solution is found by iteration, greatly reducing round-off error.

LPM includes very easy data entry, storage, retrieval, and editing. If desired, you can also send your data tables and results to a printer.

Although LPM can handle up to 100 constraints in 20 variables, it is really more applicable to problems half that size or less. For more than that, a fast mainframe program is suggested. For solving simultaneous linear equations, the limit is 18.

Price: \$49.95 Diskette



### LINEAR PROGRAMMER

(Available for all computers)

LINEAR PROGRAMMER is a mathematical program designed to solve the standard linear programming inequality problem  $A_{11}X_1 + A_{21}X_2 + A_{31}X_3 + \dots + A_{n1}X_n < B_1$  ( $i = 1, 2, \dots, m$ ). All linear programming inequalities can be put into this form, and solved by LINEAR PROGRAMMER. Further, if an answer does not exactly exist, the "nearest" solution will be found.

Data input is simple, and the method used is fast and efficient (the Khachian algorithm). LINEAR PROGRAMMER is written in BASIC and can even be incorporated into other linear programming software as a utility. Requires 16K.

Price: \$29.95 Cassette  
\$33.95 Diskette  
\$36.45 Disk



### THE SUPERSOFT OPTIMIZER

(Apple, TRS-80, CP/M, and IBM only)

In brief, THE OPTIMIZER is a disk-based linear programming system for solving business problems.

In the strict sense, linear programming is a deterministic method of analysis used to choose the optimum course of action. In a business sense this allows a manager to decide on the appropriate course of action from among many alternatives. Routine decisions involve many tradeoffs and these can normally be grouped into two categories: constraints and objectives. For example, in choosing a new car, a consumer is faced with constraints of his budget opposed to his desire to maximize the value of the car that he buys.

Many business problems lend themselves to being formulated as trying to optimize an objective subject to some number of constraints. An investment broker, for example, may be trying to maximize his return subject to the risks his client is willing to take, or a manufacturer may be trying to minimize cost in the production of a series of products.

THE OPTIMIZER does not require that the user understand any higher mathematics. In fact, the solution of problems by this program can be undertaken strictly from a common sense point of view. The program can be used to solve problems in the areas of: production scheduling, personnel assignment, product buying, product pricing, personal finance, and many more. The problems which can be solved are limited only by the insight of the user. The importance of this type of problem solving is attested to by the fact that most large businesses have full time programming staffs which work only these types of problems.

THE OPTIMIZER also provides sensitivity analysis including the shadow price (dual variable), range of resources over which the shadow prices are valid, slack quantities (helpful in further improving efficiency or costs), and stability (how sensitive is the solution to the objective function coefficients).

The manual is well written and contains tutorial information as well as examples.

Requires at least 48K RAM; a printer is optional. The Apple and TRS-80 versions are in machine language; the TRS-80 version requires two disk drives.

SuperSoft's list price is \$200. DYNACOMP's price is \$169.95.

### ABOUT PRICES

DYNACOMP's pricing policy is simple: for software published by DYNACOMP, we survey what is currently available and try to price our products at 50% to 75% of that; sometimes even less.

For products we distribute (which are published by other companies), we try to give you a direct discount of 10% to 20%. Even when we can't give you a direct discount, you can use our 10% (3-4) or 20% (5 or more) quantity discounts to reduce your costs substantially.

In short, we try to give you good value for what you pay.

Which way are the prices going? If you have been following DYNACOMP's prices for the past eight years, you may have observed that they have generally stayed either the same or increased slightly (roughly 10%), except in the "games" category. The prices for games have fallen significantly in some cases (e.g., arcade games). Also, DYNACOMP has taken the approach of combining several games into one package, thereby increasing the value/price ratio.

### PROCESS ENGINEER'S CONVERSION KIT

(Apple only)

PROCESS ENGINEER'S CONVERSION KIT enables you to convert between units commonly used in the process industries.

Measurements of temperature, pressure, mass, density, and other process parameters are easily converted between standards. This is done without the tedium of researching and entering formulas. Convenience is ensured by a menu-driven spreadsheet screen format. Extensive error checking makes certain that no out-of-range or illegal values can be entered.

Most conversion tables published in reference books are deficient in two areas: they often do not cover the required range, and the resolution is usually too coarse, requiring interpolation. PROCESS ENGINEER'S CONVERSION KIT lets you create your own tables, the way you want them! Your table can be completely specified in the time it takes to do a single calculation on a hand calculator.

PROCESS ENGINEER'S CONVERSION KIT actually contains ten programs, each one dedicated to certain categories of standards conversion. While being designed primarily for engineers, technicians, operators, and production staffs in the process industries, these programs may be easily adapted to many other uses ranging from commercial exchange rate to converting Cordon Bleu recipes written in metric units.

Price: \$19.95 Diskette

### ROAD ENGINEERING

(IBM only)

ROAD ENGINEERING consists of two programs for road design and construction. They are very user friendly. There are no commands to learn and you simply answer the prompts as they appear on the screen. These programs have been in use for more than six years, and have been fine-tuned to be both productive and easy to use.

CONSTRUCTION CURVES computes curve details from the deflection angle and the radius or tangent. Results are the deflection, radius, arc, chord, and external. You can print a field layout for staking at any station spacing and for any offset desired. The printout lists the deflections, the long arcs and chords, and the short arcs and chords at each station.

ROAD GRADES computes and prints a continuous list of design center and gutter elevations at any station spacing, for any road width and X-fall% specified. You can enter the station and elevation of numerous points, with or without vertical curves. Automatically saves data to disk for later revisions.

Requires IBM PC, 64K, one drive, and an 80-column printer.

Price: \$95.00 Diskette

### HINT

(cassettes)

If you are experiencing tape loading problems, the tape may be unevenly wound and binding. To free it up, sharply slap the flat side of the cassette down on a hard surface. This forces all of the tape against one side of the housing evening up the edges and allowing it to run smoothly again.

### ENGINEERING COLLECTION #1

(CP/M and IBM only)

Here is a collection of ten programs which should be included in any engineer's library software:

1. ANTENNA PLOT: You may specify up to 100 array elements and their locations.
2. BODE PLOT: You specify the poles and zeroes, the program plots and lists the response.
3. CONVOLUTION: Input two waveforms and get the convolution, both plotted and listed.
4. FOURIER PLOT: Produces the discrete Fourier transform of a set of data. Plots and lists. You may also specify the number of harmonics to be computed, and reconstruct using these harmonics.
5. NUMBER CONVERSION: Converts between decimal, binary, octal and hexadecimal.
6. REACTOR SIMULATION: Based on reactor kinetics equations found in NUCLEAR ENGINEERING HANDBOOK (by McGraw-Hill).
7. CONTROL SYSTEM SIMULATION: Simulates a second order closed loop control system. Responses may be listed, saved and plotted.
8. SPLOT: Plots sets of X, Y data on 80 column printer.
9. PPLOT: Similar to SPLOT, but for dot matrix MX-80.
10. SCIPLOT: Similar to SPLOT, but plots on screen.

Each of these programs may be called from the main menu provided on the DYNACOMP diskette, or each may be incorporated into your own BASIC programs (they are written in BASIC). Even if you do not have an immediate application, this collection has considerable education value. Sample data sets are included. Supplied with 62 page manual showing examples and listings.

Price: \$39.95 Diskette  
\$42.45 8-inch CP/M Disk

### LADDER NETWORK

(TRS-80, CP/M, and IBM only)

LADDER uses the technique of describing a network as a series of cascaded two-ports. This representation is sometimes pictured as a "ladder". Each two port is described individually, from load to source, in a data file generated by following the program prompts. Each element type and value is then read and an "ABCD" matrix for each element is generated. This matrix describes the transfer characteristics of the two-port element and the multiplication of two or more "ABCD" matrices will yield the total transfer characteristic of the series of two-ports. LADDER uses matrices (with complex numbers) to describe the transfer characteristics of passive networks (capacitors, resistors, inductors, and transmission lines). The network architectures may include parallel and series branches to any depth, open and shorted stubs, and two parallel or series ladder networks. All elements (except resistors) require a quality factor or loss figure be defined at a single, operator defined, frequency. With this information, the network responses are determined using "real world" components. This program can handle networks consisting of up to 50 two-port elements. Requires 32K.

Price: \$29.95 Cassette  
\$33.95 Diskette  
\$36.45 8-inch CP/M Disk

Sample screen photographs:

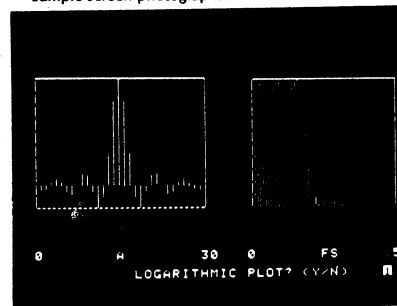

DIGITAL FILTER DESIGN TUTORIAL

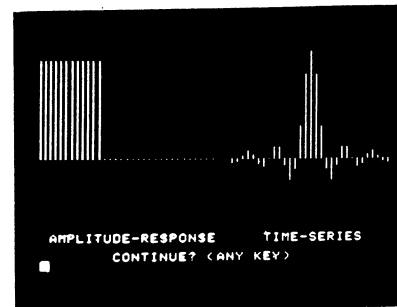

DIGITAL FILTER DESIGN TUTORIAL

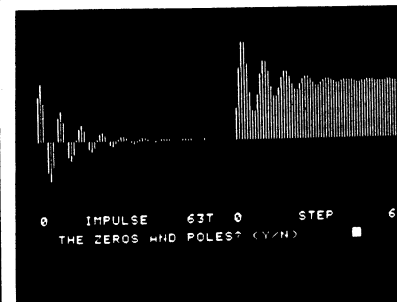

Z-PLANE TUTORIAL

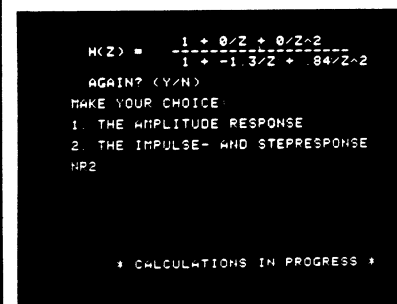

Z-PLANE TUTORIAL

See ENGINEERING TUTORIALS section.

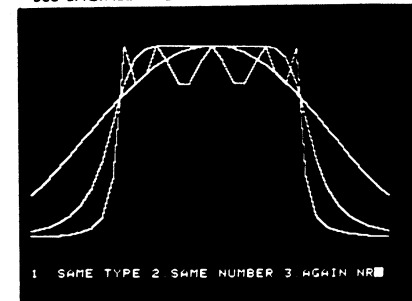

S-PLANE TUTORIAL

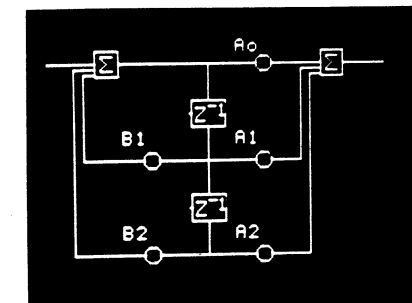

BIQUAD FILTERS TUTORIAL

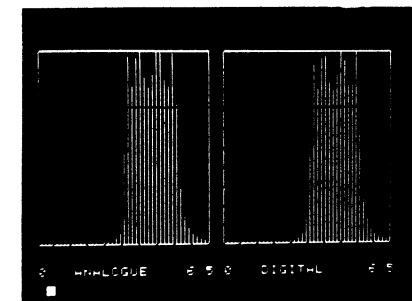

BIQUAD FILTERS TUTORIAL

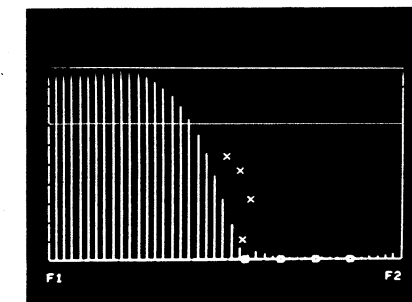

BIQUAD FILTERS TUTORIAL

BIQUAD FILTERS TUTORIAL

**ACTIVE CIRCUIT ANALYSIS PROGRAM (ACAP)**

(available for all computers except North Star &amp; Atari)

ACAP is an active and passive circuit analysis program. It can be used to solve for the node voltages of a network. The circuit elements which can be analyzed by ACAP are resistors, capacitors, inductors, voltage sources, current sources, and a voltage-controlled current source. To describe a circuit to ACAP, you enter it in a simple algebraic form. Using the ACAP editor, you may easily enter and change the element descriptions. You may also save the circuit description on tape/diskette in order to later recall it.

To better understand the exceptional features of ACAP, its structure is briefly outlined below.

Requires 48K.

Price: \$39.95 Cassette  
\$43.95 Diskette  
\$46.45 8" CP/M Disk

The circuit description must have nodes numbered 0 through N when there are (N+1) nodes in the circuit. The maximum number of nodes in a circuit description is 40. The program outputs node voltages referenced to node 0, or outputs node gains in db referenced to a specified node. "n1" through "n4" are node numbers. "Value" is the component value. "%-tol." is the percent tolerance of the component (%-tol. is optional). The r-value and i-value are the source values: r-value is the real part and i-value is the imaginary part (i-value is optional).

ELEMENT	FORMAT
Resistor	
R (resistance)	n1 n2 R value %-tol.
Capacitor	
C (capacitance)	n1 n2 C value %-tol.

Inductor	
L (inductance)	n1 n2 L value %-tol.
Resistor	
G (conductance)	n1 n2 G value %-tol.
Voltage Source	
V (voltage)	n1 n2 V r-value i-value
Current Source	
I (current)	n1 n2 I r-value i-value
Voltage-Controlled Current Source	
VC (conductance)	n1 n2 VC n3 n4 value %-tol.

Note that transistors/amplifiers can be simulated with the voltage-controlled current source. As you can see from the above element description, ACAP includes an analysis of the uncertainty in the circuit response due to variations in the components. Some of the commands available to ACAP are:

DB - output results in decibels: DB <node 2>  
F - frequency to be used: FCF initial, F final, fstep>  
PRINT - Print node voltages: PRINT <n, n, n, n, n, n>  
REPEAT - Repeat calculation (to build statistics)  
STAT - Calculate mean and standard deviation at nodes:  
STAT <n, n, n, n>

The STAT command uses the % tolerance values and the REPEAT number to build a MONTE CARLO description of the range of values at a node. The F command permits an analysis of the frequency response of the circuit.

As you can imagine, it is difficult to describe ACAP in the limited space of a catalog. However, you can appreciate its power!

Comes with a 12 page instruction manual.

**LOGIC SIMULATOR**

(Apple and IBM only)

There are two ways to test a circuit design: build a prototype and experimentally examine all the input/output conditions, or probe the circuit's performance using LOGIC SIMULATOR. The latter approach is faster and less expensive, as well as being more amenable to rapid design iterations.

The circuit elements which may be treated by LOGIC SIMULATOR include the following:

- Multiple Input AND, NAND, OR, NOR, EXOR and EXNOR Gates
- Inverters
- J-K and D Flip-Flops
- One Shots

Inputs may be clocked in with varying clock cycle lengths and displacements. Change of state delays may be introduced to test for real life glitches and race conditions. The response of the system is available for display every clock cycle and, at the user's option, a timing diagram for any given set of logic nodes (including the inputs) may be simultaneously plotted using HIRIS graphics.

All this is accomplished with a simulation language (operated through BASIC) designed specifically for this task. This language is both easy to learn and quick to use.

LOGIC SIMULATOR is supplied with a 9 page instruction manual and is ideal for use in the classroom where the student may design logic circuits and quickly test them. Another quality engineering program from DYNACOMP.

Requires 48K.

Price: \$39.95 Cassette  
\$43.95 Diskette  
\$46.45 8" CP/M Disk

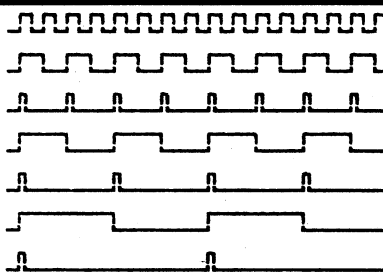
**WIREFMAP**

(CP/M, IBM, and TRS-80 only)

WIREFMAP is designed to allow electronic circuits and schematics to be computerized for the purpose of generating parts lists, wire lists, and signal lists. These lists may then be used for the purposes of production, debugging, trouble shooting, and documentation of the circuit. WIREFMAP is especially useful for prototype, wire-map, and point-to-point circuitry, since the signal listing may be used as a guide to correctly wiring the circuit. The program also provides an easy means of checking for errors. Any open signals will be flagged during a wirelist printout. Includes easy to use data editing features.

Requires 16K (cassette), 32K (disk).

Price: \$39.95 Cassette  
\$43.95 Diskette  
\$46.45 8-inch CP/M Disk

**LOGIC DESIGNER**

(North Star, Osborne and CP/M only)

LOGIC DESIGNER is an interactive digital design program (not a simulator) which greatly speeds up and simplifies digital hardware design. Error-free solutions of combinational logic problems having between 2 and 8 input variables are obtained quickly and easily. Previously, such capability has been available only on large mini and mainframe computers.

The program prompts for a user-defined truth table (including "don't care" conditions) and reduces the input data into two boolean logic equations. Either equation can then be directly and easily converted into digital hardware. The program asks for all necessary information and checks the responses for format errors. An entry editor is provided to allow corrections. Facilities are provided for modification, addition, or deletion of entries. You may also view the entries on command. The editor provides a fast and easy method of correcting errors without re-entering the entire data base.

Due to large amount of data reduction required for complex problems, speed is very important. The reduction process is therefore accomplished with fast and efficient assembly language code. Without it, the program run time would be greatly increased. Manual: 15 pages.

Requires 16K of program memory and an 8080/280 CPU.

Not available for Canon or Heath/Zenith.

Price: \$34.95 Diskette  
\$37.45 8" CP/M Disk

**ACTIVE CIRCUIT ANALYSIS PROGRAM (KCAP)**

(Atari only)

KCAP is similar to ACAP described above. It does not contain the percent tolerance and REPEAT/STAT features. However, it does include graphics (see below), and "macros" for bipolar and FET transistors, and amplifiers. Requires 48K, and one disk drive.

Price: \$49.95 Diskette

Sample display:

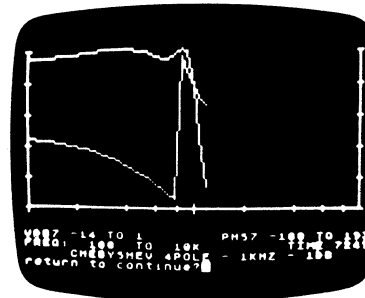
**MICROCOMPUTER LOGIC DESIGN PROGRAM**

(Apple and IBM only)

MICRO-LOGIC was created to enhance the productivity of electronic digital design by providing an interactive drawing and simulation system, allowing you to quickly design and predict the performance of a circuit without your having to actually build it.

This software product will help you to:

- Draw a logic diagram directly on the CRT screen.
- Run a timing simulation of the network responding to user-defined input sources.

It's like building a breadboard and hooking up signal sources and logic analyzers to see what happens ... except that it's faster.

Logic diagrams are drawn directly on the screen using the Designer program. Using the keyboard commands, you move the drawing cursor around on the screen adding or deleting gates. Each time you add a gate, the system draws it at the cursor position. Drawing interconnecting lines and contacting gate input and output nodes using the PLOT and CONTACT commands allows you to create any type of logic network. Completed logic diagrams can then be saved in a diskette file.

When the drawing is complete, the system automatically prepares the netlist needed for the simulation.

Users may create their own gates. Up to 36 different 5-input functions may be defined and subsequently used in any network. Gate characteristics include name, delay, 64-state truth tables, and input/output clocking.

**Specifications**

Simulation Type	Boolean State/Timing Simulator
Input	Macro Networks. Drawn Logic Diagram. Keyed-in Network Description. Signal Source and Patterns. Gate Truth Tables & Characteristics. Clock Waveforms.
Output	Logic Diagram. Timing Simulation in graphic or printer form. Fanout Report. Compare Report. Input Pattern Listings. Gate Library Listings Network Listings. Clock Waveform Listings.
Components Supported	NOR/OR, NAND/AND, Exclusive-OR, D FLIP FLOP, J FLIP FLOP, JK FLIP FLOP, Tri-State Gate, User-defined Gates, and powerful 16-pin MACROS.
Gates	1750 max. (IBM): 432 max. (APPLE)
Gate Types	36 max. (IBM): 18 max. (APPLE)
Data Chan's	36 max. (IBM): 18 max. (APPLE)
Hardware Required	APPLE II, II plus, IIe with 64K RAM 2 Disk Drives, DOS 3.3 80-column Printer is Optional IBM PC with 128K RAM. Color Graphics Adaptor Board. 2 Disk Drives, DOS 1.1. 80-column Printer is optional. Compatible with most MS DOS systems.
Medium	Supplied on a 5 1/4" mini floppy diskette with instruction manual.
Price	\$399.95
Evaluation Kit	\$75.00. Identical to main product except limited to networks of 20 gates.

### MICROCOMPUTER CIRCUIT ANALYSIS PROGRAM

(Apple and IBM only)

MICRO-CAP is a professional design tool created to enhance the productivity of electronics design by providing an interactive drawing and analysis system. It allows an engineer to quickly design and predict the performance of a circuit without having to actually build it.

The software product enables the user to:

- Draw an electronic circuit diagram directly on the CRT screen.
- Run a time-domain simulation of the circuit responding to user-defined input sources.
- Perform an AC (Bode) analysis showing Gain and Phase Shift vs. Frequency.
- Perform a DC Transfer Characteristic analysis showing Output Voltage vs. Input Voltage.

It's like building a breadboard and hooking up signal sources and instruments to see what happens ... except that it's faster.

Circuit diagrams are drawn directly on the screen using the Designer Module. Using the keyboard you move the drawing cursor around on the screen adding or deleting components. Each time you add a component the system draws it at the cursor position. Drawing interconnecting lines allows you to create any type of circuit diagram. Completed circuit diagrams are then saved in a diskette file. A typical completed circuit diagram looks like this:

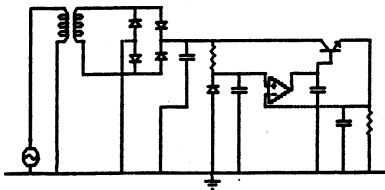

When you have completed a circuit drawing you can perform a Transient Analysis. In this mode the system calculates the voltage as a function of time on any two nodes in the circuit. The results look a lot like a dual-trace oscilloscope display:

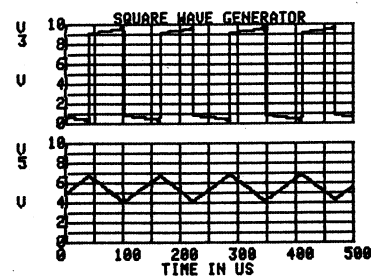

**DO YOU HAVE ANY SUGGESTIONS**  
on how to make the DYNACOMP catalog better?  
Please write and tell us.

Alternatively you can perform an AC analysis:

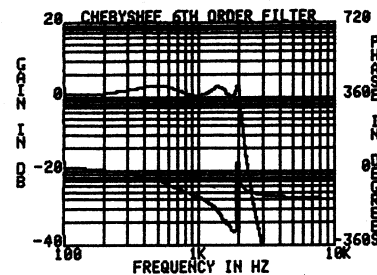

Transient Analysis can also be generated in printer-plot or tabular fashion.

#### Specifications

Analysis Modes	AC Analysis (Bode Plots). DC Transfer Characteristic. Non-Linear Time Domain
Input	Drawn Circuit Diagram Keyed Circuit Description Standard Components Library
Output	CRT Bode Analysis (or Graphics Dump). CRT DC Analysis (or Graphics Dump). CRT Circuit Diagram (or Graphics Dump). CRT Waveforms (or Graphics Dump). Printer Plot of Waveforms. Printer Tabular Listing of Node Voltages. Network Listing.
Components Supported	Resistors, Inductors, Capacitors, Batteries, Sinusoidal Voltage Sources, Programmable Waveform Voltage Sources, Diodes, OP AMPS, Bipolar and MOS Transistors, Transformers, Polynomial and User-defined Sources, and Voltage, Current, or Time-Controlled Switches.
Nodes	40 Maximum
Hardware Required	Apple II with Applesoft in ROM, or Apple II Plus or APPLE IIe with 64K RAM, DOS 3.3, and 2 Disk Drives. 80-column Printer is optional.
	IBM PC, 128K RAM. Color Graphics Adapter Board. DOS 1.1, 2 Disk Drives. 80-column Printer is optional.
Medium	Supplied in compiled object code on a 5 1/4" mini-floppy diskette with a 130-page instruction manual.
Price	\$399.95
Evaluation Kit	\$75.00. Identical to the main product except limited to 5 node circuits. May be credited toward purchase price. Evaluation kits are not refundable.

### FFT ANALYSIS TUTORIAL

(Apple only)

FFT ANALYSIS TUTORIAL (FAT) is a software tutorial package for the person who wishes to better understand the relationships between the forward and reverse (inverse) FAST FOURIER TRANSFORM. This is ideal for the professional who has taken a course on Fourier theory and would like a refresher which quickly and concisely pulls the concepts together and demonstrates them graphically.

The 50-page manual starts with a discussion of the discrete and fast Fourier transforms, including sampling, aliasing, side bands, etc. The inverse FFT is then introduced along with frequency domain filtering and signal reconstruction. RC and transmission line filtering examples are included.

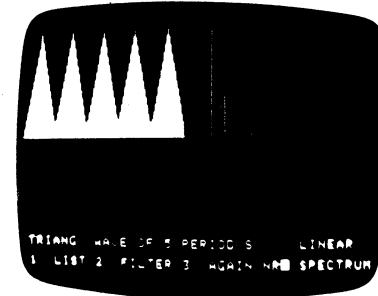

The software follows the manual. 128 point transforms are used. In addition, if an A/D converter is used, the captured data may be analyzed by FAT.

In essence, FAT is a combination and extension of DYNACOMP's FFT and IFFT tutorial programs. The package requires prior knowledge of the Fourier transform so that the equations in the manual can be understood.

Price: \$59.95 Diskette

Sample displays:

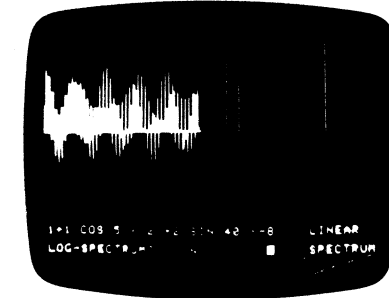

### MICRO CAP II MICROCOMPUTER CIRCUIT ANALYSIS PROGRAM ADVANCED VERSION

(IBM and Macintosh only)

MICRO-CAP II includes all of the features of MICRO-CAP with the following enhancements:

- **High Speed Sparse Solvers:** These solvers increase the simulation speed up to 600% over MICRO-CAP and increase the maximum network size to 100 nodes.
- **Advanced Device Models:** Provides advanced bipolar, opamp, and transmission line models.
- **Advanced Designer Features:** A multi-page drawing capability with parameter and node number labeling capability makes creating circuits easy.
- **Macro Capability:** User-defined macros increase modelling flexibility.
- **Worst-case Analysis:** Creates multiple simulation plots by randomly selecting component values from user-specified tolerances.
- **Temperature Stepping:** Creates multiple plots for as many temperature steps as are desired.
- **Fourier Analysis:** Analyze and plot Fourier spectrum.

IBM version requires 256K of RAM (otherwise, the requirements are the same as those for MICRO-CAP).

Price: \$100.00 Evaluation kit (two disks)  
\$799.95 Full package (two disks)

Evaluation kits are not refundable.

NOTE: Macintosh version requires 512K and two disk drives.

#### MICRO-CAP Reviews:

A highly recommended analog design program ...  
PC TECH JOURNAL (3/84)

A godsend for the busy engineer ...  
SOFTALK Magazine (5/83)

A valuable tool for circuit designers ...  
PERSONAL SOFTWARE magazine (11/83)

### FILTER ANALYSIS

(Apple only)

FILTER ANALYSIS calculates the effective attenuation of a electrical filter composed of passive elements. The effective attenuation is the ratio (in decibels) of the power delivered (to the load) to the maximum power available (from the source). For the case of lossless filter components (i.e., perfect inductors and capacitors), this ratio is the frequency response of the filter.

For example, a typical filter circuit which might be examined by FILTER ANALYSIS is shown below. As you can see, there is considerable flexibility in dealing with serial/parallel components as well as multiple stages.

The results of the analysis are available in several forms, including a tabular display of the attenuation and reflection coefficients, and a graphical display of the attenuation in decibels versus log-frequency (see below).

FILTER ANALYSIS is written in Applesoft BASIC, but emulates its own very friendly language. The commands are T (text for comments), E (enter data), R (run analysis), C (change data), L (list circuit description), Q (quit) and P (plot).

FILTER ANALYSIS is a very powerful tool for quickly and easily testing filter designs.

Price: \$29.95 Cassette  
\$33.95 Diskette

Typical (though not practical) circuit:

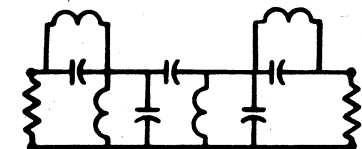



## FOURIER/FILTER ANALYSIS

### FOURIER ANALYZER

(available for all computers)

FOURIER ANALYZER is a scientific program which can be applied to examine the frequency spectrum characteristics of defined duration signals, such as groups of pulses. The user inputs a data set which is Fourier transformed into the frequency space descriptors of amplitude and phase. The amplitude and phase results are displayed in tabular form. The input data and calculated results may also be plotted at the user's option.

Shown below are plotting examples in which the input data represented a square wave shifted off the origin. The amplitude plot clearly shows the characteristic "sinc" function form. The phase plot shows the expected discrete phase changes associated with the "sinc" function superposed on the linear phase change expected from the Shifting Theorem.

The input data set is limited in extent only by the memory size of the host computer, and is not restricted to equally spaced values.

FOURIER ANALYZER is certainly a powerful and educational tool for the engineer, scientist, student, or anyone involved in cyclic phenomena (e.g., music, stocks, etc.).

Accompanying FOURIER ANALYZER is a 20 page manual.

Requires 16K of program memory (Atari version requires 24K).

Price: \$19.95 Cassette  
\$23.95 Diskette  
\$26.45 8" CP/M Disk

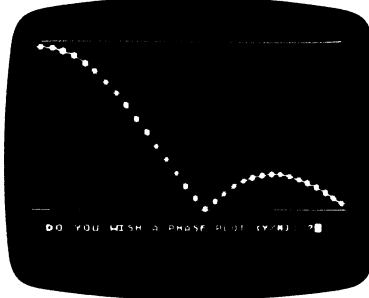

### ELECTRICAL ENGINEERING TUTORIALS

(Apple only)

DYNACOMP has several education programs designed for electrical engineers. See the EDUCATION section for:

FAST FOURIER TRANSFORM TUTORIAL  
DIGITAL FILTER DESIGN TUTORIAL  
Z-TRANSFORM TUTORIAL  
S-PLANE TUTORIAL

### TRANSFER FUNCTION ANALYZER

(available for all computers)

TRANSFER FUNCTION ANALYZER is a frequency spectrum analysis package designed with the engineer in mind. It applies the concept of the Fourier integral transform to an input data set to provide a frequency domain representation of the function approximated by that input data. TFA is based on DYNACOMP's popular FOURIER ANALYZER, but includes special data handling features. It also presents the results in conventional engineering terms (decibels, log-frequency).

The user may save and recall both the input data file and previously calculated results. Data files may be loaded (from cassette, diskette, or disk), added to, deleted from, and generally edited. As with FOURIER ANALYZER, the input data may be plotted before the calculations are started. The frequency domain results may also be plotted, as well as saved (to be later recalled for new plots). In addition, the analyses are easily separated with different frequency parameters without re-entering the data.

The transformed results are displayed in conventional engineering form. The amplitude points returned are in decibels (DB) relative to the peak value (0 DB). The phase is in degrees. The frequency transform is calculated in equal log-frequency intervals as is common practice in Acoustical and Electronic Engineering.

The frequency results may be optionally plotted. When the amplitude plot is performed, it is in decibel/log-frequency format. This permits easy identification of the characteristic "roll-off" in frequency response. For example, a 9 DB/octave (e.g., 10 log (F/W)) straight line roll-off of a three pole filter is immediately apparent from the plot.

TFA was originally designed as part of a consulting assignment involving the analysis of amplifier transfer function. It is, therefore, a program which has been tested in an actual

commercial application. In this particular case, the output data corresponding to the real time response of an amplifier to an input pulse ("delta function") was used directly as input to TFA, and the frequency amplitude results directly gave the transfer function for the amplifier.

Whereas DYNACOMP's FOURIER ANALYZER is well suited to the basic science and educational fields as well as many engineering applications, TRANSFER FUNCTION ANALYZER is a key tool for the electronics and acoustics engineer involved in the analysis of limited duration signals. Included in this package is a well written 20 page manual.

Requires 16K of program memory (Atari version requires 24K).

Price: \$25.95 Cassette  
\$29.95 Diskette  
\$32.45 8" CP/M Disk

Sample display (Atari):

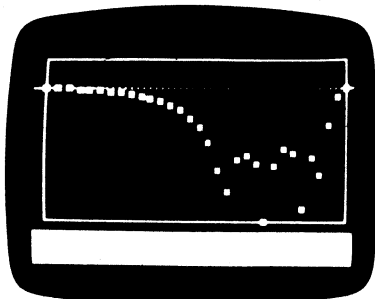

### ELECTRICAL ENGINEERING TUTORIALS

(Apple only)

DYNACOMP has several education programs designed for electrical engineers. See the EDUCATION section for:

FAST FOURIER TRANSFORM TUTORIAL  
DIGITAL FILTER DESIGN TUTORIAL  
Z-TRANSFORM TUTORIAL  
S-PLANE TUTORIAL

## FOURIER/FILTER ANALYSIS

### HARMONIC ANALYZER

(available for all computers)

HARMONIC ANALYZER is the third in DYNACOMP's series of Fourier transform software packages. Whereas FOURIER ANALYZER and TRANSFER FUNCTION ANALYZER (TFA) were designed with limited duration signals in mind, HARMONIC ANALYZER is specific to repetitive wave forms (cyclic processes).

All the data entry, storage, retrieval, and editing features of TFA have been included, as well as the signal and transform plotting functions. The Fourier integral has been replaced with a Fast Fourier Transform (FFT) routine which is the essence of the harmonic analysis. A cubic spline interpolation procedure has been added so that the user may transform irregularly spaced data. Also, the data need not be entered in temporal order; it is sorted before being transformed.

The spline interpolation and sorting features are unique to HARMONIC ANALYZER and will be appreciated by those familiar with other FFT programs which require the data to be both in order and evenly spaced. The spline interpolation scheme was in particular chosen over others to minimize the unwanted interpolation oscillation ("ringing") associated with abrupt signal changes, such as square wave steps.

The FFT employed is a base-2 algorithm; that is, the number of data points must be an even power of 2. This places a small restriction on the input data set, but increases the speed of the transform calculation.

HARMONIC ANALYZER is a program which should be in the software library of every scientist, engineer, or experimenter who deals with repeating waveforms.

A 16 page manual is included. Requires 16K of program memory (Atari version requires 24K).

Price: \$29.95 Cassette  
\$33.95 Diskette  
\$36.45 8" CP/M Disk

Sample display (Atari):

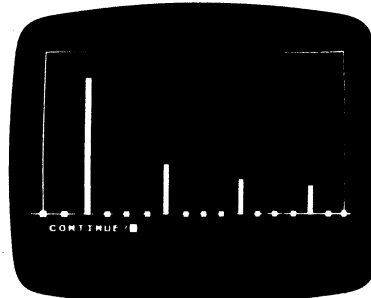

### COLLECTIONS

DYNACOMP offers reduced prices on the following collection:

FOURIER ANALYZER, TRANSFER FUNCTION ANALYZER and HARMONIC ANALYZER are available for:

\$61.95 (3 Cassettes)  
\$73.95 (3 Diskettes)  
\$79.95 (3 8" Disks)

## FOURIER/FILTER ANALYSIS

### DIGITAL FILTER

(available for all computers)

DIGITAL FILTER is a comprehensive data processing program which permits the user to design his own filter function or choose from a menu of filter forms. The filter forms are subsequently converted into non-recursive convolution coefficients which permit rapid data processing. In the explicit design mode, the shape of the frequency transfer function is specified by directly entering points along the desired filter curve. In the menu mode, ideal low pass, high pass and bandpass filters may be approximated to varying degrees according to the number of points used in the calculation. These filters may optionally also be smoothed with a Hanning function. In addition, multi-stage Butterworth filters may be selected. Features of DIGITAL FILTER include plotting of the data before and after filtering, as well as display of the chosen filter functions. Also included are convenient data storage, retrieval, and editing procedures.

The format of the data storage is consistent with that used by REGRESSION I, REGRESSION II, TRANSFER FUNCTION ANALYZER, and HARMONIC ANALYZER. This permits the user to selectively filter data before processing by any of the above programs.

DIGITAL FILTER is extremely well documented with a 48 page manual which carefully describes the operation of the program as well as the supporting theory. The manual is sufficiently complete that it can be used in conjunction with the software to teach many of the principles involved in digital filtering.

Price: \$49.95 Cassette  
\$53.95 Diskette  
\$56.45 8" CP/M Disk

Sample display (Atari):

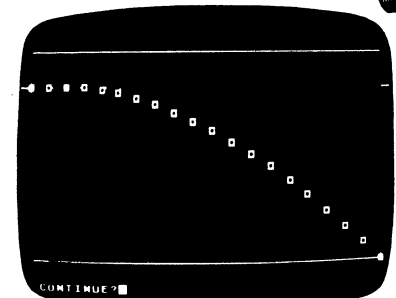

### EXCERPTS from a review of DIGITAL FILTER

(O.K. Griffith, Jr., CHOICE, June 1985)

"The program Digital Filter is an implementation of a general-purpose filter, written in the BASIC language for a personal computer. ... [It] is a real filter and provides an excellent introduction to the concepts and use of the digital filter. The greatest appeal of this program would be to the engineering and science departments. The documentation is short but good ... The theory upon which the program is based is clearly presented with several references. Annotated examples are given in the manual and data files are provided on the program disk so that the user can actually duplicate the examples. Overall a good program that would be useful as a self-teaching tool for anyone having a moderate motivation to become familiar with digital filters. For college science and engineering collections."

**THE MATH MASTER SERIES**  
(Apple, IBM, TRS-80)

We learned a lesson from DYNACOMP's BASIC SCIENTIFIC SUBROUTINES (BSS) series: People want to extend the math capabilities of their machines. With BSS you can select any of a large number of subroutines written in BASIC and append them on to your own programs. Now a few of the more popular routines have been converted to machine language and have been included in BASIC as special statements. For example:

100 CMD MAT A = INV(B)

is a statement in the MATRIX MASTER enhancement of BASIC which calculates the inverse of matrix B and puts it in matrix A. As you can see, the program statement is very simple and easy to use. Also, the calculation is fast.

THE MATH MASTER SERIES comes in several modules:

MATRIX MASTER                      BOOLEAN MASTER  
POLY MASTER                          COMPLEX MATRIX MASTER  
POLY ROOT MASTER                    EDIT MASTER

MATH MASTER EXECUTIVE  
FAST FOURIER TRANSFORM MASTER

All but the EXECUTIVE are free-standing modules, that is, you need nothing but that module and BASIC to implement the enhancement. However, if you want to use two or more modules simultaneously, the MATH MASTER EXECUTIVE is also required to coordinate the modules.

Note: Modules are read in only when a *different* module is called. Ten matrix calculations in a row result in only one MATH MASTER module load.

Each module is described below in some detail. As you will see, you can greatly enhance the capabilities of your BASIC with MATH MASTER modules.

**MATH MASTER EXECUTIVE**  
(Apple, IBM and TRS-80 only)

The MATH MASTER EXECUTIVE automatically loads in MATH MASTER programs as they are needed. For example, suppose a program contains these two statements:

60 CMD MAT A = B+C  
70 CMD POLY R =S+T

First, MATRIX MASTER would be automatically and quickly loaded into RAM and executed to give the sum of matrices B and C in matrix A. Then POLY MASTER would be automatically loaded into RAM and executed to give the sum of polynomial coefficient vectors S and T in vector R. The only effort required on the part of the user is that of making sure that POLY/EXC and MAT/EXC reside on a disk in one of the disk drives.

Price: \$19.95 Diskette

Note: 128K RAM (or more) needed for the IBM version of MATH MASTER EXECUTIVE.

**MATRIX MASTER**  
(Apple, IBM, and TRS-80 only)

MATRIX MASTER *greatly* simplifies and *speeds up* those very time-consuming matrix operations which are often encountered. For example, a 20 by 20 matrix can be inverted in only 15 seconds (IBM version; single precision). That's fast! The typical BASIC command would be:

100 CMD MAT A = B+C

The quotations supported are addition, subtraction, multiplication, transportation, inversion, scalar operations, identity matrix creation, and fast storage and retrieval. Although available in single- and double-precision versions, double precision is recommended for matrix inversion.

Price: \$29.95 Diskette (Single Precision)  
\$37.95 Diskette (Double Precision)  
\* Not available for Apple

**FAST FOURIER TRANSFORM MASTER**  
(Apple, IBM, and TRS-80 only)

FFT MASTER is presently the most popular of the MATH MASTER series because of the need for a truly *fast* FFT and one that has the features this has. For speed, consider the following: 26 seconds (IBM version) for a 1024-point single-precision real transform!

Two versions of FFT MASTER are available:

- SINGLE PRECISION for "run of the mill" analysis.
- DOUBLE PRECISION for exacting analysis.

The size of the array processed is limited only by available RAM. All of the transforms are performed "in place". This saves memory. And all of the transforms can be performed with Hanning windowing. Also, inverse transforms can be computed.

Here are some examples of the command formats:

100 CMD FFT A REAL

The N elements in A(I) are taken to be real and the complex transform is returned in A(I); A(O) and A(1) are the real and imaginary parts of the first of the N/2 output points.

200 CMD FFT A INVERSE

The inverse transform of the *complex* array A(I) is returned.

300 CMD FFT A REAL HANNING

Modifiers can be compounded. Here the real array A(I) is windowed before being transformed.

300 CMD FFT A MAG(B)

The magnitude of the transform of A(I) is returned in B(I).

400 CMD FFT A PHASE(C)

The phase (in radians) of the transform of A(I) is returned in B(I).

There are also utilities for quickly storing and retrieving data.

As usual with FFT algorithms, FFT MASTER is limited to 2<sup>m</sup> data points.

Price: \$49.95 Diskette (Single Precision)  
\$57.95 Diskette (Double Precision)  
\$49.95 Diskette (Integer—TRS-80 only)

\*Not available for the Apple

**POLY ROOT MASTER**  
(Apple, IBM, and TRS-80 only)

POLY ROOT MASTER allows you to determine quickly and easily the roots of polynomials using a simple command structure:

100 CMD ROOT A = R(B) AND I(C) USING(D)

when A is the polynomial array, B is the real root vector, C is the imaginary root vector, and D is a dummy work array. For example, B(O) and C(O) are the real and imaginary parts of the first root found, etc. Simple and fast.

Price: \$17.95 Diskette (Single Precision)  
\$25.95 Diskette (Double Precision)  
\* Double Precision not available for Apple

**BOOLEAN MASTER**  
(Apple only)

BOOLEAN MASTER adds 23 new 8-bit and 16-bit logical functions to Applesoft BASIC. You can shift, bit set, bit reset, bit test, complement, XOR, OR, negate, PEEK/POKE (16 bit). Most of these functions can be either 8-bit or 16-bit. Also, there is a base-conversion command (base range: 2 to 36). A typical command line might look like this:

100 &BOOL (B=BSET(A,I))

In this case, the fifth bit in A is set and the result is returned in B.

If you are involved in bit mapping or other bitwise logical operations, you will find this machine-language enhancement to Applesoft BASIC a huge time saver. Requires 48K.

Price: \$29.95 Diskette

**EDIT MASTER**  
(Apple only)

You do not need EDIT MASTER for the TRS-80 or the IBM; they already have very nice program line editors. But the line editor in the Apple is *awful*. EDIT MASTER solves this problem. With EDIT MASTER you can easily insert, delete, and find characters. You can zap sections of a line, pack lines (remove unnecessary spaces), scroll through text, move to the front or end of a line, etc. In other words, EDIT MASTER is what should have been included in Applesoft. Further, EDIT MASTER is fully integrated with the MATH MASTER series; it can be part of the automatic EXEC library. In essence, it adds more commands to Applesoft. Requires 48K.

Price: \$19.95 Diskette

**COMPLEX MATRIX MASTER**  
(Apple, IBM, and TRS-80)

COMPLEX MATRIX MASTER is very similar to MATRIX MASTER, but for complex (real plus imaginary) matrices. The real and imaginary parts of the matrix A'(I,J) are encoded into the BASIC matrix as follows:

Re A' (I,J) = A (I,2\*J)  
Im A' (I,J) = A (I,2\*J+1)

You may perform all the operations available in MATRIX MASTER.

Suggestion: If you deal only with real matrices, use MATRIX MASTER only; it consumes one-half as much memory and is slightly easier to use.

Price: \$39.95 Diskette (Single Precision)  
\$49.95 Diskette (Double Precision)  
\*not available for Apple

**POLYMASTER**  
(Apple, IBM and TRS-80 only)

POLYMASTER allows polynomial operations to be quickly and easily accomplished using symbolic statements like:

100 CMD POLY A = B+C

The operations available are +, -, \*, /, greatest common divisor, integral, evaluation, and setting one polynomial equal to another. Also included is a fast disk storage and retrieval utility.

Price: \$17.95 Diskette (Single Precision)  
\$25.95 Diskette (Double Precision)  
\* Double Precision not available for Apple

**THE MATH MASTER COLLECTIONS**

The entire MATH MASTER COLLECTION described above, including THE MATH MASTER EXECUTIVE, may be purchased in one of the following collections:

Price: \$129.95 Single Precision  
\$149.95 Double Precision

\* Double Precision is not available for the Apple

**ECM TURING MACHINE**  
(Apple only)

A Turing machine is the simplest operational model of the formal definition of computation. ECM TURING MACHINE portrays this concept in a way meaningful to students lacking an extensive background in computability.

The Turing machine has only five instructions, but can compute anything computable (within the constraints of available memory). ECM TURING MACHINE is composed of two parts. A set of state descriptions provides the instructions and controls the action performed under a given condition. A "tape" (a string of symbols) supplies the conditions for the state descriptions, and is the only input/output of the Turing machine. In the ECM version, there are 400 state descriptions.

ECM TURING MACHINE is not a programming language for developing applications software. There are better languages for doing this (e.g., BASIC, PASCAL). Rather, it is a fundamental teaching tool designed to instill an understanding of computability and appreciation of the logic behind computing.

For use in high school or college-level computer courses, or for personal instruction. Requires 48K and one disk drive. Includes a 65-page tutorial manual.

Price: \$49.95 Diskette

**STATE VARIABLES**  
(CP/M and IBM only)

STATE VARIABLES is designed to solve systems of ordinary differential equations (up to ten) which include a forcing function. For example, a network of RLC elements subjected to a varying input voltage can be easily analyzed. You may choose five types of forcing functions: a constant, ramp, step, sine wave, or user-defined function. The program then solves the problem and both prints and plots the resulting solutions (including derivatives). STATE VARIABLES is a very nice tool. Requires 48K, printer is optional.

Price: \$29.95 Diskette  
\$32.45 8" CP/M Disk

**DIFFERENTIAL EQUATIONS**

(CP/M and IBM only)

DIFFERENTIAL EQUATIONS is a series of programs which yield numerical solutions to ordinary differential equations given suitable initial conditions. Only two restrictions are placed on the differential equation being solved. First, it must be explicitly expressible in some sequence of the standard BASIC mathematical operators: +, -, \*, /, EXP, LOG, or the trigonometric functions SIN, COS, and ATN (or ATAN). Second, enough initial conditions must be provided to make the solution unique — that is, for an equation of order N, N simultaneous (at the same value of the independent variable) initial conditions must be known. Several different methods of solution can be chosen from, including Euler, Improved Euler, and Runge-Kutta techniques. An optional extrapolation routine provides improved accuracy for any data obtained. The results of any solution may also be plotted if desired. Output to a line printer is also supported.

Price: \$19.95 Diskette  
\$22.45 8" CP/M Disk

**BEWARE THE CHEAP DISKETTE!**

During the past year, the prices of diskettes have dropped remarkably. Also, in many cases, so has the quality. It looks like several well known manufacturers have lowered their costs (in an attempt to be competitive) by cutting corners in manufacturing.

From what we can tell, it looks like some companies are not polishing the media as well as they used to. Diskettes having dull magnetic surfaces, or ones showing blemishes or diagonal (chatter) marks should be avoided; they will haunt you!

For 5 1/4" diskettes, we are currently selling only one brand: Nashua. It is not unusual for DYNACOMP to run 10,000 Nashua diskettes through its duplication facilities and turn up only one bad diskette. Nashua diskettes are not only good, but they have the smoothest surface (as discussed in a BYTE Magazine product comparison), and, as we have found, have the highest reliability of all brands tested (and we have tested quite a few!).

Yes, you may be able to find cheaper diskettes, but they are cheaper, not less expensive (in terms of what you get for your money). DYNACOMP usually does not recommend one brand over another, but you should know that our production group loves Nashua diskettes!

- Mnemonic commands
- Dynamic display of the Simulation Time

ANALOG is supplied with a detailed manual which includes examples. It requires an 8080, 8085 or Z80 CPU with 64K of RAM, one disk drive, and a printer (very useful) which will print 120 or more columns. MBASIC is not required.

Price: \$ 99.95 Diskette  
\$102.45 8" CP/M Disk

**ANALOG**

(CP/M only)

ANALOG simulates the operation of an analog computer system on an 8080, 8085 or Z80 microprocessor.

Distinct advantages over an analog computer can be provided by using the microcomputer for continuous system simulation work. The output can be made directly available on hard copy. The configuration can be readily modified and a hard-copy record of all configurations can be maintained. The results are generally obtained more rapidly and less expensively than on an analog computer.

In ANALOG, the normal analog computer patch panel is simulated by specifying the interconnections between the 32 types of computational blocks available in this program. Through the use of the appropriate combination of these blocks, the response of any time-dependent system can be determined.

The program sorts the configuration blocks into a logical order that is appropriate and therefore the sequence and numbering of the blocks in the configuration is of no significance. The program user may order and number his (or her) blocks in any fashion he (or she) desires. The user may select either the 2nd or 4th order Runge-Kutta technique.

Some of the outstanding features of ANALOG are:

- Interactive control
- Dynamic configuration modification
- Dynamic initial condition and parameter modification
- Large simulation capacity with 250 elements or blocks
- Graphic and/or Printed numerical output
- Runge-Kutta integration
- Dynamic selection of 2nd & 4th order integration
- Automatically scaled graphics
- Menu driven
- File output for use with other programs
- Configurations may be developed on line and saved in a file
- 32 block types available
- Dynamic help level control
- 14 Primary commands
- Function generators with dynamic control
- Input in upper or lower case
- Low-resolution graphics output on any CRT or printer

**MATRIX 100**

(IBM only)

Although MATRIX 100 is in many ways similar to MATRIX MASTER, it contains some additional features and capabilities which appeal to the more sophisticated user.

MATRIX 100 adds new commands to BASIC (the syntax is almost identical to MATRIX MASTER). These allow:

- Matrix multiplication, addition, inversion, determinant, etc.
- Solving of linear equations.
- Multiple regression.
- Obtaining LU, QR factors, and solving.

In addition, you can examine regression statistics, numeric stability, etc. The package includes sample code to interactively solve linear equations and find eigenvalues (for real symmetric matrices).

MATRIX 100 is fast. It runs about 100 times faster than BASIC. The 8087 version (MATRIX 100/8087) runs more than 1000 times faster than BASIC.

MATRIX 100 requires IBM's BASICA (specifically), 128K of RAM, and one drive. To use MATRIX 100, you must be familiar with mathematical programming in BASIC. MATRIX 100 (for use with BASICA) Price: \$ 79.95

MATRIX 100/8087 (for use with BASICA, Price: \$119.95 8087)  
MATRIX 100/COMPILER VERSION (for Price: \$249.95 use with IBM's BASIC compiler — includes MATRIX 100 and MATRIX 100/8087)

**REVIEWER'S COMMENTS**

(Anthony Barcellos, PC Magazine, May 1985)

The 33-page MATRIX 100 user's manual is excellent. Beautifully typeset in multiple fonts for readability, it describes each command clearly, explains any options or parameters, and gives explicit examples.

The \$80 price is extremely reasonable.

After returning my review copy of MATRIX 100, I ... ordered a copy for myself.

**MORE REVIEWER'S COMMENTS**

(G. A. Kochenberger, OR/MS TODAY, Vol. 12, No. 1)

In summary, the package is both very powerful and very easy to use. I recommend MATRIX 100 to anyone doing work in BASIC.

**BIQUAD FILTER DESIGN TUTORIAL**

(Apple only)

BIQUAD FILTERS is another in the DYNACOMP electrical engineering tutorial series, and the product structure is the same: a two-part manual which describes the theory (with many examples) and program operation, and a graphics-oriented software package.

BIQUAD FILTERS not only teaches by example, but also allows the determination of the poles and zeroes required to produce various filters including:

- Analog anti-aliasing.
- Digital low pass, high pass, and band stop.

You may design Butterworth and Chebyshev low pass/high pass (up to 8 poles) and band pass (up to 4 poles) digital filters, and graphically observe both the analog and digital responses.

To use BIQUAD FILTERS, you must be familiar with the bilinear transform (an earlier tutorial in this series).

Includes a 31-page manual.

Price: \$29.95 Diskette

**CURVE FIT UTILITY**

(IBM only)

CURVE FIT UTILITY (CFU) fits curves to data. It provides flexibility in selecting curve types, data weighting factors, and data input/output devices and formats. CFU can be run stand-alone or can be used in conjunction with other software such as spread sheets, data bases, plotting packages, or other scientific or business applications software.

**FEATURES**

**Data Input** — Data for curve fitting can be input directly from the keyboard or it can be loaded from a disk file. A spreadsheet program, for example, can write data to disk which in turn can be read by CFU.

**Data Display and Edit** — Once the data is entered from the keyboard or disk, you have the ability to list and edit that data. Points can be added, deleted, or modified-as desired.

**Curve Fitting** — You can choose to fit to any of nine general curve types, with variations allowed within each type for a total repertoire of 32 mathematical functions. The nine general curve types are: linear, logarithmic, exponential, power, polynomial, constant to the x power, parabolic, Gaussian with linear trend, and sine. Two types of data weighting are also available.

**Curve Extrapolation** — Once the curve fit has been established, the user can supply "x" values and the program will calculate the corresponding fitted "y" values.

**Curve Output** — The curve fit parameters plus a calculated curve can be stored in a disk file. By this means, curve fit results can be passed on to other programs such as high resolution graphics plotters.

**Graphing** — The data and the curve can be graphed on the CRT or the printer. This is a primitive character plot intended only to let you visualize the data and curves generated by CFU. High resolution graphics is not used.

**Statistics** — The rms error and chi square are calculated.

CFU runs on any MS-DOS (or PC-DOS) machine with at least 192K of RAM. A printer is useful but not mandatory. All graphics are alphanumeric.

Price: \$29.95 Diskette

**FREE SERVICE CONTINUES!**

If you have a problem with a DYNACOMP program, CALL US! The help is free of charge.

Many companies charge for telephone help. For example, Adam Osborne's new software company bills \$1.00 per minute. We think that is unfair to the customer and speaks poorly of the industry!

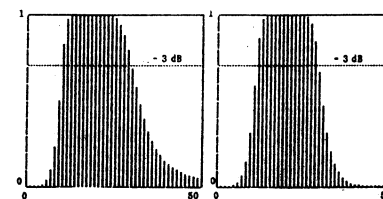

**OMNI-FIT**  
(IBM only)

OMNI-FIT is a curve fitting package with features and capabilities which place it midway between DYNACOMP's popular REGRESSION I/II and PARAFIT II.

The purpose of OMNI-FIT is to greatly simplify the task of fitting data to an equation form. OMNI-FIT provides the most common curve forms as menu-selectable options (linear regression, polynomial exact fit, polynomial least squares fit to order 8, exponential, power curve, cubic spline between neighboring points). OMNI-FIT can also fit data to forms defined by the user.

OMNI-FIT is menu driven and incorporates numerous user-friendly features such as single-keystroke menu selections, automatic datafile backup, automatic plot dimensioning, several hardcopy options, logarithmic and semi-logarithmic plots, etc. It will also integrate the fitted data or a user-defined curve. The derivative of the curve can be taken at any point and multiple roots of any equation or curve fit can be calculated. Graphical output supports both the IBM and the Hercules color cards.

**MAIN FEATURES:**

- Fits data to a wide range of equation forms.
- Provides standard deviation of curve fits.
- Integrates over a definite interval.
- Approximates first derivatives.
- Solves for the root or roots.
- Plots data or curves in linear, semi-log, or log form.
- Interpolates between data points based on best curve fit.

OMNI-FIT is not as fast or as "robust" as PARAFIT II, but it can handle most of the curve fitting problems commonly encountered. It also has exceptionally nice data editing and plotting features.

Price: \$49.95 Diskette

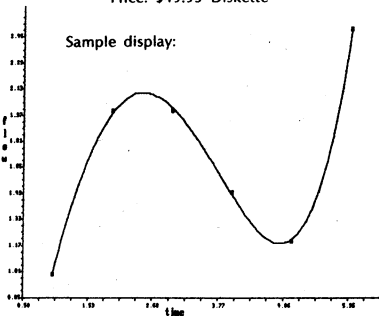
**FUNCTIONS**  
(Commodore 64 only)

FUNCTIONS may be used in a defined interval to find the roots, maxima and minima, the integral, derivatives, and to plot a graph of a function. The function may be either an expression or a finite power series (polynomial) read from a disk file. The expression may be up to 1,000 characters long and is easily entered from the keyboard. The power series may have up to 50 terms. You may predefine any recurrent constants, and specify the error bound for the results.

Integration is accomplished by the use of an adaptable integration scheme. It is performed using a fourth degree approximating polynomial, yielding more accurate results than using Simpson's rule.

For roots and maxima and minima, FUNCTIONS can fully explore user-defined intervals to search for multiple solutions. It can also quickly find single roots starting with an initial guess. In addition, derivatives of any order may be calculated at any point.

High-resolution screen displays are available. The axes may be placed anywhere, and the window user-defined.

Besides the usual mathematical functions available in BASIC, eight more have been added: two additional inverse trigonometric, three hyperbolic, and three inverse hyperbolic. These may all be used in the full (up to 1,000 characters) expression.

Includes a 26-page manual. A printer is supported.

Price: \$29.95 Diskette

Sample display:

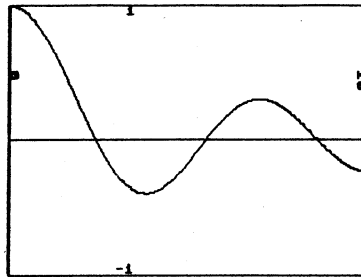
**LINEAR ALGEBRA**  
(Commodore 64 only)

LAL solves simultaneous linear equations, finds the determinant or the inverse of a matrix, and computes the product, the sum, or the difference between two matrices. It also has the ability to find the real eigenvalues. The corresponding eigenvectors are computed using the shifted inverse power algorithm. For further efficiency, the matrices are first transformed into their upper-Hessenberg form.

LAL also permits scalar multiplication, the shifting of the diagonal elements, the transposition of a matrix, as well as the creation of matrices of zeroes, of ones, identity matrices, or general matrices.

The data for the computations may come from the keyboard or from disk files. The result, if it is a matrix, may be filed to be used later for other operations.

Matrices may be easily reviewed, edited, and filed before the operations take place.

A printer is supported. Includes a 39-page manual.

Price: \$29.95 Diskette

**REGRESSION ANALYSIS II**  
(Commodore 64 only)

REG II performs bivariate or multivariate, linear or nonlinear regression analysis. It fits a user-chosen curve type to a given set of data points using the least-squares method, determines the regression coefficients, as well as the generalized correlation coefficient and the standard error of estimate. You may select the names of the variables to be used and predefine any recurrent constants, as well as review and edit the constants, functionals, and data.

Two types of disk files may be created or read: one with the data and the curve used, the other with the data only. These may be retrieved later to be expanded upon or edited.

A high resolution plot of the resulting regression curve and a scatter diagram are available. The axes may be placed anywhere and the window either user-defined or self-adjusting. The two plot modes enable you to view ordinary plots or, for example, log-log plots.

The individual mathematical functions available are the same as in FUNCTIONS. The length (1,000 characters) of the fitting expression gives ample room, and very complicated expressions, both linear and nonlinear (with nonlinear cross terms, etc.) may be fitted. Data values may be later interpolated/extrapolated.

A printer is supported. Includes a 27-page manual.

Price: \$39.95 Diskette

Sample display:

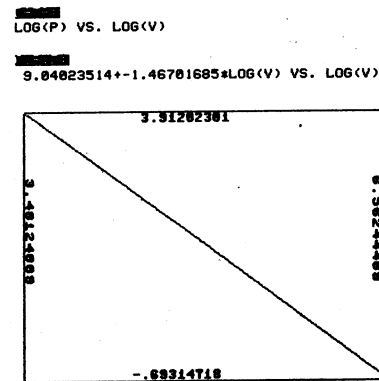
**NONLINEAR SYSTEMS**  
(Commodore 64 only)

NLS solves systems of simultaneous linear and nonlinear equations to user-specified error limits. You may select the names of the variables to be used and predefine any recurrent constants.

NLS can also fully explore defined intervals to search for multiple solutions. It also can quickly find single solutions starting with an initial guess. Equation entry is identical to FUNCTIONS, with the same flexibility and capability. This is true for each equation.

A printer is supported. Includes a 21-page manual.

Price: \$29.95 Diskette

**LINEAR ORDINARY DIFFERENTIAL EQUATIONS**  
(Commodore 64 only)

LODE solves boundary value problems involving linear ordinary differential equations of any order, with variable coefficients. The boundary conditions may also be equations involving the unknown function and its derivatives, and the evaluation point may be different for each one.

The differential equation and each boundary condition may be an expression up to 1,000 characters long, and are entered directly from the keyboard using an easy operator syntax.

The solution produced is a continuous function in the form of a finite power series valid in the entire defined interval and expanded about a chosen center of expansion. Up to 50 terms may be included in the series. A high resolution screen plot of the solution is available. The axes may be placed anywhere, and the window user-defined.

The solution may be stored in a disk file which may be later read by a suitable program (like FUNCTIONS) to further study it to find its roots, maxima and minima, derivatives, and integral.

The functions available for use in the equations are the same as in FUNCTIONS.

A printer is supported. Includes a 23-page manual.

Price: \$29.95 Diskette

```
[X*012+2*0]Y=48*X*X-16*X-14
[ ]Y=1
[ ]Y=-1
```

```
ORDER = 2
# OF TERMS = 7
INTERVAL: [-2, 3 ]
CENTER OF EXPANSION: XC = 0
EXPANSION COEFFICIENTS:
Y( 0 ) = 1
Y( 1 ) = -7
Y( 2 ) = -3
Y( 3 ) = 4
Y( 4 ) = 0
-Y( 5 ) = 0
Y( 6 ) = 0
```

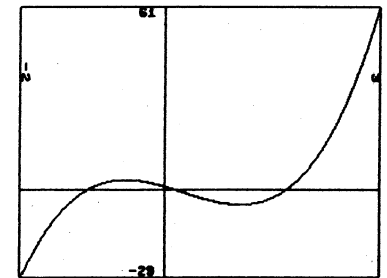
**MATHEMATICS COLLECTION**  
(Commodore 64 only)

The six-diskette series, FUNCTIONS, NONLINEAR SYSTEMS, MULTIPLE INTEGRATION, LINEAR ORDINARY DIFFERENTIAL EQUATIONS, REGRESSION ANALYSIS II, and LINEAR ALGEBRA, may be purchased for a combined price of \$129.95.

Sorry, but collections cannot be used in or towards DYNACOMP's 10%-20% volume discounts.

**PC MATH PACKAGE**

(Apple only)

PC MATH PACKAGE is a collection of routines that allow you to use the Apple to do calculus operations. The **plotter** portion will graph both normal and parametric (a unique feature; you enter the equations for X(T) and Y(T)) equations. The program prompts you for the equations, and you simply type them in. These equations may be plotted in standard Cartesian coordinates or polar coordinates. Also, one or both axes may be logarithmic rather than linear. You have total control over the scaling of the graph, or the program will automatically scale for you if you wish. Functions may be plotted on a blank screen, or on the axis or grid for enhanced readability. Multiple functions may be plotted simultaneously, and five colors may be chosen to help differentiate between each. You may also choose to "fill" below curves. Also included is a labeling program, with which each graph or set of graphs may be labeled. Pictures created with the plotter may be saved to disk for future use. All of the standard functions are available, including SIN(X), COS(X), EXP(X), ARCCOS(X), COSH(X), etc. (38 in all; more can be added by the user). Also, the inverse, derivative, and integral of the function can be calculated and displayed. Included along with the plotter is a program to analyze a function for min/max and roots.

PC MATH PACKAGE is aimed at people interested in performing calculus on the computer. It is particularly useful to high school or college instructors as a teaching aid, and also to students interested in experimenting with calculus on their own. The plotter segment is a valuable aid for those wanting to graph sets of data easily and quickly, either for school or business.

Requires a 48K Apple II+, IIc, or IIe with one drive.

Price: \$49.95 Two Diskettes

Sample Screen Dumps:

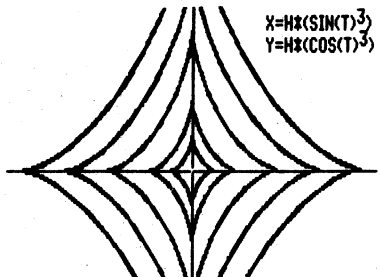
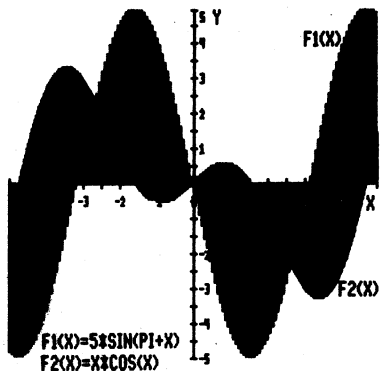

**MATH PACK**

(Apple and IBM only)

If you're a student, teacher, mathematician, engineer or scientist in search of mathematical analysis routines, this package is for you. Elegantly written and user-oriented, this group of four programs makes maximal use of HI-Resolution plotting capabilities to augment math routines and display the results. The program contains a master menu to run any one of the following programs:

**Statistical Analysis:** A general purpose menu-driven statistics package that allows the user to analyze numerical data bases. The program computes and displays:

- Simple Linear Regression Line
- Mean
- SLR Equation Coefficient
- Standard Deviation
- Frequency Distribution Plot
- Data Points

Included are routines for disk data file I/O, editing and printer output.

**Numerical Analysis:** This program will plot any two variable equations that you can write using standard Basic arithmetic functions. The program will plot the equation, its integral, and its derivative. It will determine and list roots, maxima or minima encountered and the integral value over the plot range.

**Matrix:** This program allows you to solve for the inverse, determinant and solution matrix for linear systems of up to 54 equations in 54 unknowns. It uses standard Gauss elimination with pivoting for maximum efficiency. Included are standard data-base management routines for editing, disk I/O and printer reports of both data and results.

**3D Surface Plotter:** This program does general purpose 3-D plotting of any 3 variable equations that you can write using standard BASIC arithmetic functions. It performs either hidden-line or transparent plots. Disk I/O routines are included for saving plot pictures on diskette.

The programs are all menu-driven and employ extensive prompting for easy use. The entire series of programs is supplied on a single disk together with demos and an instruction manual.

Requires 48K (Apple), 64K (IBM).

Price: \$49.95 Diskette

Sample display (Surface Plotter):

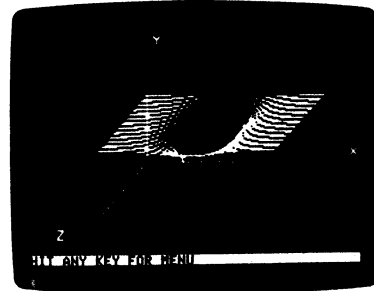

**FOR THE BEST PRICES ON EXCELLENT QUALITY DISKETTES, SEE OUR SUPPLIES SECTION. WE DO NOT SELL THE REJECTS, SECONDS, OR REDUCED SPECIFICATION DISKETTES WHICH ARE NOW BEING SOLD AT "AMAZINGLY" LOW PRICES. THEY ARE NOT SO AMAZING IN QUALITY!**

**PC GRAPHICS**

(IBM only)

PC GRAPHICS is an integrated graphics package designed for both engineering and educational applications. With PC GRAPHICS you may graph XY and XYZ coordinate equations, as well as parametric and polar equations. Experiment with data while maintaining control over scaling, position of the origin, interval, and increment for the dependent variable(s), etc. You may even determine relative maxima and minima, solutions to polynomial equations, intersection points, etc.

It is easy to set up multi-line functions using a BASIC-like syntax. Example:

```
IF X < 0 THEN Y = X^2 ELSE Y = SIN(X)
```

In addition to being able to send a graph to a graphics printer without distortion, you can save 9 screens on each data diskette; three from the XY-coordinates grapher and two from each of the other three systems. The multiple screen saving capability is particularly useful if you wish to prepare graphs in advance for a later presentation.

Other features include:

- You can imbed up to three parameters in your equations. These values can be varied as part of your multi-line function, or from the keyboard.
- Plot colors can be changed between parameter changes.
- Intersection points are displayed; you can zoom in on them if desired.
- XY axis can be rotated.
- XYZ (3-D) plots can be rotated at will about the Z axis (very useful!).
- An unlimited number of graphs can be overlaid on the same coordinate system.
- Variable magnification (up to one million) centered on any point.
- Variable demagnification (up to one million).
- Up to 16 relative maxima/minima can be shown, even if the region is not within the screen.
- Automatic decimal (ones, tens, etc.) calibration of axes.
- 3-D hidden line removal is selectable, upper/lower surfaces in different colors, can be shown separately, etc.

The 50-page manual also includes information on advanced applications, such as how to graph discrete sequences, recursively defined functions, functions in the complex plane, etc. PC GRAPHICS is both powerful and versatile, and can be used in a mathematics class as well as in engineering applications requiring visual representations of functions.

Requires 128K of RAM, color graphics. A printer is supported.

Price: \$49.95 Diskette

Sample display:

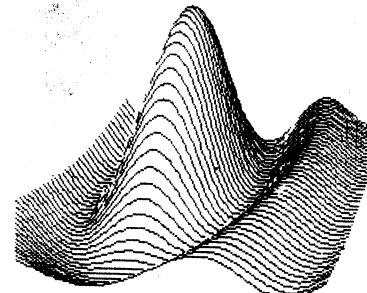

**THE SYNTEL MATH TOOLBOX**

(IBM only)

The TOOLBOX is a powerful programmable calculator that enables you to do sophisticated mathematical calculations easily. You enter arithmetic statements as you would normally write them and then, with a keystroke, ask the TOOLBOX for the answer. The TOOLBOX includes a complete set of built-in trigonometric, logarithmic, and exponential functions. It also has a powerful programmable feature. You can define your own functions and then provide parameter values for these functions for solution. You can save all your computations on a disk file and load them back.

The GRAPH command is a flexible tool for creating visual representations of mathematical functions. You can create a variety of graphs.

Features:

- Character/Bit-map Graphs. Draws graphs in character as well as bit-map mode.
- Tables. Generate numeric tables of functions, to the desired precision. By using the table feature in conjunction with the plotting capability, you have the ability to do all kinds of scientific plotting.
- Graph Labeling. Enter labels, titles, and legends to graphs. The TOOLBOX lets you write anywhere in the graphics space with a full-screen editor.
- Automatic Scaling. Automatically choose optimal numeric scales so that the graph fits the data. You can also set scales manually to produce particular visual effects.
- Graph Printing. Print out the graph immediately on your C. ITOH or EPSON printer.
- Two basic statistical functions, linear regression and standard deviation. The input data along with the linear regression line can be plotted.

Requires 128K, a graphics card, and one disk drive.

Price: \$39.95 Diskette

**IBM OWNERS,  
BUY THIS IF NOTHING ELSE!**  
(IBM only)

DYNACOMP is distributing two exciting MS-DOS utilities which are really super and which we strongly recommend.

The first, MEDIA MASTER, allows you to read a huge number of different CP/M and MS-DOS format diskettes (e.g., Osborne, Kaypro, Xerox, Morrow, and so on). The second, ZP/EM, allows you to run almost all CP/M .COM programs that do not do anything special with the hardware. For example, MBASIC.COM (Microsoft BASIC) can be moved from a CP/M diskette to your MS-DOS diskette using MEDIA MASTER, and then run using ZP/EM. This opens up a whole new realm of CP/M software to MSDOS computers!

MEDIA MASTER and ZP/EM are described elsewhere in this catalog. You may purchase them as a collection for \$59.95 (under the name of MEDIA MASTER PLUS), which is an amazingly low price for a product which does so much.

Examples: DYNACOMP's HEAT LOSS, REFERENCE, MONEY, KEEP TRACK OF IT, and ANALOG programs come on CP/M diskettes (e.g., KAYPRO II). Using MEDIA MASTER PLUS you can run these on your IBM!



**BASIC SCIENTIFIC SUBROUTINES  
VOLUME I**

(available for all computers)

BASIC SCIENTIFIC SUBROUTINES, VOLUME I by F. Ruckdeschel (published by BYTE/McGraw-Hill; see the January 1981 issue of BYTE Magazine, page 173) is the first in a series of books designed to provide microcomputer users with scientific subroutines written in BASIC. These subroutines have been designed to facilitate the application of microcomputers to scientific tasks which have previously been largely in the domain of the large timeshare mainframe computers.

Through arrangements with the author and BYTE/McGraw-Hill, DYNACOMP has become the exclusive distributor of three software packages keyed to the above text. Each package includes programs organized by chapter and accessed/demonstrated by a special menu program written especially for DYNACOMP. Unlike other software packages commercially available which are keyed to texts, you do not have to search the tape (diskette or disk) to load a particular program. They are all loaded in one step and are called according to the menu selection. This makes life much easier for the user.

Because of the total length of the software listed in the text (greater than 33 kilobytes), three collections have been organized. Each collection will run in 16K of program memory space (Atari requires 32-48K).

**Collection #1:**

**Chapter 2 - Alphanumeric Data Plotting**

- Equally Spaced Data
- Arbitrarily Spaced Data

**Chapter 3 - Complex Variables**

- Polar Coordinate Conversion
- Addition, Subtraction, Multiplication, Division
- Powers and Roots
- Spherical Coordinate Conversion

**Collection #2:**

**Chapter 4 - Vector and Matrix Operations**

- N-vector Addition, Subtraction, Multiplication (dot and cross products)
- N-vector Lengths
- Angles Between Vectors
- Matrix Addition, Subtraction, Multiplication, Transposition, etc.
- Row Operations
- Cofactors, Determinants
- Inversion
- Eigenvalues
- Exponentiation

**Collection #3:**

**Chapter 5 - Random Number Generators**

- Uniform, Normal, Poisson, Binomial
- Exponential, Fermi, Cauchy, Gamma Beta
- Weibull

**Chapter 6 - Series Approximations**

- Sine, Cosine, Arctangent
- Natural, Base-10 Exponent and Logarithm

Price: \$16.95 per collection (Cassette)  
\$20.95 per collection (Diskette)  
\$23.45 per collection (8" Disk)

Accompanying each collection is documentation which describes how to use the associated menu program. Detailed descriptions of the programs, input/output parameters, and the algorithms employed in the subroutines are to be found in the McGraw-Hill text BASIC Scientific Subroutines, Volume I (316 pages) which DYNACOMP also distributes (\$29.95 plus \$2.00 extra for postage and handling). We strongly recommend this book. The three collections may be purchased for a combined price of \$44.95 (3 cassettes), \$53.95 (3 diskettes) or \$59.95 (3 IBM 3740 format disks).

**Basic Scientific Subroutines - Prices\* by Chapter**

Volume	Chapter							
	1	2	3	4	5	6	7	8
Volume I	X	<--- 20.95 --->		20.95	<--- 20.95 --->		X	X
Volume II	\$18.95	\$18.95	\$18.95	\$18.95	\$18.95	\$18.95	\$18.95	\$18.95
Volume III	\$29.95	\$29.95						

\*Single Density. Add \$3.00 per diskette for Double Density. Add \$2.50 per disk for 8-inch IBM 3740 format.

**BASIC SCIENTIFIC SUBROUTINES  
VOLUME 3, CHAPTER II**

**BASIC SORTING SUBROUTINES**

(Available for all computers except Atari)

There have been so many requests for the third volume of the BASIC SCIENTIFIC SUBROUTINES series that the author has decided to supply the chapters and sections as they are finalized. The entire book has been written, but each chapter is being reworked to ensure compatibility with Volumes 1 and 2, as well as with the other Chapters in Volume 3.

Volume 3 is basically a text dealing with statistical subroutines, including data handling. The second chapter is concerned with numeric and alphanumeric ("alphabetical") sorting. This topic was chosen for an early chapter because data usually has to be ranked, ordered or separated before any quantitative analysis can ensue.

Seven (actually, fourteen; seven for numeric arrays; seven for alphanumeric arrays) sorting routines are discussed:

1. The bubble sort

2. The insertion sort
3. The Shell sort
4. The Shell-Metzner sort
5. The Butterfly-Hart sort
6. The heap sort
7. The quick sort

Each has advantages and disadvantages in terms of speed under certain sorting conditions, code length, array memory requirements, and equal element exchanges (a very important property which is usually overlooked).

Also included in this chapter is a program for accurately calculating moments (e.g. mean, variance).

The subroutines are presented in the same REMarked format as is the pattern in the other volumes. There are demonstration programs for showing how they operate, timing comparisons, input/output descriptions, variables list, etc. In other words, these programs are fully commented and documented in the same way which has made Volumes 1 and 2 so popular.

The package is composed of the disk(ette) containing the subroutines and demonstration programs, and a preprint of Volume 3, Chapter II (over 160 pages).

Price: \$29.95 Diskette  
\$32.45 8-inch CP/M Disk

**BASIC SCIENTIFIC SUBROUTINES  
VOLUME II**

(Available for all computers)

This is the second set in the continuing scientific software series (see the discussion associated with Volume I). This volume contains more than 120 kilobytes of excellent software. As with Volume I, the software is divided up into collections, with each collection having its own menu program for calling up and demonstrating the subroutines. Each of the eight collections is keyed to a chapter in the book:

**Chapter 1 - Least Squares Approximation**

- First-Order Least Squares
- Second-Order Least Squares
- Nth-Order Least Squares
- Multidimensional Least Squares
- Least-Squares Fitting with Orthogonal Polynomials
- Iterated Regression
- Parametric Least Squares

**Chapter 2 - Series Approximation Techniques**

- Taylor Series and Horner's Rule
- Asymptotic Series
- The Bessel Function
- The Chi-Square Distribution Functions
- The Gamma Function
- The Error Function
- Chebyshev Polynomials
- Economization
- Polynomial Reversion
- Polynomial Inversion
- Shifting the Expansion Point
- Rational Polynomials
- Infinite Products
- Complex Series

**Chapter 3 - Functional Approximations by Iteration and Recursion**

- Roots of Iteration
- Tangent Iteration
- Arc tangent by Recursion
- Arc sine by Recursion
- Elliptic Integrals by Recursion
- Natural Logarithm by Recursion
- Bessel Functions by Recursion
- Orthogonal Polynomial Coefficients by Recursion

**Chapter 4 - CORDIC Approximation Techniques and Alternatives**

- The Trigonometric Functions
- Generating the T. and P. Coefficients
- The Inverse Trigonometric Functions
- The Exponential Function
- The Natural Logarithm Function
- The Hyperbolic Trigonometric Functions
- Inverse Hyperbolic Trigonometric Functions

**Chapter 5 - Table Interpolation, Differentiation, and Integration**

- Lagrange Interpolation
- Newton Divided-Differences Interpolation and Error Estimates
- Choosing the Table Values
- Semi-Spline Interpolation
- Calculating Derivatives from Tables
- Table Integration
- Interpolation and Integration of  $2/\sqrt{2\pi} e^{-x^2}$

**Chapter 6 - Finding the Real Roots of Functions**

- Gaining Preliminary Knowledge About the Roots of a Polynomial
- Interval Searches
- Successive Substitution
- Newton's Method
- The Secant and False Position Methods
- Aitken Acceleration
- Aitken-Steffenson Iteration
- Finding More Roots: Multiplicity
- Finding More Roots: Removal

**Chapter 7 - Finding the Complex Roots of Functions**

- Interval Search
- Newton's Method in the Complex Domain
- Mueller's Method in One Dimension
- Two-Dimensional form of Mueller's Method
- Mueller's Method in the complex Plane
- Representing Polynomials in the  $u(x,y) + i v(x,y)$  Form and Removing Roots
- The Quadratic Formula
- Lin's Method
- Bairstow's Method

**Chapter 8 - Optimization by Steepest Descent**

- Steepest Descent with Functional Derivatives
- Steepest Descent with Approximate Derivatives

Price: \$14.95 per collection (Cassette)  
\$18.95 per collection (Diskette)  
\$21.45 per collection (8" Disk)

Accompanying each collection is documentation which describes how to use the associated menu program. Detailed descriptions of the programs, input/output parameters, and the algorithms employed in the subroutines are to be found in the McGraw-Hill text BASIC Scientific Subroutines, Volume II (790 pages) which DYNACOMP also distributes (\$29.95 plus \$2.00 for postage and handling). We strongly recommend this book. The eight collections may be purchased for a combined price of \$99.95 (8 cassettes), \$129.95 (8 diskettes), or \$144.95 (8 IBM 3740 format disks).

See the reviews of BASIC Scientific Subroutines appearing in Kilobaud and Dr. Dobbs.

**BASIC SCIENTIFIC SUBROUTINES  
Volume 3, Chapter 1**

**BASIC PROBABILITY DISTRIBUTIONS**

(Available for all computers except Atari)

Chapter 1 of Volume 3 includes the introduction to Volume 3 as well as a coordinated set of subroutines for calculating the probability density, cumulative distribution, and inverse cumulative distribution (for hypothesis testing) for the following probability functions:

1. Normal
2. Student's T
3. Chi-Square
4. Poisson
5. Snedecor F

These subroutines essentially replace and improve upon the standard statistical tables used for setting confidence limits and testing hypotheses.

Each subroutine is supported by a demonstration program which allows you to calculate either a specific value, or to display entire tables. Alternatively, you may include these routines in your own programs so that you need never again consult printed tables or have to interpolate.

As has been the tradition with the BASIC SCIENTIFIC SUBROUTINES series, these routines are REMarked and carefully documented (variables, functions used, input/output variables; subroutine connection diagrams; restrictions, precautions, descriptions, sample runs, listings, etc.).

19 Subroutines  
15 Demonstration Programs  
36K of Code; 1600 lines  
210-page Manual (perfect bound)  
Requires at least 32K of RAM

Price: \$29.95 Diskette plus Manual  
\$32.45 8-inch CP/M Disk plus Manual  
\$12.95 Manual only

## DIGITAL IMAGE PROCESSING

(Apple Only)

DIGITAL IMAGE PROCESSING (DIP) is a must for any scientist, engineer, student, photographer, or experimenter interested in the digital representation of images. This two-diskette package allows you to digitally manipulate images (15 samples are supplied, including pictures of Lincoln, Kirchoff, and Saturn) to remove interference, noise, improve contrast, sharpen, and generally filter images.

The manual is broken into two main sections. The first describes the theory associated with digital filtering, including histogram correction. The second half of the manual deals with the HI-RES graphics examples and routines which demonstrate the various ways in which an image can be analyzed and altered.

DIP is HI-RES graphics and menu-oriented. Images (e.g. before and after) can be displayed on a standard TV screen or an oscilloscope. (Optional: The schematic for a simple oscilloscope interface to fit in Slot #3 is given. It uses three Analog Devices AD558 D/A converters). All images can be stored and recalled individually for later viewing.

The experiment menu includes processing examples (you run them with your own parameters) for over- or under-exposure (you will see how effective histogram correction is for this!), noise, interference, double exposure (you are given two different double-exposure pictures to try to rescue) and poor contrast.

Each image may be manipulated in the following ways:

1. Gamma correction (you choose the gamma).
2. Inversion (good for making slides).
3. Histogram correction (very powerful).
4. User-supplied non-linear contrast correction (you supply the table look-up).
5. Digital filtered (you supply the filter function).

The fifth mode has several alternatives. You may filter in the X, Y, or XY directions using moving average filtering and combined thresholding and gradient enhancement ("unsharp masking" in photography). You may also specify the filter in terms of poles and zeroes on the transfer function (see also the EDUCATION section under Z-TRANSFORM TUTORIAL, DIGITAL FILTER DESIGN TUTORIAL, and BILINEAR TRANSFORM TUTORIAL).

The manual concludes with a list of experiments to try in order to get a "feel" for the utility of the many tools at your disposal. Learn by doing.

Requires 48K, one disk drive. Oscilloscope optional (requires interface).

Price: \$59.95 Two Diskettes

Sample display:

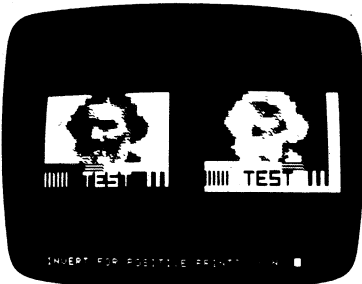

**COLLECTIONS:** The three-package DIGITAL IMAGE PROCESSING set may be purchased as a collection for \$149.95. Sorry, collection prices cannot be further discounted or used in or towards DYNACOMP's 10%-20% quantity discount.

## DIGITAL IMAGE PROCESSING II

(Apple Only)

DIGITAL IMAGE PROCESSING II (DIP II) is a follow-up to the first package, DIP. It provides a means for converting 57344-pixel, bit-mapped images into 8192- and 2048-pixel seven-level digital images. The converted image can be displayed on the screen with a representation of the video signal shown as an insert, or sent to an oscilloscope (see DIP description). The diskette includes four HIREs pictures on diskette.

Price: \$15.95



## DIGITAL IMAGE PROCESSING III

(Apple only)

(Includes assembled parts for a low-cost image scanner and SCAN-A-PICTURE.)

DIGITAL IMAGE PROCESSING III (DIP III) is for those who have graduated from DIP and DIP II and would like to go further in image processing. In many ways, DIP III ties together ideas from the various other engineering tutorials (see EDUCATION-ENGINEERING section) involving transforms and digital filtering. With DIP II, you can get hands-on experience in the following areas:

- Gamma correction
- Histogram correction
- Look-up table correction
- Image smoothing, differentiation
- Template matching
- Image scanning

Also, you may repeatedly zoom in on an image; segment it; invert it; create mosaics; graphically see the gray-scale correction; convert 2K-pixel X 8-level "halftone" images to 8K-pixel X 1 (bit mapped) images; sharpen; smooth (5,9 point); threshold; and much more. Output may be directed to either the TV screen or to an oscilloscope (see DIP for a discussion of this feature).

DIP III comes with many images on disk to serve as examples as well as image data for processing. In addition, you may scan your own images (transparencies) and process them. You may do this with a simple photo-resistor/transistor sensor device which connects to the Apple through the paddle socket. DYNACOMP supplies all of the parts necessary (comes assembled and tested), a transparency for experimentation, and operating instructions. With this device and the software included in DIP III (SCAN-A-PICTURE), you may "capture" your own 2048-pixel X 8-bit images, histogram correct, invert, etc. DIP III comes complete with a 42-page main manual (containing both theory and program instructions, an assembled and tested photoresistor/transistor sensor system, including socket, and an experimenter's manual.

Requires 48K, and one disk drive. An oscilloscope is optional (not necessary). Experience level necessary: Moderate. Familiarity with DIP and DIP II is suggested. Using DIP III is easy, but be prepared to experiment with light levels, sensor positioning, etc.

Price: \$99.95 Diskette & Sensor System

### THE ADAM OSBORNE SOFTWARE COLLECTION

(Available for all computers except Atari)

Here are four collections of programs keyed to the text *SOME COMMON BASIC PROGRAMS* published by Adam Osborne, (book written by Poole and Borchers). These collections received 10 (out of 10) ratings in our North Star Software Exchange listing. They have been translated to other machines covered by DYNACOMP and are an *absolutely excellent bargain*.

The DYNACOMP versions come with a master menu which allows you to easily choose the program desired, execute it, and return to the menu. The DYNACOMP versions have also been significantly *improved and corrected*. The programs are generally self-prompting. Although the documentation from DYNACOMP is sufficient for most applications, it is suggested that you obtain the associated Osborne book. This book is so popular that most computer stores carry it, or you may order directly from Osborne/McGraw-Hill.

The four sets are:

## COLLECTION #1:

Price: \$12.95 Diskette  
\$15.45 8-inch CP/M Disk

## SOME COMMON BASIC MATH PROGRAMS DISK A

1. Greatest common divisor
2. Prime factors of integers
3. Area of polygon
4. Parts of a triangle (radians)
5. Parts of a triangle (degrees)
6. Analysis of two vectors
7. Operations on two vectors
8. Angle conversions (degrees to radians)
9. Angle conversions (radians to degrees)
10. Coordinate conversion
11. Coordinate plot
12. Plot of polar equations
13. Plot of functions
14. Linear interpolation
15. Curvilinear interpolation

## COLLECTION #2

Price: \$12.95 Diskette  
\$15.95 8-inch CP/M Disk

## SOME COMMON BASIC MATH PROGRAMS DISK B

1. Integration — Simpson's rule
2. Integration — trapezoidal rule
3. Derivatives
4. Roots of equations (Newton half-interval)
5. Trigonometric polynomials
6. Simultaneous equations
7. Linear programming
8. Matrix operations

## ATARI XL TRANSLATOR

(Atari XL only)

The new Atari XL series of computers has certainly created a good deal of excitement. It has also generated quite a bit of confusion!

Almost all of DYNACOMP's software for the "old" Atari will run on the new XL's. The only ones that have difficulty are just a few of those which use the disk for data storage and retrieval. The typical problem is as follows: after some time the program stops with a 162 error (disk full). However, when you look at the directory, there are 40 to 50 blocks free! Very few people are getting this error.

## COLLECTION #3

Price: \$12.95 Diskette  
\$15.45 8-inch CP/M Disk

## SOME COMMON BASIC STATISTICAL PROGRAMS

1. Permutations and combinations
2. Mann-Whitney U-test
3. Mean, variance, and standard deviation
4. Geometric mean deviation
5. Binomial, Poisson, Normal, Chi-square distribution.
6. Chi-square test
7. Student's t-distribution and test
8. F-distribution
9. Linear correlation coefficient
10. Linear regression
11. Multiple linear regression
12. Nth order regression
13. Geometric, exponential regression
14. System reliability

## COLLECTION #4

Price: \$12.95 Diskette  
\$15.45 8-inch CP/M Disk

## SOME COMMON FINANCIAL PROGRAMS (and MISCELLANEOUS PROGRAMS)

1. Average growth rate, future projections
2. Tax depreciation
3. Recipe cost
4. Map check
5. Day of the week
6. Days between two dates
7. Anglo to metric
8. Future value of investment, regular deposits
9. Regular deposits, withdrawals
10. Initial investment
11. Nominal, effective interest rate
12. Earned interest
13. Depreciation rate, amount
14. Salvage value
15. Discount commercial paper
16. Principal, regular payment, last payment on loan
17. Remaining balance, term, annual interest on loan
18. Mortgage amortization table
19. Alphabetize

REMEMBER, these are not full commercial-grade programs; they do not contain extensive file manipulation procedures, etc. However, you do get a lot to work with! Also, you must have BASIC (not just CP/M) to run these programs.

## PRICE NOTES:

1. The entire collection is available for \$39.95 for four diskettes or \$49.95 for 4 8-inch CP/M disks.
2. We have priced these collections too low to allow them to be included in quantity discounts. Sorry!
3. The diskette prices above are for single-density. For each double-density diskette, add \$3.00.

**CELESTIAL BASIC**

(Apple, C-64, and IBM only)

Ever wished you had a planetarium at home? Ever wanted to check the positions of the planets or Jupiter's satellites, or time in the past or future when you did not have an almanac for that time? Or wanted quick access to some data about a planet or one of its satellites?

Eric Burgess, F.R.A.S. has developed a series of programs to answer these needs and has also written a book to accompany them, called *Celestial Basic*. We can best describe the quality of the program by quoting Arthur C. Clark (author of 2001: A Space Odyssey): "I have run them [the Celestial Basic programs] on my Apple II and am overawed by the work and skill that must have gone into them."

Ascent to Orbit published by John Wiley and Sons

So much for the praise; now for the contents—

**Moon and Planet Programs (Disk #1)**

- Right Ascension and Declination – provides the approximate right ascension and declination of the moon for any date and time.

- Umbral Eclipses – for a start date of any year, this program tells you when the next umbral eclipse of the moon occurs, gives the magnitude of the eclipse, the local time of mid-eclipse, and the rise and set times of the moon for the day of the eclipse.

- Dates and Times of Lunar Phases – provides a table of lunar phases for any month with the choice of local or universal time for the phase.

- Right Ascension and Declination of the Planets – is divided into three parts. The first gives the right ascension and declination based on the 1960 epoch and using the equation of the center. The second gives more accurate right ascension and declination based on the 1980 epoch and uses Kepler's equation. The third gives hard-copy printout of the 1980 epoch data. Each also provides angular distance from the sun and distance in astronomical units from the Earth.

- Planets/Sun/Moon Finder – This program helps you locate the planets, sun, and moon relative to the stars for any date. The program calculates the position of the object and selects a star map for the appropriate part of the sky, shows the constellations, and plots the chosen planet (or the sun or moon). It also plots other planets in the same region of the sky. You may plot a series of intervals to show the motion of the planet across the star field.

- Planets/Sun/Moon Rise and Set Times – provides times when the planets, sun, and moon rise, transit, and set for any location on Earth, for any date.

- Mars Oppositions – This program offers two alternatives: The first finds the next opposition of Mars. The program asks for a start year and month, displays a plot of sun, Earth and Mars seen from above the solar system, counts off month by month and in smaller time intervals as opposition approaches, until the date of opposition, and then provides details such as angular size, constellation Mars is in, distance from Earth, and so on. The second alternative provides observational data about Mars for any date.

- Mercury and Venus – has three sections: The first tells you when the next eastern or western elongation of either Mercury or Venus occurs after a selected date, and provides information about the planet selected. The second shows graphically how Mercury and Venus swing from side to side of the sun. The third is used to find out when it is best to observe Mercury and Venus at any date and for any locality by indicating the rise times before and after the sun.

- Jupiter's Satellite Configurations – For any date, location, and time, this program provides data on the configuration of the Galilean satellites of Jupiter and makes a graphic display of the configuration.

- Worldwide Horizon Plots – An advanced graphics program which allows you to display the night (or day) sky on the monitor of your computer for any time and date and any location on Earth. In addition, the program displays Halley's comet for the 1910 and 1986 apparitions for times when it is expected to be visible in amateur telescopes. The tail is sized and oriented as expected. A planetarium-type horizon silhouette is displayed on each skyplot. You can select north, south, east, or west horizons, each of which overlaps those on either side and covers 180 degrees of azimuth. This is the most advanced and realistic skyplot program available today and it is updated to 1980 coordinates.

**Time and Tutorial Programs (Disk #2)**

- Sidereal and Mean Time Conversion

- Julian Day from Calendar Date

- Updating Star Coordinates – provides right ascension and declination for any epoch given the right ascension and declination at another epoch.

- Transits of Pole Star – provides the time for any date when Polaris transits the meridian and is at eastern and western elongation.

- Astronomical Conversions – provides rapid conversions of astronomical measurements including: light years, parsecs, astronomical units, telescope resolving power, and metric units.

- Dates of Meteor Showers – provides details of annual meteor showers for any calendar month and shows a graphic star chart for you to identify the point from which the meteors appear to radiate (the radiant).

- Solar System Data – a long program, loaded with information about the solar system, its planets, and their rings and satellites.

- Recognizing the Constellation – a tutorial program which teaches you to recognize the constellations in the night sky. Bright stars in many constellations are also presented for you to identify.

- Photographing the Planets – You are asked to identify your photo configuration – camera at prime focus, camera with eyepiece, or projection with eyepiece – focal lengths involved, and aperture of objective mirror or lens, film speed, and planet being photographed. The program provides advice on size of image obtained and exposure needed.

NOTE: The IBM version comes on one disk and requires a color graphics card.

Price: \$49.95 Two Diskettes  
 \$13.95 Book alone  
 \$59.95 Book and 2 Diskettes



**STAR CAL III**

(IBM only)

Keep informed of coming celestial events using the monthly sky calendar provided by STAR CAL II. Choose any month during 1984 to 1990 inclusive and an organized table of important astronomical phenomena is immediately displayed on the video screen. Events covered include:

- phases of the moon
- lunar and solar eclipses with terrestrial locations for viewing
- Oppositions of Mars, Jupiter, and Saturn
- east and west greatest elongations of Venus
- annual meteor showers (with expected hourly rate)
- culmination of 85 constellations (point at which they reach highest point above horizon)
- miscellaneous events (such as oppositions of Vesta, the largest asteroid)

For weekend astronomers, all dates include the day of the week. The calendar's layout shows at a glance if the moon will be favorable for night viewing.

STAR CAL II also provides a real-time astronomical clock, keeping time in the following 6 standards:

- local standard
- local daylight
- local civil
- local mean sidereal

**HALLEY'S COMET LOCATOR**

(IBM only)

With HALLEY'S COMET LOCATOR you will be able to find this famous comet quickly and easily. You simply type in your approximate latitude and the date on which you wish to view the comet. The program will display a star map (which can be printed out) showing exactly where the comet will be, the direction you should face, and how far up in the sky you must look to see it. Also provided are helpful hints on observing and information on how the comet should appear on the dates you select. A complete manual tells how to install, run, and use the program. It also contains a special section on how best to view the comet – how to find a good location to observe from, what kind of optical aid is best, and general information on finding your way around the night sky.

Hardware requirements: IBM PC or compatible system, one or more floppy disk drives, color graphics display adapter, and 64K of RAM. A printer is optional but desirable.

Price: \$29.95 Diskette

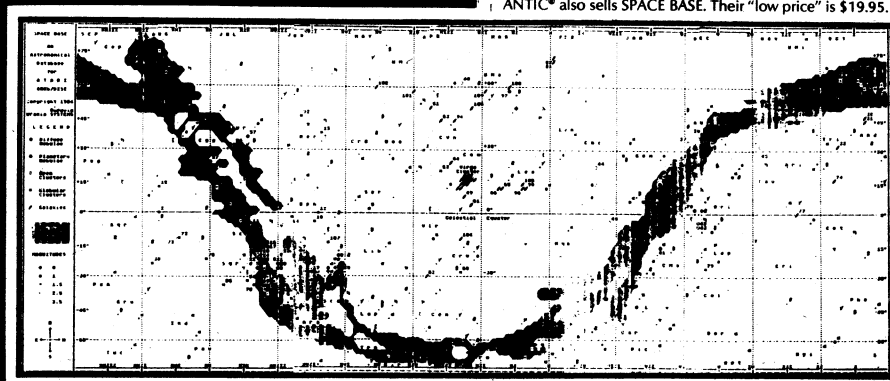

- universal (GMT)
- Greenwich mean sidereal (GMST)

All 6 are continually displayed and updated on the screen bottom. Select any one with a single keystroke to be vividly depicted in bold 2" numerals in the screen center. Assuming good accuracy in your longitude value and IBM-PC system time, all 6 standards are accurate to within 5 seconds of their true values.

Sky maps of the fixed stars and planets can also be generated for any location, time of day, and time of year. Specialized mathematical and computational techniques have been used to give this chart generator state-of-the-art speed and accuracy. A collection of 27 popular constellation patterns can be drawn on the charts for identification and orientation.

Price: \$29.95 Diskette

**SPACE BASE STAR ATLAS**

(Atari only)

SPACE BASE is an electronic realization of the traditional sky atlas and catalogue. By means of a large scrolling star mural with a cursor window, you can move your joystick to select celestial objects and gain instant access to a database containing descriptive, positional, and physical information. If you already use conventional sky atlases, you will find the ability to "pick-off" objects for detailed study will seem more like a video game than library research. The computer database is accurate and up-to-date, and you get the information fast!

Educators will find SPACE BASE informative and attractive for teaching in the classroom. It can be used in grade schools for descriptive instruction, much as you would narrate a planetarium show with a flash-light "pointer". Advanced graphics features, such as the multi-color Hertzsprung-Russell diagram, let instructors introduce the elementary concepts of astrophysics in a fascinating new manner.

If you are a new student of astronomy, you will find an enjoyable means of developing your new mental astronomical database. Using SPACE BASE, you will see the great diversity of color, temperature, and size among the brightest stars. You will also learn many of their names. As you move through the mural, you can explore many "deep-sky" objects.

SPACE BASE is easy to use – simply autoboot the disk, move about with your joystick, and select objects in the cursor window by pressing the trigger.

Price: \$17.95 Diskette

Note: ANTIC® also sells SPACE BASE. Their "low price" is \$19.95.



### TOOLWORKS™ C/80 3.1 (CP/M only)

TOOLWORKS C/80 compiler is both a professional programming tool and a great way to get started with this popular language. It supports full C structures, pointers and arrays, all storage classes, static data initialization, and in-line assembler. TOOLWORKS compiles all C arithmetic and logical operators, and all control statements, including WHILE, IF-THEN-ELSE, SWITCH-CASE, and GOTO. The only language features not supported are TYPEDEF, arguments to line macros, nested blocks, #LINE, bit fields, and double-data type. Float and long-data types are available with optional MATHPAK.

TOOLWORKS includes a source for sample utility programs, and an expanded C library of over 45 functions providing random sequential and formatted input and output, dynamic storage allocation, UNIX-style I/O redirection and command-line wild card expansion, and selectable program trace or execution time profile by subroutine.

TOOLWORKS C/80 generates 8080 assembler code for the AS absolute assembler (included), or ROMable code for Macro-80 or RMAC. Library is supplied in assembler source and REL formats plus commented C source for system dependent routines. The C/80 version 2.0 was ranked highest in execution speed and efficiency among eight 8080 C compilers in the January, 1983 Byte benchmark; C/80 3.1 is even better!

The 48-page manual includes a language summary and bibliography of C references, and complements the language reference manual, Kernighan and Ritchie's *The C Programming Language* (not included). In published reviews (see list below) TOOLWORKS C/80 consistently scores at or near the top in code efficiency, completeness of implementation, and compilation and execution time, even when compared with compilers costing many times as much. Many software products including LISP/80, MYCALC, and C/80 itself, are written in C/80. We feel it is the best value available in a CP/M C compiler, and are proud to make an excellent, affordable C implementation available to both beginners and serious software developers.

Reviewed in: *Byte* (January, 1983, benchmark, and August, 1983), *Micro Cornucopia* (August 1982), *Australian Personal Computer* (April 1983), *Dr. Dobbs' Journal* (May 1983), and *Lifelines* (May 1983).

Requires 56K. Written by Software Toolworks  
Price: \$49.95 Diskette  
\$52.45 8-inch CP/M Disk

### UVMAC (CP/M only)

UVMAC gives the assembly language programmer extra conveniences at an affordable price. Choose the Z80 version and use Zilog mnemonics, or the 8080 version which accepts source files similar to ASM. Each provides macro capabilities, plus source file inclusion so you can build libraries of subroutines, macros, or symbol definitions. You can produce absolute (COM or ABS) files directly with no need for intermediate file or load. UVMAC supports conditional assembly, selectable octal or hex listings, and listing control, and includes non-macro version, AS, more than twice as fast on long assemblies.

Requires 48K. Be sure to tell us whether you want the Z-80 or 8080 version when you order.

Written by Software Toolworks  
Price: \$29.95 Diskette  
\$32.45 8-inch CP/M Diskette

### MATHPACK C/80 (CP/M only)

MATHPACK C/80 adds true float and long data types (not subroutines) to the C/80 version 3 compiler. It includes run time library, and a program to modify your compiler for 32-bit data types. MATHPACK C/80 has efficient implementation: floating add and subtract in about 200  $\mu$ sec. at 4 MHz, floating divide in 2.2 msec., long add in 37  $\mu$ sec. Includes formatted floating point I/O and C source for transcendental function library.

Requires C/80 3.0 or later.  
Written by Software Toolworks  
Price: \$29.95 Diskette  
\$32.45 8-inch CP/M Disk

### ASSEMBLY LANGUAGE DEVELOPMENT and ANALYSIS SYSTEM (CP/M only)

ALDAS is a Z-80 assembly language development and analysis system which is compatible with CP/M versions 2.0, 2.2, 3.0, and with CP/M plus. It is both easy to use and comprehensive; a good development system for beginners as well as advanced programmers. The system includes the following software:

#### PROGRAM

- EDA.COM - Full-screen assembly language text processor and editor.
- ASE.COM - Z-80 (Zilog format) linking assembler for disk files created with EDA.
- BUG.OBJ - Full-screen machine code to assembly language program debugger.

#### UTILITIES

- EX.COM - For loading and executing machine code files created with the ASE assembler.
- CONV.COM - For converting machine code files created with the ASE assembler to CP/M loader format.
- INST.COM - Software-to-hardware configuration utility for installing ALDAS in other compatible computers.

The 80-page instruction manual clearly explains the use of the individual programs and utilities of the ALDAS system and how the programs interrelate. In addition to introducing you to the ALDAS system, the manual serves as a technical reference in case you have doubts or encounter difficulties. Although the manual contains descriptions of programming techniques made possible by ALDAS, it does not constitute a tutorial on Z-80 assembly language programming. There are many books which do that.

Software and hardware requirements:  
CP/M versions 2.0, 2.2, 3.0, or CP/M plus.  
Z-80 CPU, 48K RAM, two drives.  
24 or 25 x 80 video display with cursor controls to HOME and ADVANCE the cursor.

Price: \$49.95 Diskette  
\$52.45 8-inch CP/M Disk

### ERAS ASSEMBLER (TRS-80 only)

The ERAS ASSEMBLER is very much like ALDAS (described elsewhere). However, it includes a disassembler. Versions are available for TRS DOS 2.3, 6.0, and Model III DOS. Also available for LDOS 5.13 (Model I and III). Be sure to specify which you want when you order.

Price: \$49.95 Diskette

### EBASIC WITH STARBASE 3.2 (CP/M only)

What is EBASIC? EBASIC is a BASIC programming language which has most of the standard features of Microsoft BASIC, as well as some other capabilities which many will find interesting. In fact, EBASIC is very similar to CBASIC (available from Software Systems), except EBASIC costs only a fraction of the price. The operational differences are that EBASIC has no PEEK/POKE, PRINT USING or CALL facilities. It *does* have

FOR	NEXT	RESTORE	GOTO	LET
CLOSE	GOSUB	INPUT	ON	PRINT
READ	FILE	RETURN	OUT	END
STOP	DATA	DEF	DIM	RANDOMIZE
IF	REM	ELSE	THEN	

ABS	ASC	ATN	CHR\$	COS
COSH	FRE	INP	INT	LEFT\$
LEN	LOG	MID\$	POS	RIGHT\$
RND	SGN	SIN	SINH	STR\$
SQR	TAB	TAN	VAL	EXP

The advantages which EBASIC has over Microsoft BASIC are:

- 1) Line numbers are not necessary except for GOTO/GOSUB transfers.
- 2) "Procedures" can be included in the program at the "compile" stage (good for structured programming).
- 3) The precision is automatically 14 digits.
- 4) The syntax of the *entire* program is checked during the compile step.
- 5) EBASIC run-time programs tend to be much smaller in memory usage.
- 6) EBASIC is *much less expensive*.

EBASIC is easy to operate. We sometimes use it at DYNACOMP instead of Microsoft BASIC. A condensed manual is supplied with the diskette/disk. Also, a copy of STARBASE 3.2 (a very popular DYNACOMP program) is included on the diskette/disk so that you may examine proper EBASIC syntax. In addition, we recommend you obtain the CBASIC manual published by Osborne/McGraw-Hill (available through your local computer store). Runs on 8080 and Z80 CP/M systems. Requires 24K. A knowledge of the use of CP/M's ED.COM text editor (or some other) is assumed.

Price: \$39.95 Diskette  
\$42.45 Disk

### TOOLWORKS™ LISP/80 (CP/M and IBM only)

Experiment with the artificial intelligence language to which *Byte* magazine devoted its August, 1979, issue. Based on the INTERLISP dialect, TOOLWORKS LISP/80 offers over 75 built-in functions including large machine features like trace, file I/O, and string operations. It comes with a simple editor, file librarian, and formatted expression print routine, all written in LISP, and a 36-page manual. Also included are two artificial intelligence demonstration programs: a guessing game which learns as it plays, and a simple version of the famous ELIZA

### C/NIX (CP/M only)

C/NIX is a package which adds UNIX-like features to your CP/M system. The main features are:

- Hierarchical Directories
- Input/Output Redirection and Pipes
- Selectable Paging of Terminal Output
- UNIX-like Command Files
- On-line Documentation
- UNIX-like Commands and Utilities
- Search Path (avoids multiple copies of commands and files)

C/NIX runs in conjunction with your existing 8-bit CP/M 2.X system, and maintains complete compatibility with existing hardware, programs, and data.

The C/NIX system includes a UNIX-like shell, a small BDOS interface module, and a set of utility programs.

C/NIX is designed for computer systems with substantial disk capacity. It is useful on high-capacity floppy disk systems, but is at its best on hard disk systems. It requires at least 42K of disk space for the minimum system. The set (cmnd) and grep (cmnd) utilities require another 14K. If the on-line help feature is to be installed, about another 114K is required on the system disk or another disk.

When running, C/NIX occupies only 2.3 bytes of RAM, reducing the space available to user programs (or TPA) by that amount.

C/NIX was written in C, using the C/80 compiler from The Software Toolworks. It includes a 58-page manual.

Price: \$59.95 Diskette(s)  
\$59.95 8-inch CP/M Disk

### TOOLWORKS C COMPILER (IBM and H/Z-100 only)

The TOOLWORKS C COMPILER includes virtually a complete subset of the C programming language. It contains structures, pointers and arrays, all storage classes, and data initialization. It supports char and 16-bit int and unsigned data types; true floats and long data types are available with the optional C MATHPAK.

The TOOLWORKS C COMPILER compiles all C operators and control statements. It features a complete standard C library, with the sources for the run-time and library functions. The library functions include random/sequential file I/O, dynamic storage allocation, character/string manipulation, and low-level MS-DOS and hardware access. Generates LINK-compatible .OBJ files directly and command line I/O redirection.

Requires 128K, MS-DOS (or Z-DOS for Z-100) and one drive.

Price: \$49.95 Diskette

C MATHPAK is available for \$29.95.

psychiatrist program.

Reviewed in *Microsystems* (December, 1983).

Requires 48K. Written by Software Toolworks

Price: \$39.95 Diskette  
\$42.45 8-inch CP/M Disk



**XPL, A NON-TRADITIONAL ASSEMBLY LANGUAGE**

(8080 CP/M and IBM only)

What is XPL? It is a combination of programming language concepts. It is an assembly language that looks and feels like a high-level language. But, like other assembly languages, it lets the programmer get at the deepest levels of the machine. Traditionally, assembly language programs have been difficult to write, read, and support. They are generally cryptic. However, XPL provides the same kind of block structure as high-level languages.

XPL is an excellent systems-programming language for any job involving data structures, byte manipulation, or tasks that require little computation, but lots of logic.

XPL is easier to remember, easier to write, easier to read, and easier to maintain than "standard" assemblers.

For example, compare some XPL statements to their traditional equivalents:

XPL	8080	8088
A=L	MOV AL, L	MOV AL, BL
A=\$HL	MOV A, M	MOV AL, [BX]
A=5	LDI 5	MOV AL, 5
A=\$WORD	LDA WORD	MOV AL, [WORD]
A=A-1	DCR A	DEC AL
A=A+5	ADI 5	ADD AL, 5
A=~A	CMA	NOT AL
AF=0	XRA A	XOR AL, AL

There is also a special syntax for block-structured code. Examples are DO...LOOP, IF...ELSE, NEXT, EXIT, AGAIN, WHILE, UNTIL, GOTO, CALL, RETURN, and CASE. Data declarations can be local or global.

Program libraries are also supported.

XPL consists of a 65-page manual and a disk containing four programs to assemble, link, cross reference, and print. These programs come in two versions. One version runs on CP/M, the other runs on PC-DOS/MS-DOS. Both versions are produced from identical XPL source code. XPL implements the complete 8-bit instruction set and a compatible subset of 16-bit instructions. Using both versions together creates a cross-assembler (PC-DOS/MS-DOS to CP/M or vice versa).

The bottom line is that XPL is an easy-to-use assembly language which creates fast code and is compatible with both 8080/Z80 CP/M and PC-DOS/MS-DOS 8088 systems.

Price: \$59.95 Diskette  
\$62.45 8-inch CP/M Disk

**CAT'S TAIL GRAPHICS**

(Apple only)

Here is another nice package from the author of CAT-GRAPHIX. The programs are all in fast machine language, and you may use either the keyboard or a joystick to move the cursor (or paint brush) around. All graphics are in HI-RES, and you may include text (five fonts). Features include:

- Up to 8 X magnification for fine detail
- Color fill
- Paintbrush which lays out symbols, texture
- Box, circle, straight, and curved line generators
- Kaleidoscope mode (four-fold symmetry)
- Upper/lower case compatible
- Variable character size and spacing

Sorry, but the price on this one is too low for it to be included in or towards DYNACOMP's 10%-20% quantity discounts.

Price: \$12.95 Diskette

**MICRO™ ON THE APPLE**

(Apple only)

DYNACOMP has been fortunate to come upon a limited supply (about 5,000 volumes at the time of writing this advertisement) of Volume 2 and Volume 3 of MICRO™ ON THE APPLE (Volume 1 has sold out). Each volume consists of a 200-plus page book, spiral bound, which includes a disk of matching software. The discussions and software in these books and diskettes are aimed at the intermediate to advanced Apple II/IIplus owner. Each contains a tremendous amount of useful information; a must for the library of a serious Apple computerist.

Here is a sampling of the material covered:

**Volume 2**

- Step and Trace
- Bi-directional Scrolling
- PRINT USING for Applesoft
- Applesoft and Matrices
- AMPER-SORT
- Hi-Res Function Plotter
- Hi-Res Picture Compression
- Applayer Music Interpreter
- Galacti-Cube
- Applesoft Floating Point Routines
- How to use "Hooks"

**Volume 3**

- Amper-Search
- Cross Referencing
- Serial Line Editor
- 3-D Images
- Apple Byte Table
- How Microsoft Basic Works
- Solar System Simulation
- Othello
- Musical Duets

Requirements: Apple II/II plus, 48K of RAM.

Price: \$24.95 per Volume

The price includes the text and the diskette for one (either) volume. Both volumes may be purchased for a combination price of \$39.95. Sorry, combinations can not be used in or towards DYNACOMP's 10%-20% quantity discounts.

**GRAPHICS CREATOR**

(Commodore 64 only)

GRAPHICS CREATOR allows you (even if you know very little about programming) to create graphics displays very quickly and easily. The advanced programmer will also like this package since it allows saving screens for use in programs. GRAPHICS CREATOR generates complete programs which can be saved on disk, as well as sequential files for future editing. GRAPHICS CREATOR includes a sprite editor which allows you to generate sprite data. The sprite data can be stored on disk and later edited. Sprite data can be sent to the printer or to the monitor screen.

The GRAPHICS CREATOR menu allows you nine options:

1. Edit a new screen
2. Edit a screen from disk
3. Edit a sprite
4. Edit a sprite (multicolor)
5. Edit a sprite from disk
6. Save screen
7. Save sprite data
8. See sprite data
9. Generate a BASIC program

Requires a joystick. Printer is optional.

Price: \$29.95 Diskette

**EDI-MATE GRAPHICS ANIMATOR**

(Apple Pascal only)

EDI-MATE is a full-color high resolution graphics editor. With EDI-MATE, entire screen images may be saved to or retrieved from disk, or individual images may be saved to or retrieved from a memory buffer. Up to 143 images of any size, from one bit up (limited only by memory capacity: 2.5K to 4.5K), may be saved to the memory buffer. These stored images, in combination, allow you to form more complex images. You may work on the entire Hi-Res screen or, for more detailed work, any portion of the screen may be expanded three times. You can flip any picture horizontally or vertically and use any image as a pattern to fill an enclosed area — or as a brush for "painting" screen areas.

Images may be combined into animation sequences by the mini-animator. This animator allows creation of up to 114 sequences with a sequence consisting of any combination of individual picture placements and previously defined sequences. Sequences may also be looped for a specified number of times or until a key or button is pressed. Entire buffers of images and animation sequences may be saved to disk for later use.

Also included is a library of assembly-language procedures that may be used in Pascal programs to display images. Two sample programs are provided with heavily commented source code as examples of how to load and use picture files that have been made by EDI-MATE.

**Other Features:**

- Easy to use. All commands are available as menu choices.
- Supports a variety of input devices including joystick, paddles, and the Koala Pad®. Commands may also be input via the Apple keyboard.
- Compatible with Apple Pascal and TURTLE-GRAPHICS.
- Library of fast assembly language procedures may be used alone or with TURTLEGRAPHICS.
- Includes CHASE, a custom character set editor (available separately for \$15.00).
- Comes with a 65-page manual which carefully describes all functions.

Requires Apple Pascal 1.1 or 1.2, at least 64K of RAM, and one disk drive. Optionally, a joystick, paddles, or any other input device that plugs into the Apple "game I/O" socket may be used. A printer is supported, but not necessary.

Price: \$39.95 Diskette

**MULTI-CHAR**

(Atari only)

MULTI-CHAR is a character-set editor which makes creating and modifying Atari characters a snap. Six characters may be modified on the screen at once. Each character is represented on a 24 x 16 grid. Using the joystick, you can move about this grid editing at will. Typical uses include foreign-language alphabet creation (e.g., Hebrew, Japanese) and icon creation (e.g., space ships) for games.

MULTI-CHAR works very much like a text editor. You may load, save, and modify character sets in a very fluid manner. Characters can be individually copied from one set to another, flipped, inverted, twisted, etc.

Included are the following sample sets: crunched, fat-tened, fancy (3), Greek, italics, artfacing, and script.

Requires 32K, one drive, and one joystick.

Price: \$19.95 Diskette

**THE ART GALLERY**

(IBM only)

THE ART GALLERY is a graphics package designed to provide endless hours of creative entertainment for inspired artists and keyboard doodlers of all ages. You may browse through the gallery and draw, "sell", or rearrange pictures within the gallery.

The DRAW option includes a wide range of graphics capabilities to construct drawings: pre-drawn symbols which can be modified, free-form lines, circles, arcs, arc rotation, ovals, painting areas of the screen with solid color, color palette changes, and picture merging. Pictures can be saved in the gallery and recalled for later modification.

The BROWSE option shows a floor plan of the gallery, with a stick-person that can be "walked" around. When the stick-person approaches a picture on one of the walls, the work of art can be called up on the screen. Pictures can be printed on a graphics printer with the PrtSc (print screen) key.

The capacity of a gallery is 32 pictures. Picture file handling is managed entirely by the computer so that an understanding of disk files is not necessary.

THE ART GALLERY is exceptionally easy to operate. It is entirely menu-driven, and prompts are provided throughout the drawing process. There are no program function keys or commands to learn. This simplicity makes THE ART GALLERY especially suitable for youngsters, as well as enjoyable entertainment for adults.

THE ART GALLERY requires a graphics card and monitor, one double-density (360K) disk drive, 128K of RAM and DOS 2.0 (or later). A graphics printer is supported but optional.

Price: \$29.95 Diskette

**COMPUTER CANVAS**

(IBM only)

COMPUTER CANVAS is an easy-to-use, full function, graphics screen builder which is designed to turn your computer's screen into an artist's "canvas".

COMPUTER CANVAS uses the medium-resolution graphics mode. You can select up to 16 background colors and 3 different foreground colors on 2 separate palettes to produce pictures that may be saved on disk. There are no complicated commands to learn or special devices needed. Anybody can start using COMPUTER CANVAS within minutes.

The function keys help you to easily create circles, boxes, diagonal and straight lines, paint in entire areas in colors, alter background, foreground, and palette colors, create detailed patterns, and draw freehand on the screen using directional keys.

You can repeatedly update and add to existing pictures in addition to starting from a blank "canvas". Also, the pictures are stored on disk in a standard format, which allows them to be used by other computer programs. This makes COMPUTER CANVAS a valuable tool for those who want to add full color pictures to their programs and need an easy, quick way to create these pictures. You can also combine standard text with your full color pictures, create pictures and label them, or design charts and graphs and add titles, headings, and explanations.

All pictures created with COMPUTER CANVAS can be printed with DOS's Graphics command. The printed images are detailed reproductions produced in multiple shading to highlight the variety of colors on screen.

Requires 128K of RAM, color graphics card, and one disk drive.

**VIDEO TITLER**  
(Atari only)

The VIDEO TITLER may be used to create a wide variety of screen displays and sounds. These displays can incorporate various sized text and multicolored high resolution graphics screens. The display sequences can be used as a title generator for home video movies or as a message display board to sell or demonstrate a product. Individual displays can be photographed for use in slide presentations. The display sequences can be made to repeat making them useful for teaching or entertaining young children.

Commands are provided to make it easy and fun to paint your own high resolution graphics screens. These screens can be saved, changed and incorporated into display sequences. Detailed step by step instructions and many ready to run examples included on the program diskette make VIDEO TITLER easy to use.

Price: \$29.95 Diskette

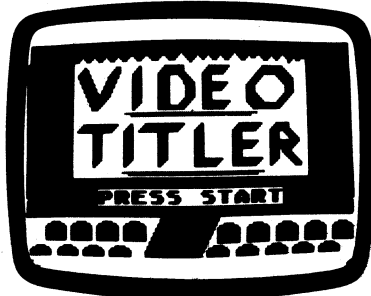

**CREATOR AND CREATOR II**  
(Osborne only)

CREATOR and CREATOR II both allow the creation of Osborne graphic displays - the display being the visible 52 X 24-character screen of the Osborne. With these programs you can draw graphic characters, pictures, and diagrams on the screen and then save the graphic displays to disk. Once saved, they can be recalled from disk and, if you have an Epson MX80 printer (expanded with the Graf-Trax option), they can even be printed.

Drawing on the screen with CREATOR and CREATOR II is much like editing a screen-sized document with Word-Star.

CREATOR is the predecessor of CREATOR II, and is less powerful than the latter. However, DYNACOMP includes it in this package so you can get some idea of how these programs work and so you may gain an understanding of some aspects of the Osborne graphic character set. CREATOR is written in MBASIC and you can examine the listing if you like. If you know how to program in BASIC you may even modify parts of the program. CREATOR II is in machine language, which allows it to run much faster than CREATOR.

CREATOR and CREATOR II can be used for diagrams, pictures, floor plans, artistic creations and the like. They are simple enough to be used by children. CREATOR is especially good in this regard.

Price: \$19.95 Diskette

**CRYSTALS**  
(Atari only)

CRYSTALS is a unique program. It is not a game or simulation, business, or technical program. It simply generates very beautiful color patterns on your screen. These fascinating graphics displays are always different and the effect is mesmerizing, much like sitting in front of an electronic fireplace! CRYSTALS has been used in retail stores to demonstrate the graphics, sound, and color capabilities of the Atari.

Requires 16K.

Price: \$14.95 Cassette  
\$18.95 Diskette

Sample display:

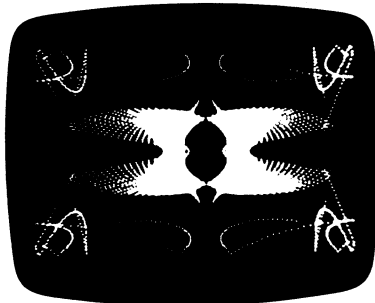

**CAT-GRAPHIX**  
(Apple only)

DYNACOMP is always on the lookout for high quality software produced by outside authors. Usually we avoid considering public-domain software because, quite frankly, it is either poorly written, trivial, or *very* specific to one person's needs. However, we occasionally encounter a piece of public-domain software which we think is good and should be more readily available to the public. What do we get from distributing this material? Certainly not much in profit (we only cover costs). However, maybe you will keep us in mind when thinking about buying quality software at good prices.

CAT-GRAPHIX is a collection of programs and sub-routines for generating low- and high-resolution graphics on the Apple. The subroutines are fast since they are written in machine language. The support programs for generating the tables and images are in Applesoft, with calls to the machine-language programs. Included are routines for rotating and scaling images, as well as for scrolling.

This is an experimenter's and programmer's package. Although there is accompanying documentation, you really have to look at how things are done by examining the demonstration programs (there are 20 of them!)

To make it easier for you to use this package, DYNACOMP provides 35 pages of instructions and programs. However, be forewarned that you will have to *read, experiment, and think!*

Price: \$12.95 Diskette  
(Note: Can not be used towards quantity discounts.)

**MAPIT**  
(IBM and CP/M-86 only)

MAPIT is a program for the creation of maps. The intent is to make mapping available to anyone with a micro-computer. A great amount of work has gone into making the program easy to learn and powerful to use. Many people will consider using this program fun, but it is meant for serious pursuits.

The uses of MAPIT are many. Some examples are population density by area, relative concentration of minerals, pictorial representation of a city block, and anything else a good imagination can supply. For a business, a typical use would be to map sales by Zip code area. More examples are power usage by city division, housing quality, number of McDonalds by state, and so on.

The medium for MAPIT is the printer. In particular, it is desirable to have a printer which has a condensed mode of about 17 characters per inch across and 12 lines per inch down. Most of the inexpensive dot-matrix printers have this capability and many letter-quality printers do too.

The use of a printer for output means the resolution is low. This fact is offset by the easy availability of equipment and various techniques of display of the maps.

MAPIT gives you the maximum amount of map for the minimum amount of work. Maps can be done over and over with very little effort. You can get your pictures "just right" without spending days on them.

Included with MAPIT are outline map files of the United States, Canada, Europe, Asia, Africa, South America, and Australia. Besides these base maps you can easily enter your own maps. Once created, the outline maps can be used again and again with different sets of data. So you can map shoes this week and mineral deposits the next—just by changing the data set.

Requires 128K and one disk drive.

Not only will MAPIT work with almost any printer, but it also works with the HP 7400 series plotters.

Also available: 48-state county outline database.

Price: \$89.95 Diskette

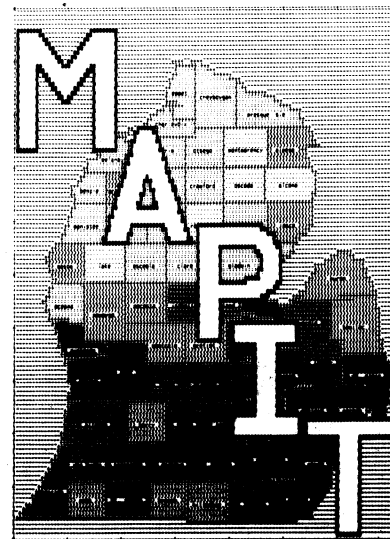

**SCREEN SCULPTOR**  
(IBM and compatibles only)

SCREEN SCULPTOR is a tool that allows you to design and create customized input screen programs in minutes, instead of hours. It is for anyone who is writing a program in IBM BASIC, IBM PASCAL, or Turbo PASCAL (all three capabilities are included in one package). The source code that is generated can be modified or merged with other programs.

SCREEN SCULPTOR is easy to use. First, it allows you to design and create input screens by "drawing" them directly on the screen. Then, it generates an actual program based on the screen design.

Facilities include: easy color selection screen, special character selection screen (to draw frames and boxes), repeat-last-character in any direction, color painting, move sections of text, and more.

The program code performs sophisticated data entry functions such as using the cursor to move from field to field, editing within a field (insert, delete, backspace, arrows, etc.), character edit checking, range checking, special field type definitions, error message displays, and much more. Simply mark off the places where input fields are to be located and, if you want, specify any special edit checking that should be performed (such as special data types: numeric only, date, yes/no, etc.).

The generated code is designed so that special modifications can be made easily by the user. Documentation shows how and where certain modifications should be made. The program code is documented.

Your benefits are:

- Saves time because SCREEN SCULPTOR generates much of the program for you.
- Programs will look better. Designer screens can be created in minutes. Program users respond better to programs that are visually pleasing.
- Data can be entered into programs more easily and more reliably. The generated program will check the data as it is being entered.

Program productivity is greatly improved because of the time saved in creating attractive and sophisticated input screens. The programs are bug-free and modifications can be reprogrammed quickly.

For the IBM PC, PC XT, PC AT, PCjr, and true compatibles. The program requires 128K of RAM, one 320K disk drive, DOS, and any 80-column display.

Price: \$119.95 Diskette

**COUNTY OUTLINE DATABASE**

The MAPIT U.S. COUNTY OUTLINE DATABASE includes county outlines for all of the United States except Alaska and Hawaii. This database can be used with MAPIT or other mapping packages. The county outlines are stored in 48 state files as ASCII text. Each county outline consists of a list of coordinate pairs measured in radians X 1,000. This allows county outlines from two or more state files to be combined. Also included is MTRANS, a program for scaling, documenting, and rotating map outlines. The DATABASE and MTRANS sell for \$95.00.

COLLECTION: MAPIT and the COUNTY OUTLINE DATABASE may be purchased as a collection for \$169.95. Sorry, collections can not be included in or towards DYNACOMP's 10%-20% quantity discounts.

**PLAYER MISSILE GRAPHICS TOOL KIT**  
(Atari only)

DYNACOMP now offers three Atari graphics development packages **PLAYER-MISSILE GRAPHICS TABLET** (P.M.G.T.; page 25 of the Winter 1982 - 1983 catalog), **PLAYER-MISSILE PLAYER EDITOR** (P.M.P.E. page 26) and **PLAYER-MISSILE TOOL KIT** (described below). The first package helps you create complicated backgrounds for your program. The second provides an easy-to-use editor for creating players and missiles, but presupposes that you already have some knowledge of how to use these players.

The third offering, **PLAYER-MISSILE TOOL KIT** is an expanded version of P.M.P.E. which **teaches** you the basics of player missile graphics and also provides very professional and easy-to-use tools for graphics development. The documentation (21 pages) is clearly and concisely written (it is excellent). It carefully explains what player-missile graphics are, and the elements of their use.

The package also includes three programs:

1. **PMINIT** - a program to be included in your own code which facilitates the operation of PM graphics. This program pokes into memory machine language software which greatly speeds up player movement.
2. **PMBUILD** - A P.M.P.E. which helps you quickly construct players and missiles for inclusion in your program.
3. **PMDEMO** - A classy demonstration program, complete with a program listing and comments, which clearly shows the use of PMINIT and how simple it is to create graphics.

To really test this package, it was given to a DYNACOMP employee who had never used player-missile graphics, and who hates games. He came back very pleased and excited about writing an animation (as he called it). He was so enthusiastic that DYNACOMP had him write this description! Requires 24K.

Price: \$25.95 Cassette  
\$29.95 Diskette

**FLIPSKETCH**  
(Atari Only)

FLIPSKETCH combines a powerful drawing program with exciting and impressive animation features. FLIPSKETCH uses low resolution graphics to allow you to create as many screens as possible. A 16K system lets you produce 8 screens, 24K allows 24 screens, 32K allows 40 screens, and 40K allows 56 screens. The screens include one background frame. Up to 24 different colors may be selected for each screen. You use a joystick to design each frame. Then you may animate (slow to rapid) your work in one of two ways: sequential animation, where each screen is displayed in the order in which it was created, or programmed animation, where you may display screens in any order you desire. With programmed animation, you can display up to 300 frames.

Your work can be saved on cassette or diskette for later retrieval. (Diskette version includes a sample animation sequence.)

Screen creation is made simple by use of the joystick and many convenient commands (line drawing; area "fill"; image moving, inversion, reflection, fading; background merging; image "subtracting", superposition; and so on). Requires 16K minimum (cassette), 24K minimum (diskette) and one joystick.

Price: \$19.95 Cassette  
\$23.95 Diskette

**ENGINEERING SKETCHPAD**  
(IBM only)

ENGINEERING SKETCHPAD is a simple graphics program for engineers, technicians, architects, interior designers, or anyone who frequently uses a straight-edge, compass, and templates to make drawings for documentation and explanation. ESP-generated drawings are quickly and easily prepared, printed, and modified. ESP is not a "paintbrush" program for general art. These are usually poorly suited to engineering drawings. Instead, it draws on a 5,000-point Cartesian coordinate system to allow the preparation of easily-read drawings (transistors, resistors, desks, etc.). These stored drawings can be rotated, mirrored, inverted, expanded, or contracted before being included in a new drawing. In addition, structures may be "dragged about" to simplify positioning them.

ESP is menu-driven to make it easily learned and retained. It comes with a concise instruction manual that also serves as a training guide with examples to help you quickly master drawing techniques.

This package was written by a working engineer to make his own job easier, and is published by DYNACOMP in the belief that useful, convenient software need not be expensive. The package includes documentation and a disk containing the compiled program, the PASCAL source code, and many electrical-engineering template drawings.

ESP requires 128K of RAM, the IBM graphics board, two disk drives, a printer, and a graphics screen dump

program to prepare hard copy of the drawings.

ESP has the option (included) of using the 8087 math co-processor for increased speed.

Price: \$29.95 Diskette

Sample screen dump:

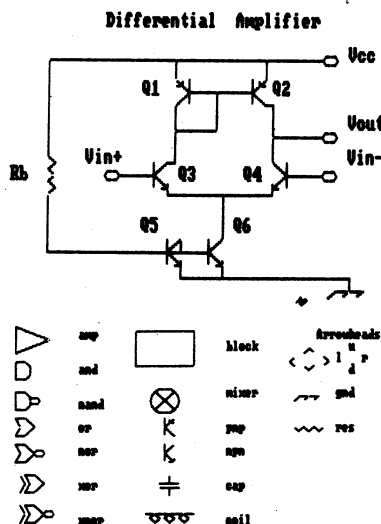

**THE SHAPE MAGICIAN**  
(Apple II, 48K Diskette)

The Apple II has several very powerful graphics features which include the ability to define shapes in a "shape table". The shapes may then be drawn, rotated and scaled on the high resolution graphics screen. This ability is useful for applications which require the repetitive drawing of similar shapes at different locations or angular orientations. Unfortunately, designing and entering shapes by hand is a tedious and error prone process, and changes are very difficult to accomplish once the table has been entered.

THE SHAPE MAGICIAN was designed to make the application of shape tables easy for even novice programmers. A 25 x 25 point grid is drawn on the screen and a graphics cursor moved on the grid to define a shape. The actual shape being defined is simultaneously displayed as it will finally look on the high resolution graphics screen. After a shape has been created, it may be stored on a diskette for later recall by an application program. Shapes may be edited and changed at any time.

THE SHAPE MAGICIAN includes complete documentation describing how to use shape tables in your own high resolution graphics applications. If you ever have wanted

to write programs using graphics, but found the programming required too tedious, then THE SHAPE MAGICIAN is the answer to your needs.

Price: \$29.95 Diskette

Sample display:

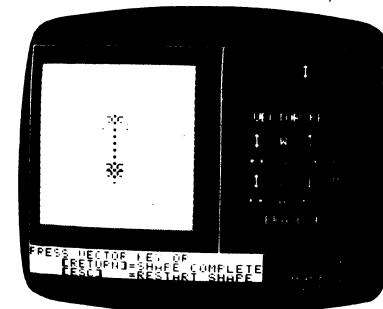

**VIDEO BILLBOARD**  
(Atari only)

VIDEO BILLBOARD is an exciting new program that makes it easy to design and display colorful text-oriented screens similar to those used on cable TV for announcements and advertisements. It can be used for advertising displays, education, and home video titling. It is an ideal attention-getter for conventions, store windows, and shopping malls. Schools can use it for class notes, timed tests, and educational TV.

Three character sizes, 128 colors, and flashing lines mean high-quality attractive displays without expensive specialized equipment.

VIDEO BILLBOARD displays can be controlled manually like a slide show, recorded on a VCR, or run unattended.

The menu-driven user interface is backed up with help screens and excellent documentation.

Up to 180 screens can be stored on a single floppy disk and a free-running display can include them all.

An Atari computer with 48K of RAM and a disk drive are required. An 80-column printer and printer interface are optional.

Price: \$59.95 Diskette

**Review of VIDEO BILLBOARD**

From ANTIC magazine, November, 1984

**Video Billboard** makes it easy for you to create fancy text display sequences in multiple colors and different sizes of letters. It's a great tool for making title screens, in-store displays, breaking new ground in video poetry, etc.

You can fill the screen with as many as ten lines of thirty characters each, or as few as four lines of fifteen characters—depending on which of the three text sizes you pick.

You choose colors for text and background of each line. For special effects, you can have any lines flashing. You can automatically display a sequence of up to 20 screens from RAM, or up to 180 screens from disk.

The documentation is very clear and full of helpful hints. In addition, fifteen screens of on-line help are available at any time. Also, you can obtain printouts of your screens. If you have a need for an easy-to-use elaborate text display, this program is for you.

**OSBOARD**  
(Osborne only)

NOTE: OSBOARD was originally distributed through Osborne Computer Corporation. It is now distributed through DYNACOMP.

OSBOARD is to graphics what a word processor is to text. OSBOARD allows you to easily create graphic screens using every possible graphic (or alphanumeric) character and video attribute built into your machine. Here are some of the review comments:

"greatly enhances the versatility and usefulness of the machine. Any Osborne user interested in exploring the computer's graphic potential should seriously consider this fine program."

George Taylor/Portable Companion

"This is the most comprehensive assembly-language graphics package evaluated by ON. (The manuals) are excellent and user readable."

Earl Holland/ON—the Osborne Newsletter

In addition to screen graphics, you may *print* your creations (see the OSGRAPH description for compatible printers). OSBOARD files may be converted (using CONVERT programs supplied) into formats which make it easy to add graphics to BASIC, CBASIC or assembly language programs. A number of sample graphics files are provided to demonstrate the powerful capabilities of this package.

Available in two versions (state which you want):

**OSBORNE 1:** Allows you to create graphics screens with widths of 52, 80 or 104 columns, even on a 52-column machine.

**EXECUTIVE:** Uses the Executive built-in "windowing" capabilities to provide block move, block fill, block delete, etc.

Price: \$29.95 Diskette  
(State version you want)

**OSBRIEF**  
(Osborne only)

NOTE: OSBRIEF was originally distributed by the Osborne Computer Corporation. It is now distributed by DYNACOMP.

Now you can create eye-popping graphic displays with ABSOLUTELY NO PROGRAMMING! That's right — NO PROGRAMMING! While most graphics editors (including our own OSBOARD) allow you to easily display files using BASIC programs, OSBRIEF allows you to sequence and display any number of graphic screens by just listing the file names in the order you wish to have them displayed — OSBRIEF does the rest! OSBRIEF is designed for use with graphic data files created with OSBOARD or with charts and graphs created with OSGRAPH.

OSBRIEF is the ideal tool for creating automated briefings, electronic slide shows, self-running demonstrations, sales aids, or for just about any use that requires attended or unattended presentation of graphic data.

A typical OSBRIEF presentation is controlled by a master file which you create with Wordstar. The master file contains the names of the graphics files to be displayed, the order in which they will be displayed, the "special effect" to be used to write each file to the screen, and the amount of time that each file will remain on-screen. Eleven spectacular special effects are available including four "wipes" (left-to-right, right-to-left, top-to-bottom, and bottom-to-top), fade-in and fade-out, curtains open and close, push up and push down, spiral, and more!

An OSBRIEF presentation must be seen to be appreciated. Each screen may be displayed from 1 to 99 seconds or it may be frozen on-screen until any key is pressed. The master file may also contain special commands to paint the screen white, black or gray as well as a command which causes the demonstration to repeat until halted.

The OSBRIEF package includes a bonus utility program called CHANGE. CHANGE converts ordinary text files (from Wordstar, SuperCalc, etc.) into a format compatible with OSBRIEF, making it easy to interweave text and graphics in your presentations.

The Osborne 1 version of OSBRIEF automatically handles files of all standard widths (i.e. 52, 80, and 104 columns). The Executive version is "upward compatible" with the Osborne 1 version; that is, it will read and display all files—even those created on an Osborne 1.

OSBRIEF is very "user friendly" and its clear and easy-to-understand manual and helpful error messages will help you to get your presentations "on the air" in a minimum of time.

Price: \$24.95 Diskette  
(Specify which model Osborne)

**COLLECTIONS**

OSBOARD, OSGRAPH and OSBRIEF may be purchased as a collection for \$69.95. Please state whether you want the single-density or double-density version. Note that collections cannot be further discounted or applied towards quantity discounts.

**Excerpts from a very positive review of:**

**DATA PLOTTER**

(by Bruce Gale, Profiles Magazine, April 1985)

"Before using Data Plotter I had purchased two other graphing programs for my Kaypro and examined sample printouts from three more. The quality of the graphs produced by Data Plotter is better than anything I had seen before. I have also been quite pleased with its 'friendliness.' For example, error messages, which are in English, are very clear (e.g., 'Label won't fit: too long or badly placed.'). Data Plotter permits you to re-key your entry and ignores all incorrect entries when it creates its plot file. The manual is 78 pages long and is well written, with good examples.

"I highly recommend this program to anyone who needs to make high-quality graphs. If you have a computer that does show graphs on the screen, you may want to run rough drafts with that program, but you'd be hard pressed to beat the hard copy output produced by Data Plotter. I frequently use Lotus 1-2-3 for data analysis onscreen, but I print the final form to a text file and use Data Plotter to produce graphs for my reports and presentations."

**OSGRAPH**  
(Osborne only)

NOTE: OSGRAPH was originally distributed through the Osborne Computer Corporation. It is now distributed through DYNACOMP.

OSGRAPH is a business graphics package which can process just about any data source (hand-entered data, SuperCalc, dBase II files, MBASIC program output, and more) into high quality horizontal or vertical bar charts, pie charts, or XY plots.

OSGRAPH is menu-driven, with chart parameters which can be changed at any time and their results displayed on the screen. Charts may be saved on disk and recalled for editing or printing. Charts are automatically labeled or custom labels may be used. Output print width is 80 columns. Works with the following printers: Epson (with Graftrax), IDS Prism 80/132 (with Dot-Plot), Microprism, C. Itoh Starwriter and Pro-writer, Okidata 82/83 (with Oki-Graph) and 92/93, NEC 8023AC, Transtar 130, Silver Reed 550, Qume Sprint 5, all Diablo 630 compatible daisy wheel printers.

Does not work on Epson MX-70.

Available for all Osborne models (state which). Compatible with the OSBOARD and OSBRIEF packages. Includes a 76-page step-by-step manual.

Price: \$34.95 Single-density version (3 diskettes)  
\$34.95 Double-density version (2 diskettes)

Sample print out:

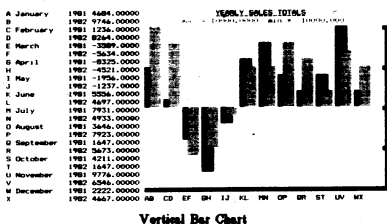

**DATA PLOTTER**  
(CP/M and IBM only)

DATA PLOTTER is not a "screen dump" program. It does not create graphs on the screen, but rather on your printer. That means you can use DATA PLOTTER with your Kaypro, Morrow, Osborne, IBM (with or without graphics), and other CP/M machines.

Here are some of the features:

- Unlimited number of labels placed anywhere on the page.
- Uneven spacing of points (either axis).
- Unlimited number of functions on one graph.
- Automatic manual scaling.
- Choice of graph size.
- Choice of numbers, words, or both as labels for X and Y axis divisions.
- 11 different symbols in six sizes for line graphs and scatterplots.
- Distinctive shadings for pie charts and bar graphs.

DATA PLOTTER plots data from an ASCII (text) file. This data can therefore be created by a word processor, dBASE II, SuperCalc, a program you have written, etc. You do not need to program to make DATA PLOTTER graphs.

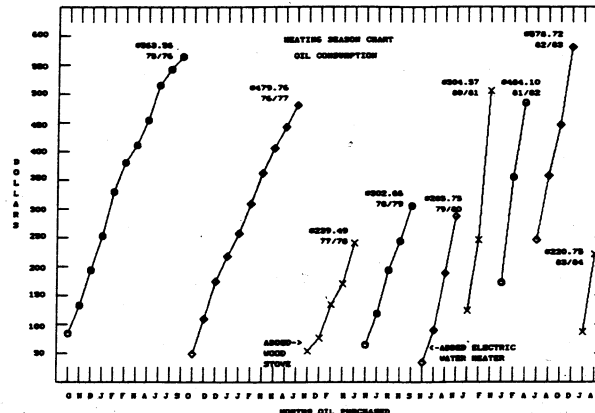

*Note:*  
Discontinuity functions.  
Many labels, placed  
anywhere on the page.

Graph from Jim Mitchell,  
Rutland, Vermont. Printed  
on Okidata 93 printer.  
Shown reduced.

**PLOT!**  
(IBM only)

PLOT! allows you to plot and process data or curves (or both) described by mathematical functions.

Most of the instructions on how to use the program are given on the screen with different options selected by the function keys. No information about minimum and maximum values, tics, or scales is required.

The processing features allow you to switch back and forth between linear, semi-log, and double-log scales, to calculate and plot the inverse, power, and linear functions of the data points. You can calculate slopes, add data stored on a diskette to the data entered from the keyboard, and find and plot the least-squares fit to the data points.

Labels can be easily placed anywhere on the graph. They can be entered from the keyboard or read from diskettes.

Any data or labels can be easily corrected without re-entering the rest of the information.

A created graph may be stored on a diskette.

All the information contained in the graph may also be printed in a concise and clear form by simply pressing a function key designated for this purpose.

DATA PLOTTER asks you a series of questions which let you design your graph with great flexibility. However, you do not have to answer these questions each time you want to make a graph. Instead, the answers can come from a previously saved file. You can use these answers repeatedly with different sets of data, or edit them to alter the graph's appearance. As you can imagine, this can be a real time saver.

DATA PLOTTER is used by many scientists, researchers, professionals, students, analysts, executives, and sales people. DATA PLOTTER graphs have also appeared in many professional journals.

The final point to note is that DATA PLOTTER is exceptionally easy to use and comes with a very clear manual.

Requirements: CP/M versions require 48K of RAM. IBM version requires 128K of RAM.

These dot-matrix printers are supported: Anadex, BDC, Centronics, C. Itoh, DEC, Epson, Pacit, GE, IBM, IDS, Mannesmann Tally, Okidata, Star Gemini, and others.

Price: \$ 99.95 Diskette  
\$102.45 8-inch CP/M Disk

Specify printer and model number.

In order to run PLOT! you need an IBM PC with a minimum of 64K of RAM, a color graphics adapter, a single- or double-sided disk drive, and PC DOS or MS DOS with BASICA.

If you have DOS 2.0 and an IBM graphics printer (or an EPSON printer with GRAPHTRAX or GRAPHTRAX-plus option) you may use the DOS GRAPHICS utility to make a hard copy of your graphs.

Price: \$29.95 Diskette

Sample display:

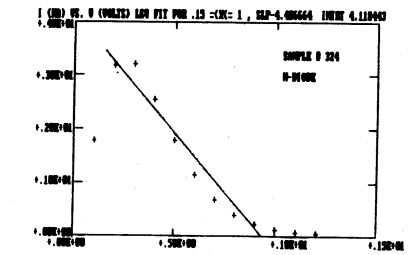

**CALCU-PLOT (by HSD)**  
(Apple only)

CALCU-PLOT provides a powerful means to transform complex equations into easy-to-read graphics. It is ideal for students, instructors, engineers, scientists, or anyone wanting a graphical or tabular display of a function.

**Features:**

- Enter your own equation or use one of 25 standard equations (you supply the parameters)
- Create or edit your own files; read Print Format VISICALC files
- Plot 250 empirical data points (Cartesian); 600 (Polar)
- Plot up to three sets of data points, or one set and one equation on the same graph
- Plot or tabulate the first and second derivatives, integrals
- Linear, semi-log, log-log, and polar coordinates
- Axis labels, titles, notes, curve identifiers
- Examples on disk, comprehensive manual
- Graphics-ready for Epson printers. Or, save graphs to disk to be later printed by a Grappler interface, GRAFPAK graphics dump, etc., (not supplied by DYNACOMP)

As you can see from the examples below, CALCU-PLOT is *powerful!*

Requires 48K of RAM and 1 or 2 disk drives.

Price: \$139.95 Diskette

**Examples:**

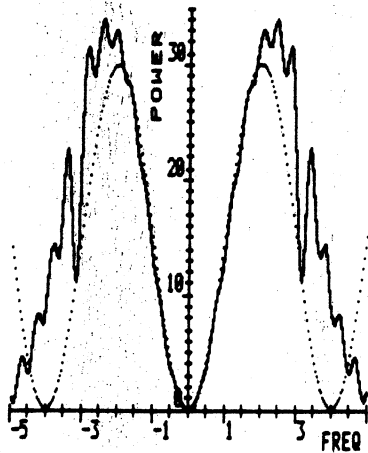

POWER SPECTRAL DENSITY & COS-FNC - PNO PSD - HFANGCOS

New equation and empirical data plot

**FOR THE BEST PRICES ON EXCELLENT QUALITY DISKETTES, SEE OUR SUPPLIES SECTION. WE DO NOT SELL THE REJECTS, SECONDS, OR REDUCED SPECIFICATION DISKETTES WHICH ARE NOW BEING SOLD AT "AMAZINGLY" LOW PRICES. THEY ARE NOT SO AMAZING IN QUALITY!**

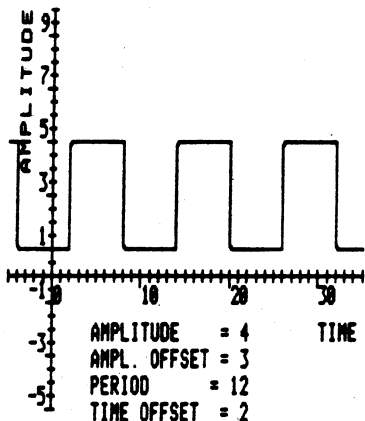

SQUARE WAVE - SQWAVE  
New equation plot

**QUICK PLOT MASTER**  
(IBM only)

QUICK PLOT MASTER enhances BASIC by providing a printer/screen alphanumeric plot command. This command allows you to easily (and quickly) include plotting in your programs by simply assigning values to an array (up to 9 dimensions; nine functions), and then invoking the plot command. Scaling is automatic, and the individual functions are numbered. By drawing lines between the numbers (see below), you can get very nice graphs from an ordinary printer.

Requires 64K and an 80-column (or wider) printer.

Price: \$19.95 Diskette

Sample Printout (with lines drawn):

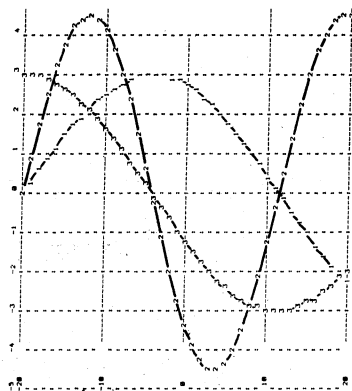

**CP/M-80 EMULATOR FOR THE IBM-PC**  
(IBM only)

Now, using ZP-EM, you can run CP/M-80 software on your IBM-PC! For example, you can use dBASE II, Micro-soft BASIC, ED, etc. All you need do is boot the ZP-EM 8080 microprocessor emulator to get the A> prompt, and the world of CP/M-80 software is available to you!

ZP-EM is a machine-language 8080 microprocessor emulator which gives your IBM-PC an effective CP/M processor speed of about one megahertz. Its only limitations are that it cannot handle code which contains Z-80 specific instructions, modifies the operating system, or accesses the hardware directly. Using the IBM display characteristics, ZP-EM will emulate Osborne, Kaypro (ADM-3), HZ-19, and DEC VT52 screens.

If you have CP/M-80 software you want to run on your IBM, here is your chance.

Requires MS-DOS 1.0 or higher and 192K of RAM.

Price: \$39.95 Diskette

Collection: Let's face it, ZP-EM is not very useful unless you can get your CP/M software onto an MS-DOS diskette. Therefore, it makes sense to offer ZP-EM and MEDIA MASTER (see DYNACOMP's price and description elsewhere) together as a package. The ZP-EM emulator and MEDIA MASTER combination is available for \$59.95. No IBM owner should be without this pair.

**MEDIA MASTER**

(Osborne, Kaypro, Z100, and IBM only)

**Note:** Just as we went to press, the IBM version of MEDIA MASTER was released. It handles 75 disk formats!

This is one of the most useful programs that you can get for your double-density Osborne! We use it every day!

The problem today's Osborne owner faces is lack of available software. Only a few companies, like DYNACOMP, continue to support the Osborne. Now, with MEDIA MASTER, you can work with diskettes written on the following machines:

- A. OSBORNE DD
- B. OSBORNE SD
- C. DEC VT 180
- D. IBM PC CP/M
- E. IBM PC DOS 1.0
- F. IBM PC DOS 2.0
- G. TI PROFESSIONAL CP/M
- H. TRS-80 I W/OMIKRON CP/M
- I. TRS-80 III W/MEMTECH CP/M
- J. TRS-80 IV CP/M+
- K. LNW-80
- L. XEROX 820 I (SD)
- M. XEROX 820 II (DD)
- N. NEC PC8001A CP/M
- O. ACTRIX
- P. CROMEMCO W/Int'l Term.
- Q. CROMEMCO CDOS (SD)
- R. CROMEMCO CDOS (DD)
- S. LOBO MAX-80
- T. MORROW MD1, MD2
- U. KAYPRO II
- V. ZENITH Z90
- W. HEATH Z-100 CP/M

- X. HEATH W/Magnolia
- Y. SYSTEL II CP/M

MEDIA MASTER is simple and very easy to use. In essence you can set each of your two drives to a *different* format. For example, you can set drive A to KAYPRO II format and Drive B to IBM MSDOS. Then you can move files between those drives at will. Here is the menu of operations you can perform:

- Copy files
- Print directory
- Display directory
- Set drive to specified format
- Erase files
- Format

MEDIA MASTER can be the key to keeping your Osborne from becoming obsolete and is a *must* for every Osborne owner.

Osborne and Kaypro Price: \$29.95 Diskette  
Z100 and IBM Price: \$36.95 Diskette

**ALPHACAT**  
(Apple only)

ALPHACAT has only one goal in life — to organize the directories on your diskette. ALPHACAT will sort and organize them alphabetically by name or type (Applesoft, integer, binary, text, etc.) or arrange according to file size. The disk directory is rewritten with the organization you've chosen. ALPHACAT does its job quickly and efficiently, and is *very* easy to use. Requires one drive and 48K of RAM.

Price: \$14.95 Diskette

**ADVANCED DISK EDITOR (ADE)**  
(Apple only)

ADE provides complete flexibility in the manipulation of disk data on a byte-by-byte level. It can be used as a learning tool, programming utility, or a general purpose repair kit for crashed disks.

All of the editing is done from a menu-screen (see below). Appearing on that screen are the location in the sector, memory location, token form, BASIC equivalent (if applicable), ASCII value, and so on. You may step through the disk byte-by-byte, forward or backward, search, replace, block move, clear a sector, enter data, mask data, toggle printer (if you have one), etc.

Recommended for the more advanced programmer. Requires 48K, one disk drive. Printer optional.

Price: \$39.95 Diskette

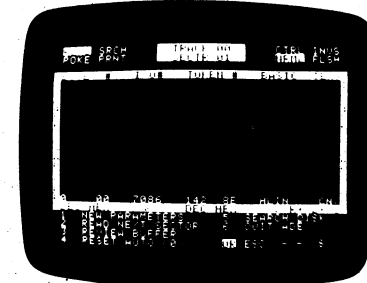



## GENERAL UTILITIES

### SMART KEYBOARD

(Atari only)

This auto-loading machine language program makes your Atari keyboard into a powerful programming tool. You can automatically execute several commands during system startup or program your keyboard to expand a single key-stroke into any set of characters desired. The single-key entry feature allows handicapped individuals to enter any character without having to press two keys simultaneously. A locked cursor feature allows cursor movement up to 50% faster without pressing the CTRL key. SMART KEYBOARD also functions as a file handler allowing your program to store characters destined for the keyboard. This very flexible tool helps intermediate to advanced programmers develop programs much more rapidly. SMART KEYBOARD is fully operable in BASIC, ASSEMBLER, and PILOT cartridge environments. Assembler source is provided for study or modification.

Price: \$19.95 Diskette

### EC DISK CATALOGER (Release 3)

(CP/M only)

EC DISK CATALOGER is the Cadillac of disk directory systems. Use it to quickly and easily catalog your disk library by just sticking disks in your drive. Briefly, here are some of the features:

- Catalogs disks smoothly one after another. No need to exit the program and press CTRL-C to reset drive for next disk. Safely recovers during cataloging if catalog disk is full. Includes all user areas. Up to 500 files per disk can be cataloged (for hard-disk users).
- Full-screen menus and displays.
- Select desired disk to display or search by "pointing" to its name on the screen, not by entering a cryptic disk number.
- Directory and other listings are alphabetical, with file sizes and space remaining on disk, and can be directed either to the screen or to the printer.
- Searches catalog for specified file name, wild-card file specification, or key word.
- Prints disk labels containing disk directory information.

Price: \$5.00 Diskette

(Does not qualify in or for quantity discounts)

## GENERAL UTILITIES

### DIVERSI-DOS

(Apple only)

Here is a disk operating system (DOS) for your Apple which has tremendous advantages over that supplied by the original manufacturer. First, DIVERSI-DOS speeds up your disk input/output by a factor of 3 or more, which is very noticeable for mail list, financial, engineering, etc. programs. Second, DIVERSI-DOS includes a keyboard buffer; you can type ahead as fast as you want. Third, with a 16K RAM card (which incidentally, DYNACOMP sells at a low price), you can buffer your printer output ("spool"). Fourth, DIVERSI-DOS can move itself to a RAM card to increase space for BASIC. And more!

Now for the surprising part. DYNACOMP's price is \$5.00 for the diskette plus \$3.00 for the documentation. When the diskette is delivered "it is then the responsibility of the customer to send a \$25 license fee" to the original publisher. Since DYNACOMP's sales are confidential, it is up to you and your conscience to send in the license fee. We think this is a very noble experiment and we will be comparing our net sales figures with the publisher's license returns (please mention that you got DIVERSI-DOS from DYNACOMP). Requires 48K, one disk drive.

Price: \$5.00 for the diskette plus \$3.00 for the documentation

NOTE: DIVERSI-DOS now contains the game DOG-FIGHT, an arcade game for the Apple.

Note: DIVERSI-DOS cannot be included in volume discounts.

- All disk directories can be printed to an ASCII file.
- On-line help screen for each catalog function.
- Date can be entered and will appear on all listings.
- Thirty page user's guide.

Requires a Z-80 based microcomputer with 64K and CP/M 2.2 or 3.0; two disk drives; 80-column x 24 line cursor-addressable terminal (or computer); 80-column printer (if listings are desired).

If you value your time and software collection, you will find this to be one of your best investments.

Price: \$29.95 Diskette  
\$32.45 8-inch Disk

### SCREEN MASTER

(Atari only)

SCREEN MASTER is a program that writes programs for you. It allows you to move a cursor about the screen to create displays or "panels", such as menus for programs or any other kind of text display. You can create panels in ATARI text graphics modes 0, 1, or 2. Simple commands allow easy repositioning of text on the screen. When the panel is done, SCREEN MASTER actually writes the BASIC statements that will reproduce the panel you have designed and stores them on disk. Later you can insert these program lines into another program you might be writing, or recall them from the disk for further editing. All the functions performed by SCREEN MASTER are selected from a menu. SCREEN MASTER makes it very easy to create visually pleasing and effective text displays.

Requires 32K.

Price: \$19.95 Diskette

## GENERAL UTILITIES

### PC CATALOG

(IBM only)

PC CATALOG is a diskette management utility that helps you keep your diskettes organized. It simplifies the task of locating a program or file, is a great aid in keeping track of where diskette space is available, and helps prevent needless duplication of a file over several diskettes.

PC CATALOG uses menu driven display screens, full-screen data entry, program function keys, forward and backward screen scrolling, and an on-screen help facility. An options file can also be set up, eliminating the need to re-enter repetitive information.

Directory information is automatically captured by reading the diskette directory and storing the information (file name, volume label, file size, creation date, and time) in a user catalog file. Optional 40-byte comments may be added to each directory entry. The catalog entries are sorted and stored in alphabetic filename sequence and may be displayed or printed. Diskette labels may also be printed.

Includes full path name support.

Requires two drives and 256K of RAM.

Price: \$29.95 Diskette

### UTIL

(Apple only)

This APPLESOFT program runs on a 48K APPLE II with access to APPLESOFT. UTIL will operate under DOS 3.2 and 3.3. UTIL will start by asking you to insert the diskette you wish to process. It will pause for you to insert the diskette you want to examine into the disk drive. UTIL will then read the diskette to determine the initial parameters it is to use (such as 3.2 vs. 3.3). The MENU page is then displayed.

The MENU shows the list of options available in UTIL, along with the currently selected slot/drive and track/sector numbers. As is the rule in UTIL, these numbers are displayed in hexadecimal. The following options are available:

SEARCH MODE	DELETE DOS
CHANGE MODE	PRINT SECTOR
CATALOG FUNCTIONS	CHANGE DISK ID
FREE SPACE	NEW TRACK SECTOR
FREE SECTORS	NEW SLOT, DRIVE
DIRECTORY SECTOR	INSTRUCTIONS/NEW
VTOC SECTOR	DISK
EDIT VTOC	DISK CLEAN-UP

Price: \$19.95 Diskette

## GENERAL UTILITIES

### CP/M and MS-DOS DATA FILE TRANSLATOR

(CP/M and IBM only)

CP/M and MS-DOS DATA FILE TRANSLATOR was designed to address a need which we have at DYNACOMP and which has been described by many who have called or written to DYNACOMP. There are many software packages in existence today (e.g., statistics, engineering, spread sheet, personal finance, etc.) which create random and/or sequential access data files. In most cases, the files generated by one package are not strictly compatible with those created by others. This has caused a great deal of inconvenience for those who want to use the same database with different software packages. To compound things, the file structure employed by these programs is generally not described in the associated manuals since the user has no need to know the details (when using just that one package). Therefore, what do you do when you want to use MULTI-LINEAR REGRESSION with your VISICALC data files?

To deal with this situation, DYNACOMP has written a software utility which permits you to unravel your data files and convert them to other formats. With CP/M and MS-DOS DATA FILE TRANSLATOR you may read multi-variable sequential files, edit those files, and write selected variables to random access files having the structure you define. You can also read from random access files, edit, and create sequential files. Sequential files may be changed in format, variables extracted from parts of sequential files edited, and written to other sequential or random files, and so on. In other words, you have complete flexibility in manipulating data files and splitting data out from random or sequential files.

In addition, if you do not know the file type or structure, CP/M and MS-DOS DATA FILE TRANSLATOR allows you to easily and conveniently probe the file to find out what type it is (random or sequential) and what its structure is.

All of the TRANSLATOR's functions are menu driven. Further, once you have determined the correct translation procedure, no matter how complex or arduous, you may save the procedure on disk so that in the future, the manipulation can be done automatically!

Another feature which has been included to help you identify data sets is a facility for plotting. All plots are done using alphanumerics, and may be sent to your printer.

Also, in our testing of the TRANSLATOR we found that people who had no prior experience in dealing with file structures quickly learned about random and sequential files and their formats, learning by experiment.

Quite frankly, we do not know why this type of utility has not been commercially available until now. The need is clear and pressing. Why didn't we write it a few years ago?

Requires at least 48K and one disk drive. A printer is supported but not necessary. Requires BASIC.

Price: \$39.95 Diskette  
\$42.45 8-inch CP/M Disk

## REMEMBER THE DISCOUNTS

3 to 4 books — 10% off

5 or More books — 20% off

Books and Software are discounted separately.

## GENERAL UTILITIES

### SUPER-64 UTILITY MENU

(Commodore 64 only)

Here is one of the most powerful and versatile utility packages available for the Commodore 64.

SUPER-64 allows you to perform many complex disk operating system (DOS) commands without having to know special internal memory locations or the confusing methods required to access these locations. With file management being so important and DOS commands so complex, SUPER-64 is a welcome relief to both new and experienced users.

SUPER-64 replaces many of those small, undocumented utilities that are scattered throughout your library. It will also relieve the frustrations of using the Commodore disk operating system.

Some of the features of the SUPER-64 UTILITY MENU are:

- Restore a deleted file.
- Write-protect a disk.
- Write-protect a file.
- Change a disk name.
- View program locations.
- Unprotect a protected disk.
- Unprotect a protected file.
- Print a disk jacket.
- Load and Run.
- Reverse scroll.
- Delete/Rename.
- Validate a disk.

These features are completely menu-driven and "user friendly". A printer is supported but not required.

Price: \$19.95 Diskette

### HINT

(Atari disk)

**ERROR 162:** You have filled up the disk (this sometimes happens with BRIDGE MASTER). Delete some old data files to make more room.

### SUPER ZAP™

(CP/M and IBM only)

Here is a disk dump and patch program that really lets you get your hands on the bits! SUPER ZAP™ provides many powerful features, yet it combines menu control with two-dimensional screen interaction for exceptional ease of use. It features a full screen display of disk records by absolute sector number, or by file and sector. It displays data in hex, octal, or ASCII. You can position the cursor with function keys and change any byte using any data format. SUPER ZAP's features include searching for sequence of data bytes in file or entire disk, dump sector contents to line printer or data file. CP/M version supports display and patch program file by memory address. SAVE FILE lets you store selected sectors for input by other programs. The CP/M version is menu-configurable for your system and terminal.

Requires 48K and cursor-addressable 80-column screen. Not available for CP/M 3.0.

MSDOS version is available for IBM PC and PCjr. only. Not available for Osborne Executive.

Price: \$24.95 Diskette  
\$27.45 8-inch CP/M Disk

Written by Software Toolworks

## GENERAL UTILITIES

### TURNKEY AND MENU

(Atari and IBM only)

#### Atari Version:

TURNKEY is a diskette-based utility program which allows you to select any BASIC program to be automatically RUN at system power-up. TURNKEY creates an AUTORUN.SYS file on your diskette. This file auto-executes the BASIC program of your choice when the console is first turned on.

MENU is a BASIC program included on the TURNKEY diskette at no extra cost. MENU lists the contents of the diskette alphabetically and allows you to RUN any BASIC program on the diskette by typing a single key. Use TURNKEY to auto-execute MENU and you have the ability to RUN any program on your diskette from the instant you turn on the Atari — a truly professional "turnkey" system!

Requires 32K Atari disk system.

Price: \$19.95 Diskette

#### IBM Version:

TURNKEY greatly simplifies the creation of batch files. These files can activate DOS commands such as DIR, run machine-language programs, or load and run BASIC programs. The batch files can be run by simply typing the name of the file while in DOS, or can be designed to execute automatically as soon as the computer is turned on. This allows you to program your disks to automatically run a BASIC or machine-language program simply by inserting the disk and turning on the computer.

TURNKEY can also create a screen setup program. This program can set the screen to colors of your choice if you have a color monitor, set screen width, set the function keys, and then either run a preselected BASIC program or display a list of programs on the disk and allow you to select a program to run.

TURNKEY requires 64K and one disk drive.

Price: \$19.95 Diskette

Programmers may distribute batch files created by TURNKEY with no royalties to DYNACOMP.

### EASY ACCESS

(IBM only)

EASY ACCESS is a communications program which allows a computer user at a remote location to call up another computer (running EASY ACCESS) and send or receive data files or programs of any type.

EASY ACCESS allows several levels of security. The manager of the host system can determine which users can send, receive, or kill files. The system manager can also determine which disk drives are available to the remote users.

With EASY ACCESS you can read from and write to all disk drives and subdirectories. EASY ACCESS keeps a log of all files sent, received, or killed, as well as the time and date of the action and the user involved. EASY ACCESS also supports the popular XMODEM file transfer protocol.

Requires a minimum of 256K of RAM, 1 disk drive, MS-DOS operating system, and a Hayes or compatible modem.

A printer is supported but not required.

Price: \$29.95 Diskette

## COMMUNICATIONS

### TEXCOM COMMUNICATIONS

(CP/M only — see below)

TEXCOM is a top-of-the-line communications package which allows your computer to communicate (via modem) with other computers (e.g., friends, networks, data bases, etc.).

#### Some of TEXCOM's features include:

- Use your computer as a simple terminal or as a complete (and sophisticated) communications facility.
- Sends and receives disk files automatically.
- Recognizes XMODEM, XON-XOFF and line prompt (the latter two with variable control characters) protocols.
- Contains a 71-command control language which is easy to learn.
- Commands may be issued from the keyboard or imbedded in files for previously programmed control.
- Help menus are on line.
- Communicate independently and make decisions based on incoming data.
- Files being sent may call for other files to be sent in a nested pattern.
- 50-page manual to provide help if you really need it.
- Comes already configured for your machine.

#### Typical uses include:

- Automatic electronic mail pickup and drop.
- Sending bibliographic search patterns.
- Computer conferencing.
- Terminal simulation.
- Down-loading and up-loading of data.
- Sending large texts consisting of many files.
- Logging in and out of complicated systems.
- Previously programmed searches of data bases and down-loading when data is found.
- Remotely running programs on other computers and down-loading the results.

#### Machines covered are:

KAYPRO II (SSDD) OSBORNE-1 (SSSD)  
 KAYPRO IV (DSDD) OSBORNE EXECUTIVE (SSDD)  
 KAYPRO 10 (DSDD) MORROW MD2 (SSDD)  
 MORROW MD3 (DSDD)

Requires a modem (of course!).

Please be sure to state which machine when you order.

Price: \$49.95 Diskette

### ULTRA TERMINAL-64

(Commodore C-64 Cartridge)

ULTRA TERMINAL-64 is a dual-purpose cartridge which can turn your C-64 into a very smart terminal. It can be used for RS232C communications (in conjunction with the VIC 1011A RS232C interface) or over the phone (with the inexpensive VIC modem).

#### The features include:

- Easy installation. Just plug it in.
- Download to disk (if you have one).
- Dump to printer (if you have one).
- Elapsed time clock.
- Selectable baud, parity, stop bits, word length, half/full duplex, etc.
- All functions menu-selected.

With ULTRA TERMINAL-64 you can communicate with *The Source*, *CompuServe*, other C-64's, etc.

Price: \$69.95 Cartridge

## COMMUNICATIONS

### PlayNET™ STARTER KIT

(Commodore 64 and 128 only)

PlayNET™ is a telecommunications and entertainment network. All you need is a C-64 or C-128, a modem, and the PlayNET™ system disk, and you are off and running. Since the network is set up with 500 local exchange "repeaters", you need only make a local call (or, at worst, within your state) to access the national system. Many other systems require long-distance (expensive) connections.

Here are some of the features:

- Talk: By typing on-line you can talk "live" to all kinds of people... all across the country—and you beat the long-distance phone rates!
- Electronic Mail: You can send private messages or letters to any other subscriber.
- Bulletin Boards: You can post announcements, or check bulletins posted by other people. There are several bulletin boards for different hobbies and interests.
- Personal File Transfer: You can exchange programs or files with other PlayNET subscribers.
- Software Library: Thousands of public-domain software programs are available for downloading to your computer.
- Software Trading Post: You can sell your own software creations for fun and profit.
- On-Line Updates: You can update your PlayNET disks on-line as new games and features are added to the PlayNET system.
- PlayNET Shopping Center: You can order software and other exciting products on line.
- Monthly Newsletter: You'll read about upcoming events, tournaments, contests, and news every month.
- Sub-Accounts: You can create up to 5 sub-accounts free, where everyone gets their own screen identity.
- Games: PlayNET lets you play exciting multi-player games across the country with anyone on the PlayNET system! All the games have full-color graphics, and they're all interactive.

Here is what *RUN* magazine (August, 1985) had to say about PlayNET: "This is a great opportunity to meet people from all across the nation and share ideas and opinions with them. Your home computer can broaden your horizons by giving you this chance to travel beyond your own hometown."

PlayNET also has surprisingly low access charges. You can either pay an \$8.00/month service charge and \$2.75 per on-line hour, or no service charge and \$3.75 per on-line hour.

So far this sounds like quite a deal, but there is even more! With the PlayNET starter kit you also get two game disks which include BACKGAMMON, CAPTURE THE FLAG, CHESS, CONTRACT BRIDGE, GO, QUAD 64™, SEA STRIKE™, BOXES, CHECKERS, CHINESE CHECKERS, HANGMAN, REVERSI, and GOMOKU. These are not one-player games; you must play against another person. This can be accomplished by placing a request on the network to find another player; a very pleasant way to meet people!

PlayNET is very easy to use. It is clear and menu-driven. Connecting up is simple, and the 66-page manual walks you through all of the steps and facilities.

The PlayNET STARTER KIT contains all of the software you will need to sign on. Note, however, that you must have a Visa or Master Charge account to use the system (that's how the billing is done).

Price: \$19.95 3-diskette Starter Kit

NOTE: The starter kit does not include any free access time.

**BUTLER ADVENTURE**

(CP/M and IBM only)

For young people (7-11)

BUTLER is an adventure-type game that is intended to be both entertaining and educational. The game requires that the player read the descriptions and keep track of where the objects and the player are. In order to move between certain places, the player must solve word scrambles or arithmetic expressions. A floor plan (map) of the mansion is provided. The map helps younger players to see their progress and helps to maintain their interest and attention. More advanced players can begin playing with or without the map. Mapping the game as they play provides an extra challenge for older children. The game remains challenging even with the map and many adults find the game challenging. The game, however, is not extremely difficult and will not prove impossible to solve for any child from seven to eleven years old.

The game has three levels of difficulty: low, medium, and high. At the low-difficulty level the arithmetic expressions are limited to simple addition problems and the word scrambles are restricted to words of three or fewer letters. The medium-difficulty level uses arithmetic expressions that include addition, subtraction, multiplication, and division of integers between 0 and 9. Medium-level scrambles are limited to words of six or fewer letters. The highest level of difficulty allows integers between 0 and 99 and words of up to nine letters. The difficulty levels are associated with the moves that require solution of problems only. The balance of the game is the same regardless of the difficulty level chosen.

The game is won if the player succeeds in getting 225 points in 190 or fewer moves. Points are awarded for successfully storing in the vault the 13 items that are listed at the beginning of the game. Points are also won for finding certain "hidden" rooms, for putting everything in the vault, and for exploring all of the rooms in fewer than 190 moves.

The program responds to about 20 verbs such as GO, LOOK, TAKE, and PUT, and about 40 nouns, including 12 directions such as NORTH, EAST, UP, DOWN, BACK, SOUTHWEST, and IN. The game encourages players to try a variety of one- and two-word commands in order to test the limits of the game.

Requires 48K.

Price: \$19.95 Diskette  
\$22.45 8-inch CP/M Disk



NOTE: IBM version requires color graphics board.

**ESPIONAGE**

(Atari only)

ESPIONAGE is an action game in which you play the role of a secret agent sneaking into a criminal's hideout. You must capture the secret plans which could affect the future of the entire world. Using your joystick you jump over and duck under various hazards, searching for hidden clues with which to find and open the safe where the plans are kept. When you get to the safe, don't relax; you still have to open it and get out of the building. Play with 15 different variations. Requires one joystick and 32K in the cassette version, 48K in the diskette version.

Price: \$12.95 Cassette  
\$16.95 Diskette

**EAMON ADVENTURES**

(Apple 48K disk only)

The EAMON Dungeons and Dragons™ series is a collection of public-domain programs written using the EAMON designer and utilities disks (also available through DYNACOMP). Each adventure is a fantasy role-playing game. With your help the computer generates your character and plays him (or her). To play any of the adventures you need the EAMON MASTER, which includes BEGINNERS CAVE. To design your own adventures, you will need EAMON DESIGNER, which includes instructions (on the disk). Also very useful are the utility disks. DYNACOMP's prices for these programs simply reflect our operating costs:

Price: \$5.00 per Diskette (1-4)  
\$4.00 per Diskette (5-9)  
\$3.75 per Diskette (10-4)

Price for the entire collection is \$150

The prices for these diskettes are too low to permit inclusion of this series in our usual 10%-20% quantity discount. Sorry!

The collection:

- |                                 |                                  |
|---------------------------------|----------------------------------|
| A. EAMON Designer               | 24. Black Mountain               |
| B. EAMON Utility #1             | 25. Nuclear Nightmare            |
| C. EAMON Utility #2             | 26. Assault on the Mole Man      |
| D. EAMON Utility #3             | 27. Revenge of the Mole Man      |
| 1. EAMON Master/Beginner's Cave | 28. Tower of London              |
| 2. Lair of the Minotaur         | 29. Lost Island of Apple         |
| 3. Cave of the Mind             | 30. Underground City             |
| 4. Zypur River Venture          | 31. Gauntlet                     |
| 5. Castle of Doom               | 32. House of Ill Repute          |
| 6. Death Star                   | 33. Orb of Polaris               |
| 7. Devil's Tomb                 | 34. Death's Gateway              |
| 8. Abductor's Quarters          | 35. Lair of Mutants              |
| 9. Assault on the Clone Master  | 36. Citadel of Blood             |
| 10. Magic Kingdom               | 37. Quest for the Holy Grail     |
| 11. Tomb of Molinar             | 38. City in the Clouds           |
| 12. Quest of Trezore            | 39. Museum of Un-natural History |
| 13. Caves of Treasure Island    | 40. Daemon's Playground          |
| 14. Furioso                     | 41. Caverns of Lanst             |
| 15. Heroe's Castle              | 42. Alternate Beginner's Cave    |
| 16. Caves of Mondamen           | 43. Ground Zero                  |
| 17. Merlin's Castle             | 44. The EAMON Railroad           |
| 18. Hogarth Castle              | 45. Top Secret                   |
| 19. Death Trap                  | 46. The Lost World               |
| 20. Black Death                 | 47. The Strange Resort           |
| 21. Quest for Marron            |                                  |
| 22. Senator's Chambers          |                                  |
| 23. Temple of Ngurt             |                                  |

Note: Numbers 1-4, 6-9, 12, 15, 17, 19, 24, and 32 have a game-save feature. Number 32 contains obscenity and is not recommended.

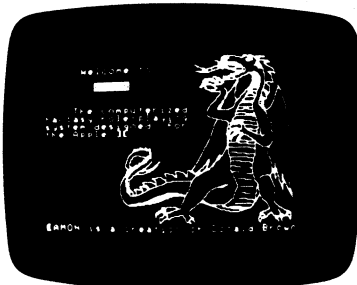
**THE CP/M GAME DISK**

(CP/M only)

DYNACOMP has long been the major source of diversified software for the CP/M environment. In particular, DYNACOMP is one of the few companies which supplies games for general CP/M machines.

Usually our games require Microsoft BASIC to operate. This group is an exception. The three games contained on THE CP/M GAME DISK are written in machine language and will run under any CP/M system having an 8080/280 compatible microprocessor (e.g., Xerox 820, Altos, North Star, Osborne, etc.). In addition, these programs utilize the cursor controls of your video terminal. This is accomplished by running an "installation" program which allows you to choose a particular terminal, or define your terminal characteristics. Cursor control is required because two of the games are arcade in nature.

THE CP/M GAME DISK contains three different programs:

1. **THE GAME ADVENTURE:** This is a very large adventure program which has several features. For example, you not only open doors, pick up and drop things, etc., but you also meet people and have conversations. Also, part of the game is to figure out what the goal is, based on clues you are given (messages, comments from people you speak to, etc.). This is quite an involved game, and will take many sessions to solve (you may save your current game and continue it later).

Age range: 12 and up

2. **ALLEY CAT:** This is an arcade game which uses alphanumeric characters to create a PACMAN™-like animation. The effect is surprisingly good. Your cat is roaming the streets trying to find fish in garbage cans. However, there are fast taxicabs also cruising those streets. Your goal is to go *chomp* and not *splat*.

For players ages 10 and up.

3. **BOWLING:** This is another arcade-like game. It is fairly simple. You have to position your ball and then deliver it. It will then roll down the alley and hit pins. The computer keeps score.

Age range: 8 to 13

Requires a Z80 microprocessor, at least 54K, a video terminal (display), and one disk drive.

Price: \$19.95 Diskette  
\$22.45 8-inch CP/M Disk

**UNCLE HARRY'S WILL**

(North Star, CP/M, and IBM only)

Uncle Harry has died! You are called to his house on the east coast of the country to hear the will. The will leaves everything to you! The only problem is that he failed to tell where "everything" is located. Not even a map! The only thing that might help is a poem which gives clues on where to look. You will have to travel by both car and foot from coast to coast and border to border to solve this ADVENTURE. There are over 300 locations. This game requires a 40K system. Be careful and watch out for red herrings! Good Luck! Price: \$24.95 Diskette  
\$27.45 8" CP/M Disk

**WHEMBLY CASTLE ADVENTURE**

(North Star only)

John Whembly was a knight, pirate, and RICH! He owned a large castle located on an island in a small lake somewhere in jolly old England. Before he died, he hid somewhere a chest of gold coins (or so it is claimed). Many people have tried to find it but none have succeeded. Maybe you will have better luck!

Price: \$19.95 Diskette

**LOS ANGELES ON A DISK**

(IBM only)

LOS ANGELES ON A DISK includes two disks, an instruction manual, and a map. It is a text-and-graphics adventure in which your goal is to find a hidden prize while trying to survive in L.A. In the process, you will learn your way around metropolitan LA.

Features:

- Includes over 300 real points of interest found in the greater Los Angeles area: restaurants, entertainment, sports, culture, hotels, and hospitals. Up to 100 new places can be added to the game.
- Over 20,000 words are used in the text. The graphics include a map which interacts with the game.
- Covers almost 2,000 square miles involving the 91 cities in the greater LA area.
- Trackers: Their function is to stalk and eliminate the player.

Pedestrians will help you with directions to a specific point of interest or the nearest Tracker.

Gas stations will help you fix the car, get gas, look at a map, or find out what city you are in.

Phone booths will help you locate the nearest place for food, sleep, sports, entertainment, culture, or medical care.

Help-wanted locations provide a quick way to make money.

LOS ANGELES ON A DISK is a one- or two-player game which can be played by anyone 10 years of age or older. Strategy is more important than agility. (This is one of the few computer games that an adult can play better than a child.) You can start out on level 0 for sightseeing or choose more difficult play through level 9. There are various modes of transportation in the game including walking, driving, and flying. For traveling great distances quickly, you can use one of the eight airports.

A second diskette is included which will allow you to customize the game or even create your own city. It also contains a new "sample" city and programming information.

Requires 128K of RAM, color graphics, and DOS 2.0 or higher.

Price: \$19.95 Two diskettes

Sample display:

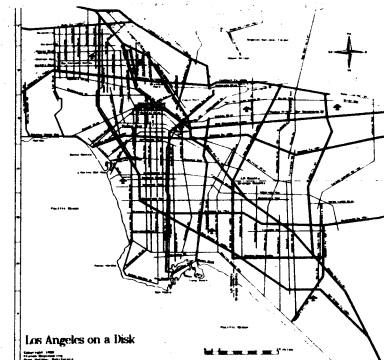

Los Angeles on a Disk

## ADVENTURE GAMES

### WINDMERE ESTATE ADVENTURE (North Star and Apple only)

The WINDMERE ESTATE ADVENTURE is an exploration simulation. You start in the Rose Garden on the grounds of Windmere Estate. Using the computer and two-word sentences, you attempt to find all the treasures and deposit them safely at the treasure drop. There are a number of puzzles to solve (e.g. how to get to the Warehouse). There are some tricky areas where caution should be exercised or you will not survive. The key to winning the game is to successfully discover and enter all the hidden rooms (which abound).

The object of the game is to score all the points. Each item considered a 'treasure' has a number of points assigned to it, and the points will be credited to your score when that item is DROPPED at the Warehouse. When the last treasure is DROPPED at the treasure store, you will arrive at the last puzzle of the game. A successful solution to that problem gives you the final victory!

The computer will recognize many one- or two-word commands including quite a few verbs and nouns. Examples: HELP, QUIT, LOOK, NORTH, N, SE, and DOWN. This is not a complete list by any means. Some two-word commands are: GO SOUTH, POUR WATER, and TAKE ROPE. In some cases, where you are determining the validity of a command (CLIMB, ATTACH ROPE, etc.) At other times a command will be valid only if you have some special item in your possession (PRY GATE). There are also cases where some previous action must have been successful before a command is valid (e.g. TAKE RATS).

On occasion you will find an item that is obviously not a 'treasure'. An example of this is a lamp. This can be carried about and used to light dark areas (use LIGHT ON, or simply ON to start it. Use OFF to turn it off to conserve power.) There are many other useful items lying around for your use. You are allowed to carry only seven items at one time — unless you can set one inside something else!

Circumstances sometimes arise, particularly with an experienced player, that will cause the player to die. There are some bats flying all over the place, and these bats are deadly! There is one sure repellent available somewhere out there. Stumbling in the dark or stepping into dark holes are other ways of doing yourself in.

Requires 48K.

Price: \$29.95 diskette

### STARSHIP LANDING PARTY ADVENTURE

(Apple, TRS-80, IBM, and Atari only)

While on patrol, your starship suddenly encountered a severe cosmic storm. The shields snapped on automatically, protecting the ship, but the tremendous energy drain as the shields fought the storm burned out all the ship's power crystals. Limping along on battery power, your starship managed to reach an abandoned solar system and attain an unstable orbit around an abandoned mining planet. The orbit is decaying and your starship will reach the atmosphere and burn up in 12 hours. There is just enough power left to beam down one person, armed only with a hand laser, and then beam that person back up again with a supply of power crystals.

Unfortunately, the planet was mined out and abandoned years ago. There is a legend, however, that one crazy old miner working an isolated mine in a valley surrounded by high cliffs made a rich strike many years ago and never sold the crystals. He died many years ago without ever telling anyone where he hid the crystals he had found. What's more, rumor has it that he was so afraid of thieves that he left a series of traps at his mining camp to keep anyone from getting the crystals.

Uses full-sentence input and features move take-back. Your job is to get those crystals! Requires 32K for TRS-80 and 48K for Atari.

Price: \$15.95 Cassette  
\$19.95 Diskette

## ADVENTURE GAMES

### GENESIS - THE ADVENTURE CREATOR (Apple only)

Until now, if you wanted to write an adventure game, you needed lots of time and considerable programming skill. Such a task requires you not only to create a world—the fun part—but to write routines to keep track of everything taking place in it—the drudgery. Now however, there is GENESIS. GENESIS removes this drudgery from creating adventures. You design your world—GENESIS programs it.

GENESIS has two parts. The Creator allows you to create and edit your adventures. The Player allows you, or anyone else, to play any adventure you have created. After you get a feel for the system, you will probably be able to create a moderate sized game of about thirty-five locations in one to two hours—a great improvement over the weeks or months it would take were you doing the programming yourself in BASIC or another language.

A 60-page "how-to-do-it" manual is included.

NOTE: GENESIS was originally published by HEXCRAFT, and is now published by DYNACOMP. See review in *Softalk*. Requires disk drive, 48K RAM.

Price: \$49.95 Diskette

### CRANSTON MANOR ADVENTURE (North Star and CP/M only)

North Star and CP/M users finally have available a most intriguing adventure program. The CRANSTON MANOR ADVENTURE takes you into mysterious (and dangerous!) Cranston Manor where you attempt to collect its many treasures. Lurking in the Manor are wild animals and robots who will not give up the treasures without a fight! This challenging program will provide you with many hours (days?) of fascination. The adventure may be interrupted at will and your status saved onto the diskette. Any number of people may play. The CRANSTON MANOR diskette will store over 200 suspended games.

CRANSTON MANOR comes with a 6 page instruction booklet which outlines the means of play, but does not give away the solution!

The Apple version of CRANSTON MANOR (not distributed by DYNACOMP) is in the top 30 of SOFTALK's popularity list!

Price: \$19.95 Diskette  
\$22.45 CP/M Disk



## ADVENTURE GAMES

### DO-IT-YOURSELF ADVENTURE KIT and DORMAC'S CASTLE (TRS-80 only)

Here is a package which should interest the computerist who wants to get involved in building computer adventures. This kit provides the data file and screen display management software required to build a modestly sized adventure program which has the following characteristics:

- 94 rooms (locations) with up to 4 doors (ties) each.
- 4 key rooms (needing special objects to get into)
- 2 disaster rooms (random deaths)
- Unlimited number of darkness rooms (needing flashlight, etc.)
- 15 help objects
- 10 treasures
- (up to) 192-character room descriptions
- creatures, traps, clues, home base, etc.
- verb/noun commands ('GET LAMP')
- "Save game in progress" feature

This kit allows quite a bit of variety in creating adventure games. The kit also includes DORMAC'S CAVE, an adventure game built using the kit.

Requires 48K.

Price: \$29.95 Diskette

### GUMBALL RALLY ADVENTURE (North Star, CP/M, and IBM only)

The GUMBALL RALLY ADVENTURE is based loosely on the movie "Gumball Rally". It is an outlaw race from the East Coast to the West Coast by any route you choose. You can go as fast as you want; but, if you crash or get thrown in jail for reckless driving, you lose! Ordinarily, you would have a map to plan your route; but, as every true adventurer knows, you must draw your own map! In the movie, the winner won a gumball dispenser of the type you used to find on the sidewalk in front of drugstores. Hence, the name.

In this adventure, your goal is to first find your way to the finish line, and second to maintain the highest possible speed on all roads. Your choice of vehicle will determine your maximum speed and your range. (Big-engined cars burn more gas!) There are gas stations along your route where you can refuel when needed. Your score depends on your average speed.

#### COMMANDS

As in most adventure programs, you "talk" to the computer in one-word or two-word commands. For example, "GET GAS" or "FIX TIRE". In addition, in this program, you control the speed of your car by typing a number representing the speed you wish to travel. Your speed around turns or on curvy roads will depend on the sharpness of the turn. The sharper the turn, the lower the maximum safe speed. On straight stretches, you can go as fast as your car will allow, but you must decelerate before entering a turn. Failure to decelerate may result in your demise!!

GUMBALL RALLY ADVENTURE will provide you with many hours of enjoyment.

Requires 32K.

Price: \$21.95 Diskette  
\$24.45 Disk



## ADVENTURE GAMES

### VALLEY OF THE KINGS (Atari diskette only; 48K)

VALLEY OF THE KINGS is an exciting and challenging graphics adventure for the Atari. The adventurers must use their skills to locate objects and passages. There are keys, matches, locked gates, swords, coins, rings, magic daggers, dark passages, guarded temples, fierce princes, gruesome trolls, mountain bandits, and strange guard beasts. And these are just the ones you will meet in your first journey!!! VALLEY OF THE KINGS is a triple journey adventure.

Your first journey places you in the mountainous region of southern Egypt. Hidden in the mountains are treasure and danger. If you survive you will gain the riches and skills needed for your second journey. In the second journey you find yourself deep in the tunnels beneath the city of Armant. Many enter these tunnels but few discover the secret of the maze and the only passage out. That passage leads to the third and final journey, perhaps your very last...

The final journey sends you against the powers of the Kings. You must outmaneuver each one to gain access to the valley and your reward.

VALLEY OF THE KINGS fills an entire diskette and has been said to be "the best Atari graphics adventure available." It is available only through DYNACOMP and its dealers.

Price: \$19.95 Diskette

### SCHRECKEN! (Atari only)

Can you remember the total involvement you experienced as a kid in a darkened movie theater watching a film that kept you on the edge of your seat? DYNACOMP's new graphic adventure, SCHRECKEN!, recaptures that excitement and includes the action control of a computer game.

SCHRECKEN! takes you into a world of ultimate evil, supernatural opponents, gods and goddesses, weapons, treasure, and an extremely fallible, yet indomitably courageous hero — you.

All the qualities of a good film are here — suspense, drama, humor, and a recognizable plot — set against the background of high-resolution graphics and a completely first-person perspective in the Stronghold of Fear.

Evil monks get larger as they approach, a monstrous dog snatches your dinner, a gigantic head awaits to swallow you — all in the world of SCHRECKEN!

Requires 48K and a joystick.

Price: \$19.95 Diskette

#### HINT

Check our supplies section for GREAT prices on name-brand diskettes!

## ADVENTURE GAMES

### THE ORIGINAL ADVENTURE

(Atari and CP/M only)

This is an updated version of the classic adventure game which first appeared on the DEC computer. It is still one of the *largest* adventures available, and is still fun to play. Because DYNACOMP has spent little time in developing this package, we can offer it to you at a *very* low price. Requires 48K.

CPM version requires 48K, 8080 or Z80 microprocessor (will not run on IBM PC without Z80 emulator).

Atari version requires 32K (cassette), 40K diskette. Sorry, cannot be used towards or in 10%-20% quantity discounts.

Price: \$ 9.95 Diskette  
\$12.45 8" CP/M Disk

### ZODIAC CASTLE ADVENTURE

(North Star and Apple only)

The ZODIAC CASTLE ADVENTURE has much the same program layout as the WINDMERE CASTLE ADVENTURE. This time you start in a glen near the castle and must find and accumulate treasures. The play is the same, but the treasures and circumstances are different.

Requires 48K. Price: \$29.95 diskette

### MIGHT & MAGIC

(Apple only)

MIGHT & MAGIC is a fantasy role-playing game for your Apple computer. Players create a personal character and journey into an adventure in hopes of becoming richer and more powerful while trying to complete their quest.

MIGHT & MAGIC adventures take place on the continent of Wingster. Wingster is a land where the forces of evil and good constantly battle for power and wealth. It is a world of powerful wizards, great warriors, and cunning thieves. Wingster is inhabited by Dwarves, Elves, Hobbits, and Man. It is also a land of countless monsters and beasts created by the "Dark Side".

There are many special features of MIGHT & MAGIC. The game allows players to create and store their characters on the MIGHT & MAGIC side of the disk. Because countless traps and monsters are encountered during the adventure, MIGHT & MAGIC incorporates a unique combat system featuring round-by-round combat. During each round the player may select the character's weapon and tactic for that round of combat. Players may also save their game at any time during the adventure. The character's data, special abilities, and equipment may be obtained at any time showing the player everything about the character. Throughout the adventure there is a two-line status display giving the location, hunger, need for sleep, power points, time, and physical condition of the character. There is also a complete rule book on the disk for easy reference.

The dungeon adventure on the back side of the MIGHT & MAGIC disk is THE LAVA PITS OF AZNAR. In this adventure the players pit their strength and wit against the awesome forces which dwell in the volcanic dungeon during their quest for the amulet of the "High Lord of Aznar".

A must for the Dungeons and Dragons™ fan.

Requires 48K and one disk drive.

Price: \$39.95 Diskette

## CARD GAMES (BRIDGE)

### BEGINNERS' ADVENTURES

(TRS-80 only)

This is a collection of mini-adventures designed for first-time adventure players. Each adventure has a specific goal, is challenging, but is not so difficult as to be frustrating. You are supplied a list of verbs and nouns used in the commands (this makes life a lot easier!), but it is up to you to work your way from there. These games are also priced low (sorry, no inclusion in quantity discounts), giving you an inexpensive introduction to adventuring.

MONASTERY OF GWYDION  
MEDUSA'S REVENGE  
KING REX III'S TOMB \$13.95 each (Diskette)  
MISSILE SUBMARINE WARFARE  
PITS OF HEMLOCK

### BRIDGE PARTNER ALICE

(CP/M and IBM only)

ALICE is an ABSOLUTELY UNIQUE bridge bidding and playing program. There's nothing like it anywhere. It has features for both beginning and advanced players. If you want to just sit down and play some good bridge, get DYNACOMP's BRIDGE MASTER or BRIDGE 5.2. However, if you want to really delve into bidding, consider ALICE.

ALICE's bidding method is very sophisticated and operates in two modes: *practice* and *learning*.

#### BIDDING PRACTICE

ALICE comes already programmed to bid Standard American Five Card Major. She was given a lesson (more about this below) in this method by a professional bridge instructor. She will respond to conventions such as the Blackwood. Her bids are based on point counts, high card location, suit distribution, and the sequence of bids. There are approximately one million hands to choose from by number, and any hand can be recalled again for either bid or play.

#### BIDDING LEARNING

When ALICE first arrives at your doorstep she knows how to bid, but should be taught more. The more you teach her, the better she will bid by your *method*. This is a true example of *artificial intelligence*.

In the learning mode, all the hands are turned up. ALICE will bid for each of the three other players. Each time she bids you can either accept her bid or you can tell her what a better bid might be. She will evaluate what you told her and store that information.

The advanced player can use this mode to really fine tune ALICE by adding conventions, including your own signals, etc. The beginning player can use this mode, together with a book on bridge, to learn with ALICE! In any case, you will get a chance to bid on many hands and *think* about bidding. (Some companies market programs which just provide hands for bidding!)

After bidding a hand, you may either play it or go on to another bid. You can play with all hands showing (that's cheating, but it is informative). You can also choose to have ALICE play all four hands. For the beginning player this is a real advantage in that you can see what the appropriate plays are and, in particular, how to finesse. Also, if the rest of the game is obvious, ALICE can automatically play it out (an honest approach to claiming).

ALICE uses standard opening leads (e.g., king from touching ace-king, fourth from the "longest and strongest," etc.). She will take finesses, lead to promote tricks, etc. In other words, ALICE is a decent player.

ALICE requires at least 64K of RAM and two disk drives having 160K (or more) of storage capacity.

Price: \$49.95 one (or two) diskettes

## CARD GAMES (BRIDGE)

### CASINO

(TRS-80 only)

CASINO is the card game that was in vogue prior to the advent of Gin Rummy. It is still very popular and is often taught by grand parents to their grand children.

The DYNACOMP version uses two players: you and the computer. The computer plays a fairly strong game and (of course) keeps track of scores, shuffles, deals, etc. The cards are shown on the screen using TRS-80 graphics. All the features of standard casino are included.

CASINO comes with a complete instruction manual which includes a section on the rules of the game, as well as playing strategy. If you want to learn to play Casino or are looking for a worthy opponent, here is your chance. Requires 16K (cassette), 32K (diskette).

Price: \$12.95 Cassette  
\$16.95 Diskette

### BRIDGEMASTER DOES IT AGAIN!

The BOOK OF ATARI SOFTWARE (1983 edition) gave DYNACOMP's BRIDGEMASTER an "A" for overall value for the dollar. We must be doing something right: they gave PACMAN and SPACE INVADERS a "C".

### BRIDGE 5.2

(Commodore 64 only)

BRIDGE 5.2 is DYNACOMP's most advanced addition to the BRIDGE N.N series, and was written and compiled specifically for the Commodore 64.

BRIDGE 5.2 contains many of the features of BRIDGE-MASTER™, but all in one large program. BRIDGE 5.2 both bids and plays. You may choose random hands or specify them. The bidding method is standard American and includes three level pre-emptive bids, take-out doubles, the Blackwood convention, doubles and re-doubles, etc.

During play you may choose to see only the cards normally showing or opt to see all of the hands (double dummy). You may review the cards dropped during the last round and "claim" if desired. Hands may be replayed.

Although BRIDGE 5.2 does not contain all of the features of the multi-program BRIDGEMASTER, it is a strong player and is available on cassette.

Price: \$19.95 Cassette  
\$23.95 Diskette

BRIDGE 5.2 won the first microcomputer bridge tournament for best defensive play (Midway Bridge Club, New York, January 8, 1985), and has had a hand published in the *New York Times* bridge column (January 2, 1985). Its competitors included Troup's Bridge Baron and Artworx' Bridge 4.0

### DOUBLE-DECK PINOCHLE

(TRS-80 only)

DOUBLE-DECK PINOCHLE is simply the fastest (machine language) and best-playing computer pinochle program available. You may either play in the learning mode or compete in a regular game. There are four players, with the computer supplying your partner and the opposing team. The game includes bidding, playing, scoring, and a HELP mode. If you like to "meld", you will love DOUBLE-DECK PINOCHLE.

Price: \$19.95 Cassette  
\$23.95 Diskette

## CARD GAMES (BRIDGE)

### BRIDGE MASTER II

(Apple only)

The usual customer evaluation of BRIDGE MASTER is "excellent". So what could we do to improve an already great product? Well, we *did* find a few things:

- We improved the bidding. More than 90% of the time the right contract will be bid (if you hold up your end).
- We improved the playing. Better finesses and trumping, too.
- We added more options. Anyone can be the dealer; assigned vulnerability; claiming.

BRIDGE MASTER II was tested for more than a year prior to release because of its complexity. We think you will love it!

BRIDGE MASTER II requires 48K and one disk drive.

Price: \$34.95 Diskette

Upgrade: If you have already purchased the Apple version of BRIDGE MASTER (I), you may upgrade to BRIDGEMASTER II by returning your Apple BRIDGE MASTER diskette with a check (Master Card, Visa, or American Express) for \$10 plus \$3.50 shipping and handling. Make sure the diskette is well packed!

### BRIDGE MASTER

(available for all computers)

If you liked DYNACOMP'S BRIDGE 2.0, you will absolutely love BRIDGE MASTER. BRIDGE MASTER is a comprehensive bridge program designed to provide hours of challenging competition. Bidding features include the Blackwood convention, Stayman convention, pre-emptive openings, and recognition of demand bids and jump-shift responses.

The program plays the North hand as your partner and East-West as your opponents. After playing a specific hand, you may replay the same hand, with the option of switching cards with your computer opponents. This feature allows you to compare your bidding and playing skills to BRIDGE MASTER.

A unique feature of BRIDGE MASTER is its scorekeeping capability. Points scored for each hand are calculated. Bonuses for game contracts and slams are awarded as in duplicate bridge. Doubled contracts are scored based upon a computer assigned vulnerability. Individual hand scores are tabulated and an accumulative score card is displayed at the conclusion of each hand played. The score card displays a summary of total hands played, total points scored, number of contracts made and set, and % bids made.

Requires 24K program memory (Atari version requires 48K). Available on disk only.

Price: \$29.95 Diskette  
\$32.45 8" CP/M Disk

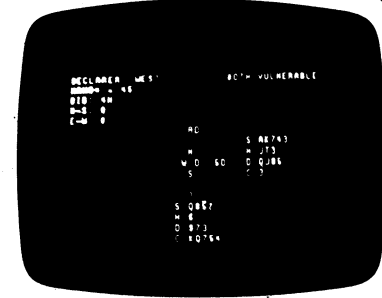



**Review of BRIDGE MASTER  
A.C.E., January, 1983**

**BRIDGE MASTER**

This program is available on disk for \$29.95 from DYNACOMP, 1427 Monroe Avenue., Rochester, NY 14618. It is an upgrade of their former Bridge 2.0. If you own the original, you may obtain the upgrade by sending them your original cassette or disk, together with \$5 plus \$2 handling. They were VERY prompt. I received the disk in what seemed less time than was required for my order to reach NY. I also sent off two pages of questions, and they were also very prompt with responses to the questions. Most of my problems with the program was due to my lack of understanding about Duplicate Bridge. I've never played Duplicate. The documentation tells you the program generates hands numbered from '0-999'. A numbered hand produces the same card distribution each time you select it. You may play the same hand as many times as desired. You may also switch positions in the same hand, and see how you may do on the other side. The documentation also tells you the '0' hand produces a random hand each time you select 0. I didn't find that to be true, and asked Dynacomp where

the random hand could be found. Their response showed me the hands were actually numbered from 0.00 to 999.99. That's 100,000 hands, instead of 1000. Who needs another random hand generator? I hope I live long enough to play 100,000 hands (not likely!). The program keeps score and saves it to a disk file so you can come back to it any time. The menu lets you display the last hand played. So if you're playing the numbered hands sequentially, it's easy to pick up where you left off. There are no graphics—it's all text. With all the scoring and reading and writing to disk it seems slower than the 2.0 version it replaces. It has added some functions not covered by the 2.0. They've added pre-emptive openings, Blackwood and Stayman conventions. The program will also recognize demand bids and jump-shift responses. These are all nice improvements. Dynacomp says "sometimes it makes dumb plays!" I can second that! It makes them by your partner, as well as by your opponents, so maybe it evens out. Little things like trumping one's own high card, setting up an opponent's loser. The program makes you look like a very good Bridge player — you can win a lot. It's good practice for someone wanting to learn to play. I think I'm a pretty good player, and I'm having fun with it.

— Jim Bumpas

**DUPLICATE BRIDGE MANAGER  
(CP/M and IBM only)**

The duplicate bridge player is often faced with the choice of going home and wondering who won, or following the strenuous session of bridge with a lengthy period of scoring, adding, checking, and looking for the reasons that the totals don't balance.

This collection of programs has been designed to assist in the organization and to facilitate scoring of a session of duplicate bridge.

To start, parameters are entered to define the game. Specifically, Howell or Mitchell movement, the number of tables, number of boards, number of rounds to be played, and whether there will be a half table.

Following these entries, the screen will show the starting table, pair and board configurations, and give movement directions. A printed copy may be obtained if a printer is available.

You enter the results of each round of play while the next round is in progress. Otherwise, all scores can be entered in one batch after play is completed. For this mode, a quick-entry option is available. Each board is handled as a batch of input. NS pair numbers are called up in turn, their opponent pair number presented, and entry of only NS score (+ or -) is needed for each play. Thus, the operator need only key in the scores reading from top to bottom of a conventional traveling board score sheet.

The program provides error recovery steps to avoid loss of data already entered and provides prompts which make it unnecessary for the operator to remember which results have been entered.

The program will summarize each board after all plays are entered, and likewise will tally the overall results after the last board's results are recorded.

The game may be terminated, and a tally initiated prior to the planned end of play should an emergency or unscheduled departure of one of the participants occur.

Factoring for varying numbers of boards played can be accomplished after the plays are all tallied.

**GIN RUMMY  
(IBM, Z-100, and C-64 only)**

This program is one of the nicest looking and best playing card games we have ever seen. The author has combined attractive graphics and sound into a program that is a match for the best Gin Rummy players around. The result is spectacular. This program is for one player against the computer. It allows knocking, laying off, and all standard game conventions.

IBM and Z-100 versions require 128K. A graphics card is not required.

Price: \$19.95 Diskette

These results (both board tallies, and the overall score summary) are presented on the screen, and stored on disk.

Any errors noted at summary may be corrected by re-entering correct values.

Other features:

- Basic key strokes per usual hand = 5
- In Mitchell Movements, either "skip" or "bye stand/relay" movements are handled. In fact, the preferred game is selected by the program upon entry of the number of tables, rounds to be played, and couples on hand.
- Incomplete movements are accommodated (e.g. a twelve-table game with only eleven rounds).
- A game in progress can be abruptly shortened (stopped) and scored.
- Variable tops are automatically handled in those cases where boards are played differing numbers of times.
- Factoring of grand tables is performed for pairs which have played fewer than the maximum boards.

Includes a very clear 14-page manual.

Price: \$ 99.95 Diskette  
\$102.45 8-inch CP/M Disk

**CRIBBAGE 2.0**

(TRS-80 Model I, CP/M, and IBM only)

CRIBBAGE 2.0 is a two-handed version of the classic card game, Cribbage. The standard rules of play and scoring are followed, and the points are announced using the traditional phrases. The score is visually shown on a standard 60-hole cribbage board which requires two "trips" to win.

The computer is a worthy opponent in CRIBBAGE 2.0. The program features excellent graphics and assembly language sub-routines for fast response in determining crib cards and meld points. The ownership of the crib is considered to get a good crib determination, and you may ask the computer for help with your crib cards.

This is an excellent program for the cribbage player in search of a tough opponent as well as the beginner wishing to learn the game and its scoring intricacies.

For a review of the TRS-80 version, see 80 Software Critique.

The TRS-80 version requires 16K; the CP/M and IBM versions (called CRIBBAGE CHALLENGE) require 64K machines (e.g., Osborne, Kaypro, etc.) BASIC is not required.

Price: \$19.95 Cassette  
\$23.95 Diskette

**M-MASTER  
(available for all computers)**

The first computer version of the card game that is favored by members of Mensa, the "high IQ club", is now offered exclusively by DYNACOMP.

While easy to learn, just as chess is easy to learn, the High IQ game demands a different approach and strategy with each new hand. In many ways, the appeal of this game is the same as the appeal that high-stakes gamblers find in Old Maid, though the games are not related in any way. There are two levels of play. At the computer's best strategy level, it may be truly unbeatable; at the normal level of play, the human has a fighting chance if he is sharp enough and willing to take chances.

To our knowledge, this is the first time that the High IQ favorite has been offered as a computer game, and joins the broad DYNACOMP library of leading software.

Price: \$15.95 Cassette  
\$19.95 Diskette  
\$22.45 8" CP/M Disk

**BLACKJACK COACH  
(Available for all computers —  
except Atari and NEC NBASIC)**

Learn and practice your blackjack skills with the "Coach" giving advice and consent. Test various playing and betting strategies. The automatic play mode uses either the basic count or the complete card counting method together with one of three betting methods. All playing options are included. Up to 6 decks per shoe. Learn to count cards to change bets and decisions. Numerous summary data displays plus up to 8 reports will reveal precisely which parts of your strategy work and which do not. Use of a printer is optional. Develop your own strategy modifications. "Practice on Screen Before Green \$".

BLACKJACK COACH includes a 30 page tutorial manual which is a value in itself.

Requires 32K. Disk version requires 48K.

Price: \$29.95 Cassette  
\$33.95 Diskette  
\$36.45 8" CP/M Disk

**POKER PARTY**

(available for all computers)

If you enjoy draw poker, then this is the software package for you.

POKER PARTY is better classified as a simulation than a game. As a simulation, POKER PARTY is an excellent (and inexpensive) tool for learning the subtleties of draw poker. As a game, it is simply fascinating!

POKER PARTY differs from most microcomputer poker games in the following two important ways. First, the level of play engaged by the computer opponents on the whole is quite high. Second, it is not just a two-handed game (how often do people play two-handed draw poker in real life!), but rather seven-handed. The usual rules of draw poker are followed, including a maximum of three rounds of betting before the draw (up to five cards), and at most three after. Aces may be used either high or low in straights, and there is a wild card.

The six computer players each have a different "personality" ranging from conservative to risk-taking. You can get to know your opponents with time, but it will require careful observation of the betting patterns. Your seating position changes from game to game. Sometimes you will follow a bluffer, other times he (she) will follow you.

Spend an evening with POKER PARTY for enjoyment, or practice for that next money game!

The POKER PARTY package also includes a 6 page manual describing how to play as well as providing information on strategies.

Requires 16K of program memory (Atari requires 24K).

Price: \$19.95 Cassette  
\$23.95 Diskette  
\$26.45 8" CP/M Disk

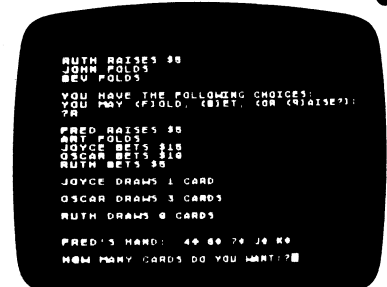

**HEARTS 2.0  
(Atari only)**

HEARTS 2.0 is a very nice two-handed version of the classic game of hearts. You and your opponent (the computer) are each dealt 13 cards. As cards are played, more cards are dealt to maintain the 13-card hands, until the entire deck is dealt. Then you play out the remainder.

HEARTS 2.0 includes three-card passing, shooting the moon (if desired), sound (excerpts from Wagner, Chopin, Schubert, Beethoven, Handel and Tchaikovsky) and pleasing graphics. Most important however, the computer is a good player and responds quickly. Also, the game is easy to learn (the manual describes the rules and strategy) and play. Recommended for ages 9 and up.

Requires 48K and one disk drive.

Price: \$19.95 Diskette

**DOMINO**

(IBM and Apple only)

The origin of DOMINOES dates back before 1,000 BC. The rules are simple and the game is fun to play. It is an easy game for children but difficult for champions.

The traditional game of DOMINOES is usually played with four people forming two teams. In the computer version, the computer takes the place of your partner and the opponents. Three levels of play are available (novice through expert).

DYNACOMP's DOMINO package includes a 28-page manual which describes the game and strategies, and which provides graphic illustrations of how the computer version is played. The program itself uses graphics to simulate the playing table.

If you want to learn how to play real dominoes, or if you want to practice the game, DOMINO is for you.

Apple requires 48K. IBM requires 128K and a graphics card.

Price: \$29.95 Diskette

Sample display (Apple):

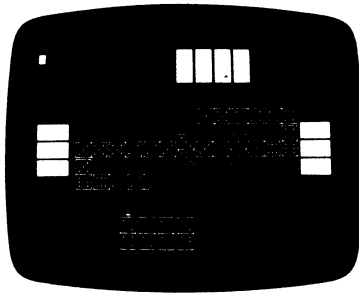
**BACKGAMMON 2.0**

(available for all computers)

This program (by Ciga, Chicago, IL) tests your backgammon skills and will also improve your game. A human can compete against the computer or against another human. The computer can even play itself! Either the computer or human can double or generate dice rolls. Board positions can be created or saved for replay. BACKGAMMON 2.0 is played in accordance with the official rules of backgammon, and is sure to provide many fascinating sessions of backgammon play.

Requires 16K of program memory (Atari requires 24K).

Price: \$19.95 Cassette  
\$23.95 Diskette  
\$26.45 8" CP/M Disk

Sample Atari display:



Color information did not photograph!

**CHESS MASTER**

(North Star, CP/M, and TRS-80 only)

CHESS MASTER is a computer program which will challenge your chess playing ability with its aggressive style of play. Written in assembly language (by SOFTWARE SPECIALISTS of Norco, California), this program employs the full graphics capability of the TRS-80 and also provides the North Star user (either Z80 or 8080 microprocessor) with two different board sizes to select from.

You may choose between five different playing skills for your computer opponent, ranging from beginner (but a tough opponent when playing "lightning" chess) to expert. Besides providing for King or Queen-side castling, en passant captures and pawn promotion, CHESS MASTER also allows you to preset the board in any configuration which you may find of interest. This allows for the examination of book situations or the replaying of interesting positions occurring during previous games.

Moves are conveniently made by entering the number of the square you are moving from and the number of the square which you are moving to. The program checks all moves for legality and then displays the moves in standard chess notation.

Requires 16K. TRS-80 version available only for Model I. Not available for IBM PC.

See review in On Computing.

Price: \$19.95 Cassette  
\$23.95 Diskette  
\$26.45 8" CP/M Disk

Sample display (TRS-80):

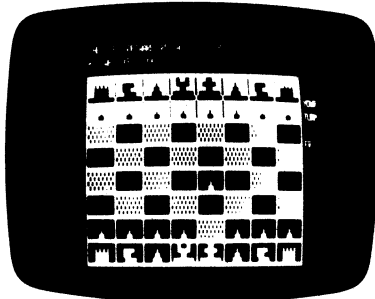
**COACH'S CORNER**

(Apple and IBM only)

COACH'S CORNER is a realistic computer football game which allows you to coach rather than play. It is your team against the computer's. There are ten degrees of play so that you may always find a competitive level.

Here is a partial list of the types of plays at your disposal:

*Offensive Running Plays:* Regular run, strong sweep, weak side run, quick draw, delayed draw, reverses.

*Offensive Passing Plays:* Screen passes, delayed strong screen, slants, down-and-in, bombs.

*Offensive Kicking Plays:* Punt, field goal attempt, quick kick, regular kick off, onside.

*Defensive Plays:* Deep, normal, dog inside, dog outside, blitz, punt blocking, tight defense, emphasized normal.

The computer calculates the outcome, keeps track of the score, field position, time remaining, downs, etc.

The outcomes of particular plays are based on the percentages of success generally observed in football games under the given conditions. You can play conservatively, or use any mixture.

COACH'S CORNER is a very educational game in that it teaches football strategy by "first-hand" experience. Playing COACH'S CORNER will help you better understand what is happening on the real field.

Requires 48K and one disk drive.

Price: \$29.95 Diskette

**PROFESSIONAL-CLASS GOLF**

(Apple only)

PROFESSIONAL-CLASS GOLF (PCG) is an accurate simulation of the game of golf at the Firestone Country Club. Each of the 18 holes in PCG is patterned after the corresponding holes at that famous course, including the greens, sand traps, and trees. You may play the course, or just practice at a particular hole. You may even practice at the driving range or putting green.

Your caddy carries a complete set of clubs, including a wedge, nine irons, and four woods. You may adjust your swing according to strength, stance, and timing; a very realistic simulation.

The computer does the work of evaluating the results of your swing, keeping score, etc. Nice graphics and sound.

Requires 64K. A color TV or monitor is suggested, but is not necessary.

Price: \$29.95 Diskette

**BOCAGOLF**

(IBM PCjr only)

BOCAGOLF is an accurate color graphics simulation of USPGA golf for 1 to 4 players. The graphic depictions of the various holes on each course are drawn to scale and include sand and water traps. Players are allowed control of direction and distance on both the fairway and green by choosing clubs. You are also given a choice of 65,000 different courses. A scoreboard is generated after each hole. During play, the player stroke number and statistics for the hole being played are maintained on the screen. There are three levels of play to challenge your skills. It is as close as you can get to real golf without the greens fees!

Price: \$19.95 Diskette

**STAR CON**

(North Star, CP/M, and IBM only)

STAR CON is a computer board game in which the objective is to conquer all 20 planets which exist on a 20 x 20 star map. The planets resist you by using their resources to build more effective defenses with time. You, in turn, can construct factories on captured planets to enhance your aggressive capability. You can move people and supplies, send out scouts, etc. Games can be saved and reloaded. The star map can be varied to create different scenarios. All of this leads to many hours of thoughtful entertainment. Requires 48K.

Price: \$19.95 Diskette  
\$22.45 8" CP/M Disk

**CASINO CRAPS**

(Atari, CP/M, and IBM only)

Whether you are a seasoned "crap shooter", wish to learn the game of craps as played in the casinos, or just want to have fun rolling the dice, CASINO CRAPS will surely interest you. CASINO CRAPS will teach you:

How to play the game of "craps"  
How to take advantage of the odds  
How many ways a number or point can be made  
What odds casinos offer on the various numbers  
The pay-offs for different odds  
The possible bet losses  
The winning combinations  
The various "craps" combinations  
And more . . .

Note: CP/M version requires MBASIC release 5.2 (or newer), and 64K. IBM version requires BASIC or BASICA.

Price: \$19.95 Cassette  
\$23.95 Diskette

Sample display: \$25.45 8-inch CP/M Disk

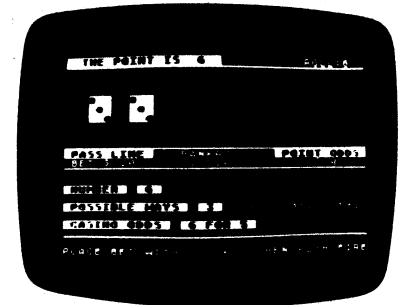
**LAS VEGAS KENO**

(Atari, CP/M, and IBM only)

KENO is the oldest game of chance known. It is played with a cage containing 80 numbered balls. A dealer draws 20, and the wagerer (before the draw) bets on which numbers will be drawn.

In LAS VEGAS KENO, the computer plays the part of the dealer and calculates the payoffs (using tables within the program). This takes much of the drudgery out of playing and speeds up the play. The program is nicely done and interesting to play. LAS VEGAS KENO requires 48K and one disk drive.

Price: \$12.95 Diskette  
\$14.45 8-inch CP/M Disk

## BOARD GAMES

### SNAKE™

(CP/M and IBM only)

SNAKE is easy to learn, with many variations and levels of difficulty—the perfect game for all members of the family. The SNAKE moves about the screen, avoiding obstacles and eating food which appears at random for a short time. As it grows, quick reflexes and mental anticipation are needed to avoid a fatal collision. Increase the challenge by speeding up the SNAKE, adding obstacles, or moving to the Advanced Game with bridges and a tunnel. The Progressive Game dares the real expert to pile up huge scores by keeping the SNAKE moving in the face of ever-increasing obstacles. A sophisticated scoreboard lets players compare their best scores.

Requires 80-column screen and 48K of RAM.

Price: \$19.95 Diskette  
\$22.45 8-inch CP/M Disk

Written by Software Toolworks

### COMPU-OPOLY

(TRS-80 only)

Hone your skill in the world of finance with this simulation of the popular Parker Brothers board game MONOPOLY™. Are you a good enough trader to drive from one to seven opponents to financial ruin? Your investments will have to be wise ones if your adversaries are computer players, because there is only one skill level—ruthless!

In addition to serving as any or all of your opponents, COMPU-OPOLY acts as both banker and games keeper. There's no need to set up a board. The computer displays everything on the screen, from the rolling of the dice to the construction of houses and hotels. Since all transactions are handled electronically, the blows are fast and furious. A typical computerized game will take only about two-thirds as long as its dining-room table counterpart.

You won't want to be caught without COMPU-OPOLY when game fanatics come to visit. Plays against itself, too. Requires only 16K (cassette) or 32K (diskette)

Price: \$19.95 Cassette  
\$23.95 Diskette

Sample display:

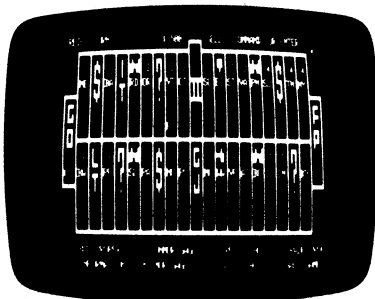

## BOARD GAMES

### MYCHESS

(IBM, CP/M, and HZ-100 only)

Now you have the opportunity to own a true world-class micro chess program. MYCHESS, best micro in the 1979 ACM North American Computer Chess Championship, and winner at the 1980 West Coast Computer Faire over such opponents as Sargon 2.5 and Atari, is now available for your computer. Nine skill levels tailor MYCHESS to any opponent. The program plays varying openings from a "book" of over 850 moves, saves a game in progress for later resumption, and prints game listing during or after the game. MYCHESS features color and monochrome graphics displays on IBM PC, PCjr, and Z-100.

Recommended for PCjr with TV adapter.

Requires 96K.

Price: \$34.95 Diskette

Written by Software Toolworks

### CHESS CLASSICS

(TRS-80 only)

CHESS CLASSICS is for serious chess players. Each disk contains 64 games which have been selected from the greatest games played in the last 200 years. You can choose to play either black or white, or have the computer play the opening moves. You are given three chances to make the right move. After that, the chess master (the computer) tells you the correct response to eventually win the game. All the chess plays are allowed: castle, capture en passant, queen a pawn, etc. You may stop a game at any point, save it, and continue at a later time.

The idea is that the best way to learn advanced chess is to replay great games of the past.

The Queen Pawn diskette contains 64 games and you have the choice of the following openings:

- Queen's Gambit
- Queen's Pawn Game
- Benoni Defense and Benko Gambit
- Nimzo-Indian Defense
- King's Indian Defense
- Other Indian Defenses
- English and Reti Openings
- Irregular Openings

The King Pawn diskette also contains 64 games with the following openings:

- King's Gambit
- Ruy Lope
- Giuoco Piano and Evans Gambit
- Alekhine's Defense
- Caro-Kann Defense
- French Defense
- Sicilian Defense

Here are some review comments (Computer Shopper):

"... the program is well written. It is obviously well researched and the product of many long hours of work. For a chess player trying to become a better player, it is a good investment."

Prices: Kings Pawn Diskette: \$59.95  
Queen's Pawn Diskette: \$59.95

Both CHESS CLASSICS diskettes are available for a combined price of \$99.95. Sorry, combination prices can not be further discounted (e.g., used in 10%-20% quantity discounts).

## FLYING

### FLIGHT SIMULATOR

(available for all computers)

Learn from this realistic, mathematical simulation which allows you to take-off, fly, navigate, and land an airplane. The program employs kinematic aerodynamic equations, as well as applies the characteristics of a real airfoil to simulate the response of flying machines ranging from gliders to space shuttles. Unlike most arcade-like animations, FLIGHT SIMULATOR realistically portrays the problems associated with stalls, landing with the nose wheel first, cross winds, etc. You can practice touch and go landings, take a cross-country trip, or just practice exercising the flight controls; flaps, trim, elevators, bank, and throttle. A program for the thinker!

FLIGHT SIMULATOR is supplied with an extensive 27 page manual which fully describes using the program. The manual also contains detailed explanations of many of the technical aspects of the simulation.

Price: \$19.95 Cassette  
\$23.95 Diskette

See review in Computronics. \$26.45 8" CP/M Disk

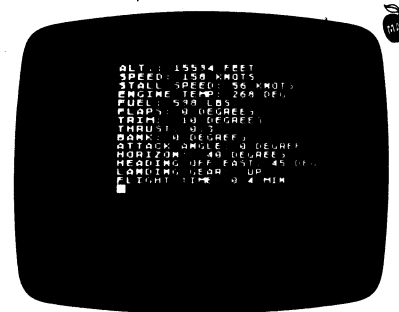

### AIRPORT™

(CP/M only)

This challenging action game tests your skill as an Air Traffic Controller. Your terminal's screen becomes a radar screen filled with aircraft under your guidance. Flight plans (landing, takeoff, or transit) are radioed to you. Guide all 26 aircraft safely through and you win. Violate FAA rules with a "near miss" and you're fired! Made it? Try it faster! Every game is different.

Requires 80-column display and 48K.

Price: \$19.95 Diskette  
\$22.45 8-inch CP/M Disk

Sample display:

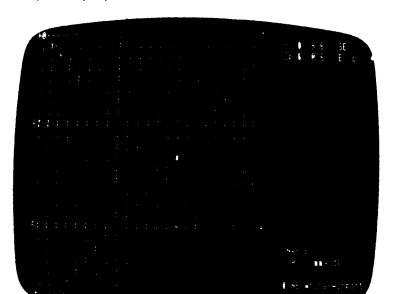

Written by Software Toolworks

## FLYING

### SENIOR AIRCRAFT CONTROLLER

(Commodore 64 only)

Simply put, SENIOR AIRCRAFT CONTROLLER (SAC) is the most realistic aircraft controller simulation available. It took 2½ years to develop, and was written by an actual controller and pilot. It has been extensively tested by other controllers, pilots, and non-aviators to ensure accuracy as well as playability.

SAC does not suffer from the limitations apparent in the many other controller simulations. For example, it includes:

- Four different types of aircraft having varying climb/descent rates and air-speed ranges.
- Weather radar, communications interference.
- Routing via a dozen beacons, holding and specific heading instructions (not joystick directions).
- Noise abatement procedures, minimum safe altitudes.
- Six different air-space maps (of increasing difficulty).
- Varying work load, efficiency points.
- A manual describing controller procedures and techniques.

With SAC you will learn to issue commands using realistic formats (sorry, no joystick or fire buttons—that's for arcade games). You will have to plan, anticipate, and worry. Your involvement will be intense, and the stress high.

You do not have to understand computers to use SAC, but you will have to learn many of the skills of an aircraft controller. The manual is designed to teach you, but you must also be willing to learn.

A printer is suggested, but optional.

Price: \$29.95

### BLACK HOLE

(Apple only)

BLACK HOLE is a visual simulation of the problems associated with closely observing a small black hole. The object of the simulation is to enter a defined close orbit about a black hole, maintain it for a given length of time, and then exit. Of course, if you use too much fuel in achieving the orbit, you may not be able to later break free.

The black hole acts as a point source of gravity. Your probe is outfitted with a main thruster and may be rotated to direct the force. The path taken by the probe is displayed so that you may better understand the interplay between the thrust and its direction, and the subsequent change in trajectory.

BLACK HOLE is not only entertaining and challenging, but is also educational. Notice how the probes speed slows towards the apogee. Is angular momentum conserved under free fall? See Kepler's and Newton's laws in action!

Price: \$19.95 Diskette

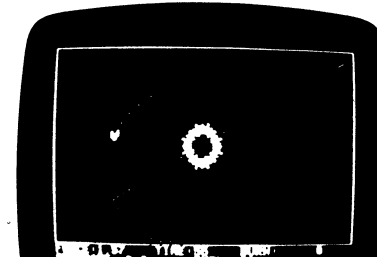

**LEIPZIG 1813**

(Atari only)

LEIPZIG 1813 is a one-player simulation of the first day of the Battle of Leipzig in Austria during 1813.

Using a joystick, the player directs movement and artillery bombardments of the combined army of the Allied nations against the computer controlled French army. LEIPZIG 1813 is a corps-level strategy game using standard military symbols to depict the Infantry, Cavalry, and Artillery units involved in the struggle. Leipzig's attack option, seven (7) levels of difficulty and three (3) levels of victory can provide the novice wargamer with an exciting game or an experienced Field Marshall with a tough, challenging battle. LEIPZIG 1813 makes wargaming easy. The computer calculates odds, combat results, and Zones of Control, as well as commanding the French army against you. This simulation requires strategy and tactical maneuvering. Average playing time is approximately 1 hour per battle. Runs in 32K (cassette), 48K (diskette). One joystick required.

Price: \$16.95 Cassette  
\$19.95 Diskette

Sample display:

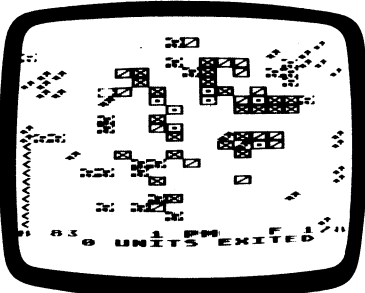
**SHILOH 1862**

(Atari only)

SHILOH 1862 is a brigade level one-player simulation of the first day of the Battle of Shiloh during the American Civil War. Using a joystick, the player directs movement and artillery bombardments of the Union Army against the computer controlled Confederate Army. The Union player is faced with the same problems General Grant had from the strong surprise attack by the Rebels and mass desertions from his ranks.

The player wins by preventing the Rebel Army from occupying Pittsburg Landing. SHILOH 1862 uses standard military symbols. It allows the player to design his/her own level of difficulty. The computer calculates combat odds and results, Zones of Control, as well as commanding the Rebel forces against you. This simulation requires strategy, tactical maneuvering, and luck. The average playing time is approximately 1.5 hours per battle.

Cassette version requires 32K; diskette version 48K. One joystick needed.

Price: \$16.95 Cassette  
\$19.95 Diskette

**WATERLOO 1815**

(Atari only)

WATERLOO 1815 is a one-player simulation of the Battle of Waterloo. Using a joystick, you command Napoleon's 'Grand Armee' against the British and Prussian forces. You are even able to direct artillery bombardments against enemy units within the range of your guns.

WATERLOO 1815 uses standard military symbols to depict your infantry, cavalry, and artillery divisions. You have 19 game turns to either decisively defeat the Allied forces or to exit as many units as possible. Ten levels of difficulty are provided, ranging from a doubled French combat strength to additional Allied combat strength. There are also three levels of victory. Additionally, the player has the option of disposing with the Prussian army before the game begins.

WATERLOO 1815 takes the drudgery out of wargaming. The computer calculates combat odds, combat results, and zones of control, as well as commanding the British/Prussian forces against you. This simulation requires strategy and tactical maneuvering. Average playing time is one hour per battle.

Cassette version requires 32K; diskette version requires 48K. One joystick required.

Price: \$16.95 Cassette  
\$19.95 Diskette

**THE SQUADRON LEADER SERIES**

(Apple diskette only)

THE SQUADRON LEADER SERIES was originally published by Discovery Games. DYNACOMP has since acquired publishing rights and has selected several members from this series for the DYNACOMP catalog.

These are not just arcade games, but detailed historical simulations. Each gives you a choice of dozens of combinations of friendly aircraft (controlled by you) and enemy aircraft (controlled by the computer). The airplanes have been carefully researched and simulated for factors of speed, maneuverability, firepower, sturdiness, and rate of climb. Success or failure depends on your ability to learn and exploit the advantages and weaknesses of every aircraft.

You control the tactics employed by your aircraft. The computer provides the opposing tactics, and takes care of the flying required to attempt these tactics. You manage the battle, just as a squadron leader would.

Includes historical perspective booklet, instructions, etc.

Requires 48K of RAM. A joystick is not required except for FLYING TIGERS.

FLYING TIGERS ..... Price: 19.95 Diskette  
WINGED SAMURAI ..... Price: 15.95 Diskette  
THE BATTLE OF BRITAIN ..... Price: 15.95 Diskette  
JAGDSTAFFEL..... Price: 15.95 Diskette  
MIGS and MESSERSCHMITTS ... Price: 15.95 Diskette

Collection: THE SQUADRON LEADER SERIES can be purchased as a collection (all five diskettes) for a combined price of \$69.95. Sorry, collections can not be included in or towards DYNACOMP's 10%-20% quantity discounts.

**THE DYNACOMP BATTLE TRILOGY**

Are you a wargamer? Do you like Atari's EASTERN FRONT? If so, you will be delighted with each game in DYNACOMP's battle trilogy: WATERLOO 1815, LEIPZIG 1813 and SHILOH 1862. Each of these simulations uses standard military symbols and pits you against a tough computer opponent. Each program, after compacting and optimizing the code, is twice as large as the very popular EASTERN FRONT. In short, both from a graphics and strategy viewpoint, these games are excellent.

Since many will want the complete set, we offer the following package price:

BATTLE TRILOGY: Three Cassettes: \$42.95  
Three Diskettes: \$49.95

**BATTLEFIELD!!!**(available for all computers  
except North Star DOS/BASIC)

BATTLEFIELD!!! is actually eight games in one. It is based on the eight disk war games set originally distributed by Xitron Systems for the North Star computer. A year ago DYNACOMP acquired the publishing rights for this software and for all conversions to other computers. During the process of translation we found that the essential features of all eight games could be combined into one group of programs which would fit on a single disk. We named this combination program BATTLEFIELD!!!

BATTLEFIELD!!! is a tactical simulation of war. You may choose one of eight battle terrains on which to play. The combatants have armies composed of both infantry and armor. The aggressor has thirteen armies, the defender, ten. The terrains include mountains, swamps, plains, slopes, rough ground and woods. The game is played by turns. During each turn a given side can move and shoot with each army. Then the opportunity switches to the other side. A particular game can end one of three ways: Time has run out; the aggressor has gained a chosen number of victory points (by damaging/destroying armies); the target has been reached.

Although BATTLEFIELD!!! is best played with two people, our programmer found that it was also very interesting to play against yourself. For those interested in a game of strategy combined with excitement, this is a good choice. Requires 48K.

Price: \$19.95 Diskette  
\$22.45 8-inch CP/M Disk

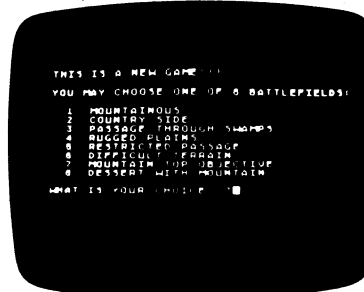

Sample displays:

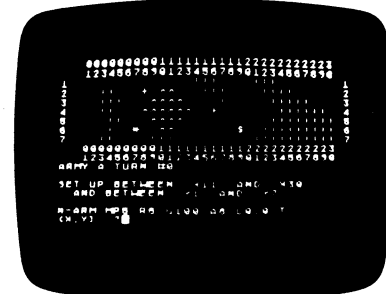
**THREAT FORCE**

(Atari only)

THREAT FORCE is a battalion-level, one-player simulation of a hypothetical battle between U.S. Army forces in Europe and invading Soviet/Warsaw Pact forces. The player controls the American units and may choose to defend with either a mechanized infantry division or an armor division. The THREAT FORCE, controlled by the computer, is composed of a motorized rifle division and a Soviet tank division. The player uses a joystick to direct the movement and artillery bombardments of friendly units and to check the attack and defense strengths of enemy units. To win, the American forces must prevent the Soviets from capturing the city of Kreisden. THREAT FORCE uses the Atari's special capabilities to show tanks, armor, etc. You design your own level of play difficulty by modifying the combat strength of each unit.

Wargamers and non-wargamers alike will enjoy THREAT FORCE. You need not know anything about wargaming to play this game. The computer will make all of the necessary calculations and execute all movement and combat actions; you simply give the orders. THREAT FORCE requires strategy, tactics, and luck. Average playing time is one hour per battle.

Requires one joystick, 32K (cassette), 48K (diskette).

Price: \$16.95 Cassette  
\$19.95 Diskette

Sample display:

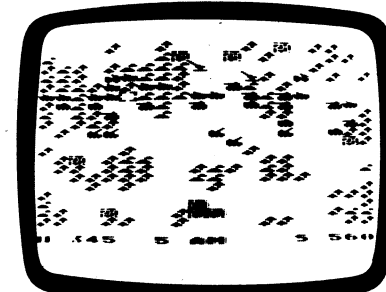

**ATTACK ON KABUL**

(IBM only)

As a Mujahidin Afghan tank commander, your goal is to recapture the capital city of Kabul from the Soviet forces using the last battle weary T48 tank left in the Resistance. You will have to battle your way out of the mountains and cross the river with your tank to reach Kabul. Should you succeed in defeating the enemy in the capital city, you will have a chance to destroy the Red Army's fuel depot on the outskirts of Kabul, forever driving the enemy into the hills where they will face the onslaught of your rebel forces. It will be a fierce tank battle, but you must succeed. Your countrymen are counting on you.

Excellent full-color graphics.

Requires 128K, color graphics card, and color monitor. Joystick is optional.

Price: \$19.95 Diskette

**SEA WAR**

(Atari only)

Quite often the best basis for a new computer program is a classic board game. The concept for SEA WAR came from "battleship". We have added graphics, sound and a formidable (but honest) computer. This is a good game for the 5-12 year old group, and many adults also find it interesting. Requires 48K.

Price: \$12.95 Cassette  
\$16.95 Diskette**IRONCLADS**

(48K CP/M systems only; e.g., Osborne, SuperBrain, NEC, North Star)

IRONCLADS is a simulation of naval strategy and tactics between steam and wind driven warships of the 1860's through 1890's. Although originally designed for two players, single play against yourself is possible.

The simulation is very complete and realistic. Each side consists of a flotilla of ships. Each ship is characterized by its speed capability, seaworthiness

(e.g., damage level) and fire power. The gunnery is very nicely modelled in terms of there being four batteries (forward, aft, port, starboard) on each ship, with each battery capable of firing different weight shells and having limited fire arcs. Ships can be trapped against the coast line or caught in port. You can even attempt to ram if all else fails.

With IRONCLADS you will gain an appreciation of the strategy and tactics involved in engaging in sea battle.

Price: \$29.95 Diskette  
\$32.45 Disk

Not available for the IBM PC.

**MISSION:  
INTERGALACTIC DIPLOMACY**

(IBM and CP/M only)

Your mission, should you choose to accept it, is to bring peace to a war-torn region of the universe. Region W-4, though remote, is close enough to galactic trade lanes that wars between planets in this region are beginning to disrupt intergalactic shipping. As a seasoned intergalactic diplomat, you have been offered the assignment of establishing diplomatic communications within region W-4, and thus bringing peace to the area.

You will have to explore Region W-4, for no maps are available. You must decide how to approach each planetary government for permission to install galactic communications: Will you try a hard sell (with threats of Federation reprisals if they are not cooperative), or a soft sell (with promises of the benefits of peace), or will

you try to bribe local officials? Or, will you just rely on bureaucratic channels to obtain the needed permits?

Your diplomatic assignment will tax your patience and persistence to the limit. Can you survive being thrown in the cargo hold of a spaceship? Can your pride survive abrupt expulsion from a previously friendly planet? However, the rewards of diplomatic success are sweet—you can see your Galactic Credits accumulate, and the Federation holds out a promise of a planet of your own to retire to.

Are you a risk taker? Bold strategies might mean quick success—or might mean ignominious defeat. Each time you play the game, a new universe, with new planets, will challenge you to try different strategies.

Requires 64K of RAM.

Price: \$19.95 Diskette

**MANAGEMENT SIMULATOR**

(available for all computers)

This program is both an excellent teaching tool, as well as a stimulating intellectual game. The MANAGEMENT SIMULATOR (by Giga, Chicago, Illinois) is based on similar games played at graduate business schools by teams of managers. The game realistically models the economic marketplace of the business world.

Each player, or team of players, controls a company which manufactures three products. The company competes against other companies, each of which sells three similar products. Each player attempts to out-perform his competitors by selecting what he perceives to be an optimum operating strategy. This strategy includes setting the following: selling price, per unit manufacturing costs, production volumes, marketing and design expenditures, plant and securities investments, as well as stockholder's dividends. The most successful firm is the one with the highest stock price when the simulation ends. The computer can also compete as a "pacesetter company". This feature is most useful when playing alone.

The MANAGEMENT SIMULATOR can either be played on-line or off-line and data from unfinished games can be saved on disk for continued play at another time. Each player will be able to study an income statement, a cash-flow report, a balance sheet, a plant report, various product reports, past-and projected-business indexes, or a competition report. It is from this information that the player can make suitable business decisions.

MANAGEMENT SIMULATOR comes with a 9-page instruction manual which includes a sample playing form.

Reviewed and recommended by EPIE Institute.

Price: \$25.95 Cassette

\$29.95 Diskette

Sample display (Atari): \$32.45 8" CP/M Disk

INCOME STATEMENT (PT 1) OF FIRM 1 IN PERIOD 0		1763281
SALES REVENUE		1763281
LABOR & MATERIAL COST	587450	
INVENTORY VALUE	6336	
MARKETING EXPENSE	270000	
RESEARCH & DESIGN EXPENSE	15000	
WAREHOUSING COST	10222	
SHIPPING COST	4382	
DEPRECIATION	15000	
ADMINISTRATION	197641	
TOTAL EXPENSES		1421741
OPERATING PROFIT		353540

REPORT/INPUT 0 09 MENU 11 END 7

**SPECULATION**

(TRS-80 only)

DYNACOMP's MANAGEMENT SIMULATOR has proven to be so popular that we decided to add a stock market simulation to our product line. Here is the market you will encounter:

There are thirty three companies grouped within eleven major industries. The companies encompass three risk ranges: growth, investment and speculative. Each player (two to four players) starts with \$15,000 in capital. Companies can merge, go bankrupt, or be taken over (by a player obtaining majority control). Rumors are given regarding splits, price changes and merges. There are annual reports, tax audits, etc.

**MASTER THE MARKET**

(IBM only)

This is a fast moving stock market game, for 1 to 10 players, that closely simulates real market conditions. Players buy and sell from a selection of 10 blue-chip stocks to see who can accumulate the most wealth. The game uses some exciting graphics, including stock price bar charts and simulation of the NYSE ticker tape. News events, randomly selected, affect the day's market.

Because the behavior of each of the ten stocks is randomly and independently generated, no two game sessions will ever be the same.

MASTER THE MARKET also maintains each player's portfolio. At the end of a trading day, each player's portfolio is appraised for net worth, and the player's performance as an investment manager is ranked with the other players.

MASTER THE MARKET can be played on either of two levels: as a regular cash purchase game or at a more sophisticated level that allows players to buy stock on margin and sell stock short.

MASTER THE MARKET is also an educational program for novice investors who are learning how to "play the market". The simulation is realistic enough to teach some important lessons before real money is committed to the stock market.

Requires 128K. BASIC is not needed.

Price: \$29.95 Diskette

**HINT**

(NEC)

When given a choice to run under NBASIC or CP/M and MBASIC, choose the latter; you will have more free memory to work in.

**YACHT RACE**

(Atari only)

YACHT RACE is a tactical game of navigation, sailing knowledge, and boat-handling skills. Using paddles (no pun intended) or joysticks, two yachts are sailed around a triangular course in a race to the finish. To achieve maximum speed, the skippers use controllers to steer the yachts and to trim sails according to the direction and speed of the wind. Hazards include rocks, course marks, a ferry, the beach, and collision with your opponent's yacht. Five courses and four degrees of difficulty may be selected. Compete against your own best time or against another player for a selected course.

Requires 48K, two joysticks or paddles.

Price: \$19.95 Diskette

SPECULATION has much the same fascination as the time honored board game MONOPOLY™. SPECULATION is more complicated, but the computer handles the accounting chores. Requires 16K.

Price: \$19.95 Cassette  
\$23.95 Diskette



**VALDEZ**

(available for all computers)

VALDEZ is a simulation of supertanker navigation in the Prince William Sound area of Alaska. It contains a detailed analysis of ship response characteristics, as well as a model of tidal patterns in the Sound. Navigation is aided by a variable range radar display with shows the land masses and other traffic (ships and icebergs). A unique feature of this simulation is the 256 x 256 element map employed. Sections of this map are peeked at using the radar display. This map feature is unique and greatly enhances the realism of the program. VALDEZ provides an interesting and educational exercise in ship navigation.

The VALDEZ package includes a 12 page manual which fully describes program operation. Requires 16K of program memory (Atari requires 24K). See reviews in 80 Software Critique, Creative Computing and Personal Computing.

Price: \$19.95 Cassette  
\$23.95 Diskette

Sample display map (Atari): \$26.45 8" CP/M Disk

**creative computing  
SOFTWARE PROFILE**

Name: Valdez  
Type: Supertanker  
System: 16K Apple, PET, Northstar,  
TRS-80, CP/M, 24K Atari  
Format: Disk and Cassette  
Language: Basic  
Summary: Excellent  
Price: \$19.95 Cass.; \$23.95 Disk  
Manufacturer:

Dynacomp, Inc.  
1427 Monroe Avenue  
Rochester, NY 14618

**MONARCH**

(available for all computers)

MONARCH is a brain teaser! You have just been elected the Ultimate Ruler of your own country. It is your job to decide the country's budget. Your country's income comes from farm produce and tourism. Half your land is farmland while also having excellent mineral content. It is up to you to decide how to manage the country's economy and to redistribute the wealth to your countrymen. Can you keep your countrymen happy enough to last in office for eight years?

Reviewed and recommended by EPIE Institute.

Price: \$14.95 Cassette  
\$18.95 Diskette

**STARBASE 3.2**

(available for all computers)

STARBASE 3.2 is a new and exciting program related to the classic space simulation many have played on "large" computers. This version is a significantly enhanced program, is more complex, and is more challenging. It was written by a visiting Croynin who decided to give his side a chance. The Empire gets even!

The Croynins have learned from their past experiences. Their task force is now composed of both light (the old style) and heavy cruisers. Some of the heavy cruisers have a proton torpedo deflection device and must be attacked from their weak side or with lasers. The croynins no longer wait to be fired on, but may initiate a battle. They also attack starbases in distant quadrants without warning and have enough fire power to eventually capture those bases unless the Invincible goes to the rescue.

The Croynins now fight battles with a much better strategy. For example, they move. Sometimes they will move behind stars and hide. Other times they close in for a close-range laser attack. Croynin heavy cruisers sometimes start a battle with low energy blasts, trying to give the impression of a light cruiser. However, when the Invincible closes in for a laser kill ... surprise!

Anyone who enjoys Star Trek™ simulations must play STARBASE 3.2.

Requires 16K program memory space (Atari requires 24K).

See reviews in A.N.A.L.O.G., 80 Software Critique and Game Merchandising.

Price: \$13.95 Cassette  
\$17.95 Diskette

Sample Display (Atari): \$20.45 8" CP/M Disk

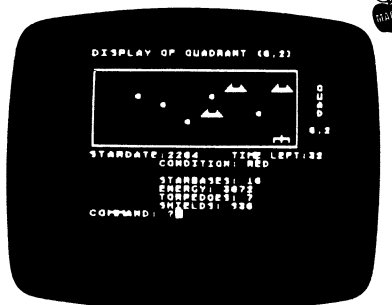
**SPACE EVACUATION**

(available for all computers)

How many people can you evacuate from Earth before the sun explodes? Your computer becomes the control console of a giant spaceship in this exciting simulation as you determine which worlds can be colonized, make those worlds habitable, and transport people through space. You have 500 years for your mission, but your ship is limited to the speed of light, and colonization takes time. Choosing the best travel routes and colonizing procedures can be critical. The goal is to save everyone. However, the highest recorded score is 97%. Can you do better?

Requires 16K of program memory  
(Atari version requires 24K)

Price: \$15.95 Cassette  
\$19.95 Diskette  
\$22.45 CP/M Disk

**WHO'S MINDING THE STORE?**

(CP/M and IBM only)

YOU ARE! This stimulating game/simulation offers you the chance of a lifetime: to own your own business — a neighborhood grocery store. Running the store is not an easy business, however, as you will find out the very first week.

Brave the perils of spoiled milk and exciting neighborhood events (such as the neighborhood reunion of a very large Italian family, or the local 4-H Club conducting a cooking class). Dare to bring high-quality merchandise and low (!) prices to your neighbors and customers.

BEWARE — running the store is a very taxing business, especially since you also have your regular job during the week. You have GOT to make the store more successful, so it can support you full time, before you have a nervous breakdown from overwork!

You do have help, however, from your loyal, hard-working clerk, who has been working in the store since before you were born. He mans the cash register, and even proffers advice. So, what are you waiting for? Get in on this ground-floor opportunity to run your own store!

For ages 10 through adult. For youngsters this program is educational; for adults it is intriguing! Printed output is available for those with printers. Requires a 64K (or larger) machine.

Price: \$19.95 Diskette

**TRIVIA CHALLENGE**

(Apple only)

If you like the popular board game, you will love TRIVIA CHALLENGE. From 1 to 4 players or teams compete in answering questions in 5 categories (Entertainment, Sports, History, Geography, and Miscellaneous). There are over 1,600 questions on the data disk.

Included at no extra charge is the Trivia Development System which allows you to create your own Trivia data disk. You can generate your own categories and questions even if you have no programming knowledge. This feature makes TRIVIA CHALLENGE a useful tool for the classroom.

Price: \$19.95 Two Diskettes

**MAGIC MATH PLUS**

(TRS-80, IBM, and CP/M only)

This is a brand new and exciting collection of BASIC programs for the hobbyist or person interested in education, mathematical recreations and challenges, and just plain fun! MAGIC MATH PLUS was written by Popular Computing columnist and mathematics professor, Dr. Michael Ecker.

Some of the titles include Super-Blackjack (the Game of 110), an arithmetical variation of ordinary blackjack; the Base Two Trick (with complete explanation); a superb financial utility (Fastloan), a loan amortization program; The Digit Prediction Trick (Casting Out Nines, with complete explanation); a Super-Fast Prime Generator based on the Sieve of Eratosthenes; a Day-From-Date program based on Zeller's Formula; another financial utility to calculate compounded interest; The Game of Score 4; computer investigations into such topics as Fibonacci numbers; plus many other simulations, programs, and challenges.

MAGIC MATH PLUS comes in a completely menu-generated format that makes it easy to use even for the first-time computer user. Press the appropriate key and your selected program loads! Later, press M and the menu returns!

Price: \$29.95 Diskette

**TRIVIA MANIA**

(Commodore 64, IBM, and North Star only)

The fun of trivia questions goes computer! TRIVIA MANIA™ has six test categories, each containing eight-hundred questions. TRIVIA MANIA™ will test your strategic skill as well as your fund of knowledge. Choose from four levels of timed play. Up to six players or teams may play at one time. Score is kept in dollars. Whether you are a trivia maniac or just a beginner, you will enjoy both the questions and play.

TRIVIA MANIA™ is also available as a board game not requiring a computer.

Commodore version requires 2 disk drives; all others require only one disk drive.

Price: \$29.95 Diskette

**USA TRIVIA**

(IBM only)

USA TRIVIA combines game format with the presentation of important geographical and historical facts about the U.S.A.

USA TRIVIA has four play modes. The first two are the same game with either one or two players. In this mode, the game resembles popular TV game shows in that the players are given clues and they have to "BUZZ" to respond. It employs full-color graphics with each player represented as an animated character. The object of the game is to capture as many states as possible by being the first to identify the correct state from the clues displayed.

The clues presented are drawn randomly from a data base of information on the disk. The unique two-player format provides a competitive atmosphere that will keep the players engaged throughout the game. The single player will be challenged to increase his or her score.

The third mode makes USA TRIVIA a unique educational program. In this game, a single player is given a state name and is challenged to select the state from the map of the U.S.A. This is accomplished by controlling an animated character which can walk anywhere on the screen. The player uses the character to point to the state selected.

The fourth presents basic facts on each of the states. It is entertaining to watch as the animated men on the screen take turns capturing the states one at a time.

You have the ability to regulate the speed of the program. This makes the program flexible; it can be a fast-moving, challenging game or a patient tool for teaching important facts.

USA TRIVIA requires 128K, and a color graphics card. It works with DOS 1.0 and newer. BASIC is not required.

Price: \$19.95 Diskette

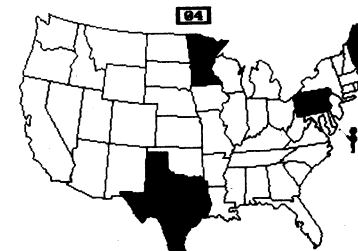

Find the state of: MARYLAND

**MOONPROBE**

(available for all computers)

Navigate your Lunar Lander to a precise (and hopefully safe) landing on the surface of the moon. This program starts you out in a stable orbit above the moon's surface. By varying the Lander's attitude and amount of thrust you direct the probe to slowly drop from orbit. You must land at the predetermined probe site. To do so accurately and without running out of fuel is quite a challenge!

Requires 16K.

Price: \$12.95 Cassette  
\$16.95 Diskette

**VIDEO BOXING**

(Commodore 64 only)

VIDEO BOXING is a 100% machine language program which is fast-paced and action-packed with realistic graphics and sound effects. You may play against the computer or against another human. The one-player option sets you against a slew of computer boxers. Your goal is to fight your way to the top and defeat the champ.

The top ten scores are recorded on the disk. Both the one and two-player versions have an individual top score screen.

You may select any one of the several computer boxers for the fight. These boxers have different characteristics. You may want a boxer with awesome power, or perhaps one with blinding speed. Maybe you want a boxer with fast gloves or a good knockout record. Pick the fighter with great endurance for those long fights. A complete description of the computer boxers is given in the boxers' history (on screen).

You may select the number of rounds (1-15) you wish to fight.

You are now ready for the big bout. The bell rings and the crowd roars. Your boxer's fate is in your hands. Will you duck or guard? Maybe you will run for your life! Try a couple of fakes! It's up to you.

Wild hair and a crazy look indicate that your boxer has gone berserk. He is wild. His punches are twice as devastating. Use this to your advantage but beware of a berserk opponent.

Now your opponent's eyes are dazed. He looks weary. A few more punches and he will be down. But the round ends and the final round begins. Both boxers are tired and slow. The score is close. Watch out for a surprise knockout. Every punch counts. Missed punches cost points. The clock has five seconds left in the fight. You don't want to face a rematch. The score is even. You have time for one last punch. Connect and you win—miss and you lose. Can you do it?

Requires at least one joystick.

Price: \$17.95 Diskette

Sample display:

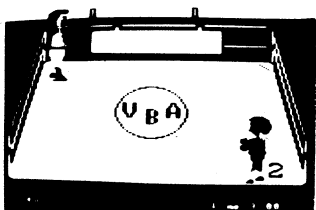
**GAMES PACK I and GAMES PACK II**

(available for all computers)

Each of these two software packages contains an interesting cross-section of traditional computer games. The packages are conveniently set up as one large program. This allows you to return to the control program after completing one game and immediately run another game without having to reload. This feature is very useful for cassette users.

**GAMES PACK I** includes simple physical models, such as CATAPULT and LUNAR LANDER; an excellent mathematical brain teaser, SWITCH; and entertaining gambling games: BLACKJACK, HORSE RACE, CRAPS, and SLOT MACHINE. Manual: 11 pages.

**GAMES PACK II** contains the popular word puzzle of JOTTO; two entertaining card games: ACEYDEUCEY and CRAZY EIGHTS; the fascinating game of LIFE plus WUMPUS, NUMBER GUESS, and CALENDAR. Manual: 7 pages.

**GAMES PACKS I and II** require 16K of program memory. (The Atari versions require 24K).

Price: \$14.95 Each Cassette  
\$18.95 Each Diskette  
\$21.45 Each CP/M Disk

**HACK and SLASH**

(Atari only)

HACK AND SLASH is an animated strategy game of crossbows, axes, greatswords, and other cold-steel weapons. One or two players can design teams of up to 8 fighters by selecting arms, armor, and fighter attributes. Teams are then pitted against each other in a large scrolling arena where animated fighters battle to the death under joystick control in this simulation of ancient man-to-man combat.

The selection of weapons and armor, the strength, dexterity, and I.Q. of the fighters, and the battle tactics that the players choose, all combine to determine which fighters will survive. Successful fighters will gain experience and monetary reward with which to buy better weapons and armor. Unsuccessful fighters die in combat and get no reward, but live again to fight in other battles.

Initial placement options allow players to set up and test various tactical formations. The sequence of play alternates between players, with each fighter able to inspect, ready weapon, move, rest, kneel, and attack.

Average playing time is one hour for a good intermediate-level battle.

Requires 48K and 1 or 2 joysticks.

Price: \$19.95 Diskette

Sample display:

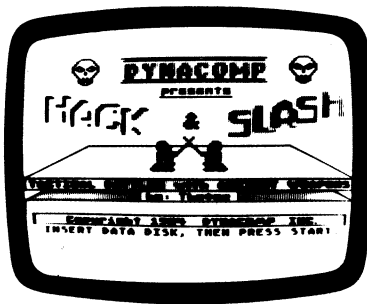
**COMMODORE GAMES PACK III**

(Commodore 64 only)

Here is a DYNACOMP package that the C-64 game player can't pass up. Included are four full-length programs: HIVES OF MARTA, AMBULANCE, POLYPS FROM PLUTO, and SUBMARINE COMMANDER. Each program makes good use of Commodore graphics, and each has a different playing style, ranging from calculating (SUBMARINE COMMANDER) to arcade (POLYPS FROM PLUTO).

Price: \$19.95 Diskette

Sample display:

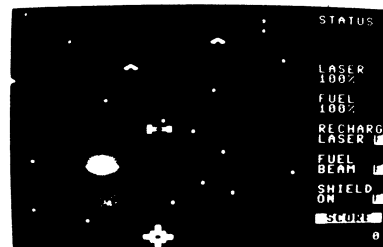
**POOL AND BILLIARDS**

(Kaypro only)

POOL AND BILLIARDS consists of three graphics programs for the Kaypro 2, 4, and 10 (1984 and newer): CAROM BILLIARDS, THREE-CUSHION BILLIARDS, and POCKET BILLIARDS (POOL).

Carom billiards is also known as French billiards or canon billiards. It is played with two cue balls and one colored object ball. Each cue ball is assigned to one of the players. A player scores one point for each shot in which his or her cue ball strikes both of the other balls. The rules for three-cushion billiards are similar to those of carom billiards, except that the cue ball must strike at least three sides of the table before striking the second object ball.

Pocket billiards, or pool, is normally played with one cue ball and 15 object balls. The players may choose any number of object balls from 1 to 15, with smaller numbers of balls providing shorter and faster games. A player scores one point for each ball driven into a pocket, unless the cue ball falls into a pocket also. If the cue ball is pocketed, the player is penalized one point, and any other balls pocketed on the same shot are returned to the table.

POOL AND BILLIARDS requires the graphics capabilities possessed by the Kaypro 10 and the newer Kaypro 2 and 4 models. Nearly all game functions are controlled with the arrow keys, the RETURN/ENTER key, and the ESC key. The arrow keys are used to control the direction of the cue stick and how hard the cue stick strikes the cue ball. The arrow keys also move the cue ball into position for the break shot and after scratching the cue ball.

POOL AND BILLIARDS can be instructive as well as entertaining. Each game is an example of a two-dimensional many-body problem in classical mechanics. All collisions are treated as perfectly elastic collisions between hard spheres, or between a hard sphere and a rigid wall. The trajectories of the balls also resemble the motions of molecules in a gas as described by molecular dynamics calculations.

For two players (you can play yourself!).

Price: \$19.95 Diskette

**COMMODORE-64 GAMES PACK IV**

(Commodore 64 only)

This is a four-game package that has something for anyone who likes to play games. In this package there is an original video game (Suicide Mission), a shoot 'em up (Arcadia Mania), an adventure game (Rendezvous at Raftco Castle), and a graphic simulation (Graphic Golf).

Suicide Mission is an original video game that should be played only by those truly skilled with a joystick. This game is TOUGH! It has thirty-two different screens of action with the added plus of being able to change the screens to what you want with the Landscape Builder program (also included).

Arcadia Mania is a blast away program that can become addicting. Are you sick of playing Donkey Kong or PacMan? Well then, play this game and blast the little critters into hyperspace.

Rendezvous at Raftco Castle is a lengthy adventure game that will keep you saying "Whoever wrote this should be shot!" With a vocabulary in excess of 120 words, you can do about anything, but just make sure you check out everything.

Graphic Golf is a simulation that didn't forget a thing. Trees, bunkers, lakes, wind, club selection, and much more are included. This isn't your standard pick-a-direction-type golf game. Depending on your handicap, the ball could go exactly where you want it to, or it could go way left or right or even short. You have to overcome the bad shots just like real golfers do.

Price: \$19.95

Sample displays:

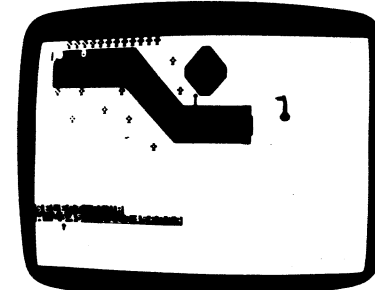
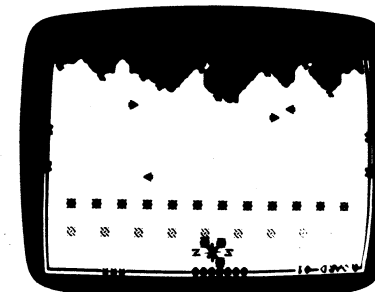

**FOR THE BEST PRICES ON EXCELLENT QUALITY DISKETTES, SEE OUR SUPPLIES SECTION. WE DO NOT SELL THE REJECTS, SECONDS, OR REDUCED SPECIFICATION DISKETTES WHICH ARE NOW BEING SOLD AT "AMAZINGLY" LOW PRICES. THEY ARE NOT SO AMAZING IN QUALITY!**

**APPLE GAMES PACK III, IV and V**  
(Apple only)

Some time ago DYNACOMP started a search through the public-domain libraries to find software which could be offered to DYNACOMP customers as a service. What we found was largely a group of half-written programs, beginner exercises, and magazine software. After reviewing many volumes of diskettes, we came up with over 300K of nice software which, after some reorganization and cleaning up, was collected into a three-diskette set. Each diskette is packed with programs, is autoboot, and contains a menu from which you may select the programs on that diskette. These packages are entertaining and well worth the low price we ask.

**Games Pack III**

This diskette contains 25 programs including:

- |                |                    |
|----------------|--------------------|
| BLACKJACK      | GOLD MINE          |
| CHECKERS       | GOLF               |
| COMBAT         | HOCKEY             |
| CRAPS          | HORSE RACE         |
| CRIBBAGE       | KINGDOM            |
| FOOTBALL       | MASTER MIND        |
| FOX AND HOUNDS | PING PONG (HI-RES) |

AND MORE!

Price: \$9.95 Diskette

**Games Pack IV**

This diskette contains 13 programs, some of which employ HI-RES graphics. They are:

- |                    |              |
|--------------------|--------------|
| ALIEN (HI-RES)     | CRUISING     |
| ANAGRAM            | DRAGON MAZE  |
| ASTEROIDS (HI-RES) | FORT         |
| BASKETBALL         | GEOGRAPHY    |
| BOGGLE             | LASER SEARCH |
| CHESS (HI-RES)     | STAR LANES   |

CRIBBAGE II

Price: \$9.95 Diskette

**Games Pack V**

This diskette has 9 programs, including one particularly nice graphics game. They are:

- |                         |          |
|-------------------------|----------|
| KING                    | OIL      |
| ATOM BOMB               | MONOPOLY |
| INSPECTOR               | OTHELLO  |
| KENO                    | SPLAT    |
| ALIEN INVADERS (HI-RES) |          |

Price: \$9.95 Diskette

**COLLECTION PRICE:** All three diskettes may be purchased for a combined price of \$25.95.

**NOTE:** GAME PACK III, IV, and V are priced too low to allow them to be applied towards quantity discounts.

Sample display:

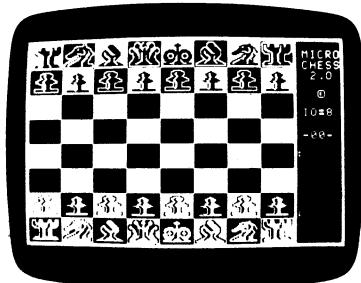

**APPLE GAMES PACK VI**  
(Apple only)

Here is one of DYNACOMP's special game collections. GAMES PACK IV (for the Apple) contains four full featured, professionally written (by DYNACOMP authors) programs which are selected from a single autoboot menu. They are:

- POKER MACHINE - A five card draw poker simulation of the Las Vegas card playing slot machines. Graphics.
- GIN PARLOUR - The classic gin rummy game which pits you against the computer. Uses standard game conventions. Includes graphics, sound, instructions for playing gin rummy.
- OFF THE WALL - A graphics arcade game similar to Atari's BREAKOUT. Requires a paddle.
- LEM LANDER - HI-RES real time graphics simulation of lunar excursion module maneuvering. Several terrains are available. Requires a paddle. 48K RAM MINIMUM.

Price: \$19.95 Diskette

Sample displays:

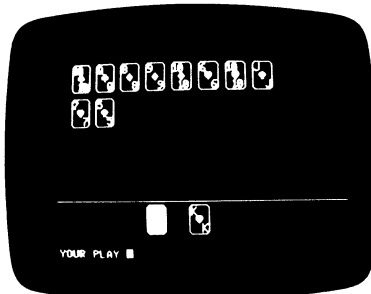

**TRS-80 GAMES PACK III, IV, and V**  
(TRS-80 only)

Here are three collections of game software written specifically for the TRS-80. Almost all of the programs are graphics oriented. Each is professionally written by a DYNACOMP author, and each is sure to please you. We expect to sell quite a few of these collections because they are such a bargain. Minimum RAM: 32K (cassette), 48K (diskette).

**GAMES PACK III**

BUY LOW/SELL HIGH - A stock market and investment simulation for 1 to 3 players. Educational, and fun, too!  
HYPERDOM - A dominoes-like game which combines coordination, graphics, and skill.

PYRAMIDS OF GAR - A graphics adventure.

Price: \$19.95 Diskette

**GAMES PACK IV**

SUBMARINE BLOCKADE - An action and sound arcade game with submarines, airplanes, mines, etc. (machine language for fast play!).

AIR DEFENSE - An action and sound game involving airplanes and missiles (machine language).

STARSHIP DOGFIGHT - This is an extremely good graphics/arcade game similar to Atari's SPACE RAIDERS. Includes sound (machine language).

Price: \$19.95 Diskette

**GAMES PACK V**

LUNAR VOYAGER - The classic LEM LANDER, but with new twists: you draw your own lunar landscape, and you must return to the mother ship after landing.

SPACE PIRATES - An action/graphics arcade game. You move and rotate your ship to fire at invading ships.

TRASHMAN - Action similar to PACMAN.

Price: \$19.95 Cassette or Diskette

**APPLE GAMES PACK VII**  
(Apple only)

Quite frankly, for this one we took three nice games which were not selling well and combined them into one offering at a small fraction of the original price. The games are GO FISH (a children's game), SPACE LANES (a strategy game), and PAPERBOY (a joystick arcade game).

Price: \$9.95 Three Diskettes

Sorry, this set cannot be included in or towards DYNACOMP's 10%-20% quantity discounts.



**COMMODORE GAMES PACK V**  
(Commodore 64 only)

Another super bargain! Four complete games, each one offering hours of fun:

- TRIVIA POKER: A trivia game for 2 to 6 players. The players enter their secret trivia guesses and bet (and bluff) on their answers.
- SIFTER SHIFTER: The rules are simple enough for a six year old, but the play can challenge a serious adult. Joystick and keyboard versions are provided.
- TREASURE FROM THE DEEP: A single-player graphics adventure. You are out to find and recover undersea treasure while fighting off sharks, etc.
- BLOCK OF BUCKS: For 1 to 3 players. A puzzle game along the lines of the game show. You buy vowels, etc. Includes a puzzle creation program.

Price: \$14.95 Diskette

**COMMODORE GAMES PACK VI**  
(Commodore 64 only)

This five-diskette set contains some great games! You will particularly like the graphics in GALACTIC BATTLES and RIVER CHASE, and you'll enjoy CHECKERS 4.0.

Contents:

- |              |                  |
|--------------|------------------|
| GO FISH      | GALACTIC BATTLES |
| SPACE LANES  | RIVER CHASE      |
| CHECKERS 4.0 |                  |

Price: \$19.95 Five Diskettes

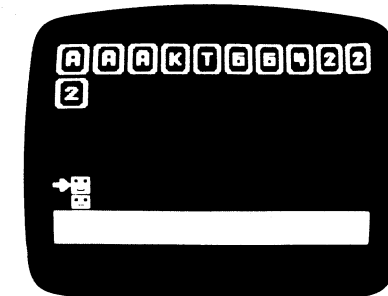

**IBM GAMES PACK III**  
(IBM only)

Here are three distinctly different games for all ages. COMPULIB: A story creator; a fun game at parties. GO FISH: The favorite of young children. SPACE LANES: A trading strategy simulation.

Formerly sold commercially as separate packages for a price of \$53.85.

Price: \$19.95 Three Diskettes

**HINT**  
(North Star BASIC)

**NO PROGRAM** or **OUT OF MEMORY** error: Either the program file is empty (unlikely) or you did not use MEMSET to allocate enough memory for the program.

## GAMES PACKS

### ATARI GAMES PACKS

III, IV, V, VI, VII, VIII, IX, and X  
(Atari only)

Judging by our experience with GAMES PACKS I and II, game collections are very popular. Therefore we have assembled eight more.

These are not public-domain programs. Each program is full-featured and has been professionally written by DYNACOMP. In addition, every title has an associated user's manual. Minimum RAM 32K. One joystick required. Each collection is well worth our low price of only \$19.95 per diskette.

#### ATARI GAMES PACK III

EUCHRE ESCAPE FROM VOLANTUM  
FOREST FIRE INTRUDER ALERT  
SPACE TRAP TRIPLE BLOCKADE

Price: \$19.95 Diskette (or six cassettes)

#### ATARI GAMES PACK IV

BACCARAT LIL' MEN FROM MARS  
MIDWAY RINGS OF THE EMPIRE  
ROLLERBALL ALPHA FIGHTER

Price: \$19.95 per Diskette or Cassette

#### ATARI GAMES PACK V

STUD POKER CRAZY CHASE  
QUINTOMINOES SUPER TANK ATTACK  
CHOMPELO SPACE TILT

Price: \$19.95 Diskette (only)

#### ATARI GAMES PACK VI

COSMOS DIAMOND HUNTER  
NEBS DRAGON BLAST  
GOMOKO DOODLE DRAWER

Price: \$19.95 Diskette (or six cassettes)

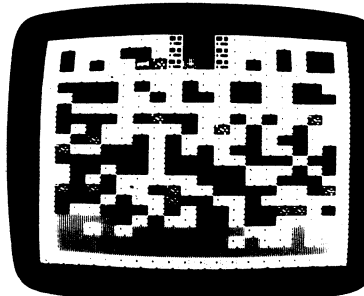
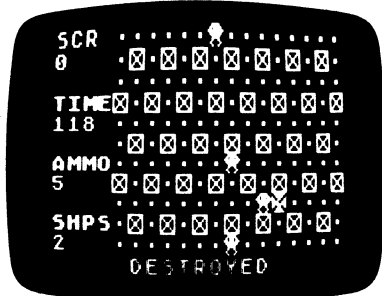
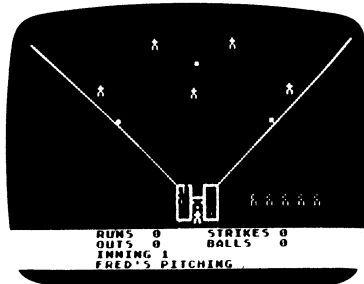

## GAMES PACKS

### ATARI GAMES PACK VII

COMPUHELLO FINAL ASSEMBLY  
ALVIN CACTUS LEAGUE  
GOLF PRO BASEBALL

Price: \$19.95 Diskette

### ATARI GAMES PACK VIII

STAR LORDS (48K) STARBASE ONE  
SUPER STUD POKER (48K) TIME BOMB

Price \$19.95 Diskette only (Three Diskettes)

Note: SUPER STUD POKER and STAR LORDS are also sold separately by Lotsa Bytes (Antic Magazine, September, 1985). They list the program values as \$29.95 and \$39.95 respectively. DYNACOMP's offer is clearly a super bargain! Just check our competition!

### ATARI GAMES PACK IX

GO FISH DIGGERBONK  
SPACE LANES THE BEAN MACHINE  
MASTER MATCH

Price: \$19.95 Five Diskettes  
(Diskettes only)

### ATARI GAMES PACK X

TYPE OUT HOPPER  
ROLL 'EM JERRY WHITE'S GAME  
PAPERBOY MACHINE

Price: \$19.95 Five Diskettes  
(Diskettes only)

### SPECIAL COLLECTION PRICE

The Atari Games Pack III-X collection can now be purchased as a set for only \$129.95. Sorry, this set cannot be used in DYNACOMP's 10%-20% quantity discounts.

## LATE ARRIVALS

### STOCKAID III

(IBM only)

STOCKAID III provides the technical market analyst with the tools to maintain, view, and study the detailed technical history of up to 64 stocks and the New York Stock Exchange (NYSE) Index on only one disk. Using only one disk you can store 250 days of data for each stock (a full year's worth) and 500 days of data for the NYSE Index. There is no limit to the number of disks you can maintain.

For each stock you enter the daily volume, high, low, and closing prices. A variety of graphic displays of stock actions and indicators are then available. In addition, other functions provide all the tools necessary for a complete technical analysis.

Clear prompts and questions guide you through the many functions. In general, you respond to prompts highlighted in green to distinguish them from other items in the displays which appear in yellow. If you should make an error (not likely!) an error message appears in white on a red band at the bottom of the screen.

STOCKAID III is written to help you avoid mistakes. For instance, in the Input Multiple Days and Enter Daily Data functions, the first prompt asks for a date. The program does a thorough check for a "legal" date. Don't try to put in February 29 except during a leap year, or a June 31 anytime. You can't fool STOCKAID III!

#### Features:

- Ticker symbol, up to 30-character company name.
- Inputs and price relationships are checked for errors and inconsistencies.
- Display of composite index, advances, declines, new highs, new lows, volume, etc.
- NYSE Index graphs: advance/decline, trend lines.
- Stock graphs: trends, on-balance volume, relative action (oscillator), volume bar, point and figure chart.
- Market and stock statistics summary.

As you can see, there is a lot packed into STOCKAID III! Includes manual, and sample data disk.

Requires 128K of RAM, color graphics card, and one disk drive.

Price: \$39.95 Two Diskettes

### EXCERPTS from a review of BUysel

(by Brian Greiner, Software Now!, April 1985)

"The manual consists of thirty-five pages... It is well written, and explains every aspect of the program fairly completely. One section I particularly appreciated, was a 'walk-through' of all the various features using sample data files to show how the program worked. The manual explains in detail the parameters used by each trading method, and gives some detailed background information for each method. There is also a brief bibliography of books the program's author found useful.

In use, Buysel is rather a lot of fun... I used the supplied data files to analyze a sample stock and commodity with no problem... Buysel is useful not only for picking the best investment strategy for a particular stock, but also useful for weeding out the dogs... The program seems reasonably crash-proof and easy to use.

Overall, Buysel seems like a useful tool for people interested in the stock market. It offers the user a number of different trading methods to choose from, and is fairly simple to use.

## LATE ARRIVALS

### HOME APPRAISER

(CP/M only)

HOME APPRAISER is designed to estimate potential market value of real property. It is intended primarily for individual homeowners and prospective home buyers. It allows you to approximate the effects of various physical, economic, and territorial factors which have some degree of impact on the overall value of your property. You supply selected information about the house (or condo) and the computer provides a depreciated value and a "bottom line" estimate of projected market value.

Multiple data files corresponding to numerous separate buildings or tracts of land can be stored and recalled for further analysis. Additional user-specified parameters allow numerical rating of the overall quality of the surrounding neighborhood, including the relative convenience of shopping, schools, etc. The program also takes into account several local and regional economic factors which affect property values and "buying power" in a general way. Fully documented instructions are included. No printer or special graphics capabilities are required.

As an aid in tracking the changing value of your largest investment, your home, HOME APPRAISER offers the appeal, simplicity, and low cost not found in most business-oriented real estate packages. The prospective home buyer can also benefit by using HOME APPRAISER as a tool to estimate and compare the values of several properties.

Price: \$29.95 Diskette  
\$32.45 8-inch CP/M Disk

### SOME COMMENTS ON IBM "COMPATIBLES"

Our guess is that there will eventually be a law requiring manufacturers of IBM "compatible" computers to specify how incompatible their computers really are. Maybe a legal case will extend "truth in advertising" to computers. (Actually, Commodore has been bitten hard by this one!) For example, so called IBM "compatible" computers with 3½" disk drives simply will not accept 5¼" disks! Also, stating that a computer is 95% compatible is frightening; does that mean that 5% of each program won't work?

We had an experience with a local dealer which perhaps reflects what many shoppers face today. The dealer first claimed that his machine was 100% IBM compatible. After some grilling he conceded that some software wouldn't run (he didn't know why) and some plug-in boards were not compatible ("You see, IBM made a mistake in the cables for their disk drives. We did it the correct way," he said.) If we hadn't known to ask specific questions about compatibility, we wouldn't have found out about the exceptions. Good grief!

What is this discussion leading up to? Simply the following: When you call DYNACOMP to place an order and you are told that the IBM software you want will not work on your "compatible", please believe us! If you are told that you may need special "ASCII" versions, again, please believe us. Every day we encounter people who have discovered problems with their IBM "compatibles". Please help us help you order the right software.

We also suggest that if you purchase an IBM "compatible", and it is advertised to be compatible, and you find that it actually isn't, complain about false advertising!

### VOCATIONAL SCHOOL SHOPWARE™ SERIES

DYNACOMP is pleased to announce the new and unique SHOPWARE™ series for vocational education. This series is designed for grades 7 through adult, and is applicable to classes in occupational versatility, general shop, industrial arts, and vocational education. It is available for the following computers:

- Apple II+, IIc, IIe, 48K RAM
- IBM PC, 128K, with color graphics card
- TRS-80 Models III, 4, 4p, 48K

All packages include diskette, teacher helps, supplemental quiz masters, and documentation in a bookshelf storage unit.

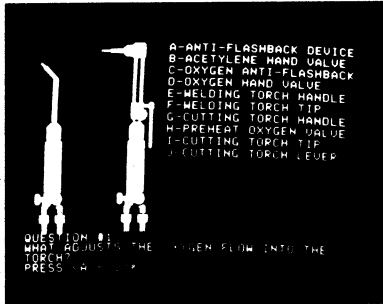
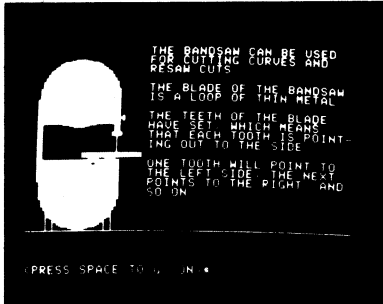

### SHOP PROJECTS PLANS INDEX

(Apple, IBM and TRS-80 only)

SPPI allows the class to have a computerized list of all the shop project plans available to those particular shop students. When students use the excuse that they don't know what to make, the computer is a fun way to select a project. They can scan a list of as many as several thousand project plans available in their own shop. The computer then refers the student to the correct book, textbook, notebook, or magazine to find the complete set of plans.

It is so easy to use that the teacher can have students enter the initial information. Included is a password-protected portion that allows the user the options of entering new information, editing existing data, erasing categories of information, or with use of a printer, producing on paper a list of plans from any category.

Price: \$69.95 Diskette

### SHOP TOOLS AND EQUIPMENT INVENTORY

(Apple, IBM, and TRS-80 only)

STEI allows the teacher to create a computerized inventory of all the tools and equipment in a school shop. At any time, the teacher or student may easily and quickly review the inventory records. The password-protected portions of the program allow the user the options of entering new information, editing existing data, erasing categories of information, or with use of a printer, listing the inventory of any category on paper.

Over 40 teacher-defined categories and thousands of individual entries may be stored on disk.

Price: \$69.95 Diskette

### STATIONARY WOODWORKING EQUIPMENT SAFETY AND OPERATIONS

(Apple, IBM, and TRS-80 only)

SWESO covers the parts, safety, and operations of the ten major kinds of stationary equipment in the woodworking shop. Each equipment program includes the use of computer graphics to explain the parts, safety, and operations of the machine, including a computer quiz. The teacher can later review the scores and print them on paper with a printer.

Equipment lessons include bandsaw, table saw, radial arm saw, lathe, scroll saw, shaper, drill press, jointer, thickness planer, and stationary sanders.

Price: \$139.95 Two Diskettes

### PORTABLE WOODWORKING EQUIPMENT SAFETY AND OPERATIONS

(Apple and IBM only)

PWESA covers the parts, safety, and operations of the five major kinds of portable equipment in the woodworking shop. Each equipment program includes the use of computer graphics to explain the parts, safety, and operations of the machine, including a computer quiz. The teacher can later review the scores and print them on paper with a printer.

Equipment lessons include electric drill, router, sander, portable circular saw, and sabre saw.

Price: \$79.95 Diskette

### BUILDING MATERIALS COSTS

(Apple, IBM, and TRS-80 only)

BMC helps students learn how to figure the costs of various building materials such as pipe, steel, plywood, lumber, molding, and other materials.

Part one is a two-lesson tutorial on how to figure the costs of these materials. Singles, pairs, linear feet, square feet, and board feet measurements are discussed. The lessons end with a quiz.

Part two is a popular way to have the computer figure the cost of materials for building a project. The program allows the teacher to store a list of up to ten types of plywood (square feet) and ten types of lumber (board feet) available in the school shop, including prices.

Part three is a password-protected section that allows the teacher to change the materials and prices available in the shop. These changes are then permanently stored in the program for use in part two.

Price: \$49.95 Diskette

### WELDING EQUIPMENT SAFETY AND OPERATIONS

(Apple, IBM, and TRS-80 only)

WESO covers the parts, safety, and operations of the five major kinds of welding equipment in the metals shop. Each equipment program includes the use of computer graphics to explain the parts, safety, and operations of the machine, including a computer quiz. The teacher can later review the scores and print them on paper with a printer.

The following welding equipment is discussed: oxy-acetylene welding, oxy-acetylene heating and cutting, arc welding, spot welding, and wire-feed (MIG) welding.

Price: \$79.95 Diskette

### WELDING ELECTRODES IDENTIFICATION

(Apple and IBM only)

WEI helps students learn about different types of electrodes and their uses in vocational welding shops. Lessons explain electrode basics and theory, color dots identification, AWS classification numbering system, and electrode care and safety.

A computerized electrode selection system is also available to the student. This very popular feature allows a welder to select the best electrode for any given set of criteria. Once the computer selects the electrode, a detailed explanation of the features of this type of electrode is made available to the welder.

Price: \$79.95 Diskette

### VOCATIONAL MATH SERIES: PREVOCAATIONAL MATH REVIEW

(Apple and IBM only)

VMS:PMR is a diagnostic and teaching program consisting of 200 arithmetic problems organized in sets of 10 problems in a multiple-choice format. The problems cover addition, subtraction, multiplication, and division of whole numbers, fractions, decimals, and percentages. The introduction explains the purpose of the program and gives clear instructions for problems. Student score for each of the sets establishes a profile of the student's skills and weaknesses.

The second part of the program consists of tutorials for each of the sets, complete with full explanations and numerous examples. Its purpose is to provide a good review on those parts of the program in which the student is deficient.

Price: \$89.95 Diskette

### CAREER SERIES: WELDING

(Apple and IBM only)

Now students can learn about a career in welding by using a computer. This menu-driven package includes: "Career Opportunities in Welding"; "Is the Career of Welding for You?"; "Welding Safety and Working Conditions"; "Training Requirements for a Welding Career"; "Welding's Part in Industry and Everyday Life". This software tutorial is ideal for the nonshop class that wishes to develop welding career awareness or a perfect supplement for any shop class that already uses welders. Each lesson is followed by a computer generated quiz. Student scores are automatically recorded and may be printed on paper with a printer.

Price: \$79.95 Diskette

### AUTO BODY SHOP SAFETY

(Apple, IBM, and TRS-80 only)

ABSS covers the safety procedures required in an auto body shop. Text and computer graphics explain the shop safety rules, fire safety equipment, wire-feed (MIG) welding safety, and careful use of auto body tools. Each lesson includes a computer quiz. The teacher can later review the scores and print them on paper with a printer.

Price: \$79.95 Diskette

### AUTO MECHANICS SHOP SAFETY

(Apple, IBM, and TRS-80 only)

AMSS covers the safety procedures required in an auto mechanics shop. Text and computer graphics explain the shop safety rules, fire safety equipment, oxy-acetylene welding safety, and careful use of auto mechanics tools. Each lesson includes a computer quiz. The teacher can later review the scores and print them on paper with a printer.

Price: \$79.95 Diskette

### DISKETTE RECOMMENDATIONS

We have noticed that some brands of diskettes work better than others, seemingly independent of the manufacturer's advertising or pricing (whether they are guaranteed for 90 days, one year, or five years apparently makes no difference in the failure rate). All we can say is that DYNACOMP uses (and sells) only those diskettes which it has found to be most reliable, given some cost constraints. There are some brands which are very high quality and very expensive, but the difference in perceived reliability may not be worth the difference in price.

However, we do *not* recommend that single-sided diskettes be used (in single-sided drives) on the second side by cutting an extra notch. Although many people have done this with some success, they are taking a chance. The problem is *not* "print through"; the diskette is more than thick enough to prevent that. The problem is *not* using a side that has not been verified; you can do that verification yourself. The problem is the direction of disk rotation. When you remove the diskette and flip it over, you reverse the direction of rotation. There two things wrong with doing this.

First, the diskettes are polished by the manufacturer in one direction, the direction used in your drive in the normal mode. When the diskette is flipped, it runs the opposite way. Consider your hand to be the head, and a cat to be the diskette. When you brush the cat one way, your hand glides over the fur smoothly. When you brush it in the opposite direction, the fur fluffs up and there is more resistance. Simply put, you run the danger of shortening the life of the "good side" of your diskette, as well as increasing head abrasion.

Second, the inside of the diskette contains a porous liner which picks up and traps dirt. Flipping the disk over and running it "backwards" may dislodge some of the debris, which may pass under the head or stick to it.

Therefore, although this is an unpopular view, DYNACOMP recommends that you do not try to save money by using the back side of the diskettes in single-sided disk drives. Diskettes are inexpensive enough (see DYNACOMP's prices!) that the risk is not worth the anticipated savings.



### COMMODORE 64 PUBLIC DOMAIN (C-64 and compatibles only)

Although there are literally millions of Commodore 64 computers in the world, the amount of public domain software available for this machine is very limited (compared with CP/M, Apple, Atari, and IBM). The reason for this is probably the extreme slowness of the 1541 disk drive: making a copy of a C-64 disk takes 4 to 20 times longer on a 1541 than on an IBM drive (and the IBM disk holds more!). Using the Butterfield COPY/ALL program, some disks (full ones) take 40 minutes to copy! This greatly limits the ability of user groups to distribute their libraries. They simply cannot afford the time to make thousands of copies, or the money for high-speed duplicating equipment.

DYNACOMP is going to partially fill the void with the following collection. These disks are for sale only. We decided not to offer the collection for rental. The wear on disks in the 1541 drives is so great that rental disks would not hold up well enough.

The copying fees below reflect both the extra cost of double-density high-quality disks (the 1541 is sensitive to disk quality) and extra effort in disk duplication.

QUANTITY	PRICE per Disk
1 - 5 disks	\$12.95 ea.
6 - 10 disks	\$9.95 ea.
11 or more disks	\$8.95 ea.

The complete set is available for \$199.95.

Sorry, these disks cannot be applied toward the 10%-20% quantity discounts shown on the order form.

Note: The following are only partial listings. These disks contain a lot and we have indicated only the basic contents.

When you order, clearly specify which disk(s) you want (for example, C64-3). Be sure to use the C64 prefix with the disk number; we have several public domain collections.

- C64-1 BUSINESS: Amort. tables, bonds, depreciation, gross pay, calendar, stock market.
- C64-2 COMPUTER SCIENCE: Random-number generator, turtle graph, history quiz, strings.
- C64-3 ENGLISH: Hangman, antonyms, haiku, concentration, poetry, "a" or "an".
- C64-4 ENGLISH: Misspelling, punctuation, verb forms, adverb forms, medial vowels, homonyms.
- C64-5 ENGLISH: Problem pronouns, nouns, parts of speech, plurals.
- C64-6 ENGLISH: Rhyming, hyphenation, spelling errors.
- C64-7 ENGLISH: Spelling bee, spelling tutor, synonyms, syllables, vocabulary.
- C64-8 ENGLISH: Word-search games.
- C64-9 GAMES: Civil War, duck shoot, artillery, black box, cyclon battle, dam busters.
- C64-10 GAMES: Hangman, mastermind, matches, pizza, rotate.
- C64-11 GAMES: Snakes, snark, snerd, warehouse, tower.
- C64-12 HISTORY: Ancient history, elections, famous people, presidents.
- C64-13 MATH: Addition and subtraction, ANOVA, vectors, drill.
- C64-14 MATH: Base change, Bairstow, brain crane, balance, bonds.
- C64-15 MATH: Equations, factors, fast math, hexdec, exponents.
- C64-16 MATH: Integers, lazer math, linear equations, making change, ladder multiplication.

- C64-17 MATH: Planes, matrices, micromath, metric, meter reading, points.
- C64-18 MATH: Resultants, probability, prime numbers, significant digits, roots, slope and intercept, shapes.
- C64-19 MATH: Statistics, triangles, times tables, slope/intercept, small math.
- C64-20 GEOGRAPHY: England, Italy, states and capitals, world capitals, mileage.
- C64-21 SCIENCE: Boyle's law, actinium decay, azimuth and altitude, Bohr atom, bouyancy.
- C64-22 SCIENCE: Cylinders, circuits, fuse, eler ents, equations, Geiger counter.
- C64-23 SCIENCE: Interference, ions, periodic table, molar, metric volume, microscopy.
- C64-24 SCIENCE: pH problems, photosynthesis, pollution, specific heat, stoichiometry, S.I. conversion.
- C64-25 SCIENCE: Electrical power, Ohm's law, circuits, resistors, light meter.
- C64-26 UTILITIES: Assembler, disassembler, backup 1541.
- C64-27 MISCELLANEOUS: Disk doctor (nice!), life expectancy, piano-64, bio/printer, dual copy, fast match, African adventure, 1,000 miles.

### DYNACOMP CP/M and IBM PUBLIC DOMAIN DIRECTORY

One of the problems with providing over 1,000 volumes of public-domain software is that it is impossible to adequately describe the contents of each volume in the DYNACOMP catalog. Also, since DYNACOMP's prices are so low, we cannot afford to have our order department spend the time to describe the contents of each volume over the phone (even if they could without becoming confused by the sheer number of programs!)

In an attempt to help improve the situation and provide you with more information, DYNACOMP has prepared a 480-page public-domain software directory. This directory lists over 700 volumes (over 12,000 files!), with a one-line description (in most cases) for each file.

We thought about distributing this information on disks but found that (1) it was cheaper to print the information and (2) the hard-copy format is much easier to use.

This directory covers the following public-domain software sets:

- IBM PC-BLUE, Volumes 1-131
- IBM PC-SIG, Volumes 1-370
- IBM PC-GREEN, Volumes 1-42
- CP/M User's Group, Volumes 1-92
- SIG/M (CP/M), Volumes 1-209
- PCNET (CP/M), Volumes 1-34
- KUG (Kaypro CP/M), Volumes 1-25
- Apple CP/M, Volumes 1-25
- PASCAL/Z, Volumes 1-22

If you are interested in building an IBM or CP/M public-domain library, or just finding out what is available, you will find this directory indispensable. Comes punched for a standard 3-ring binder.

Price: \$14.95

### PC-SIG SOURCE NOTICE

NOTE: The PC-SIG public domain collection was not developed by DYNACOMP but by a company of the same name. They have not authorized DYNACOMP to distribute this software because DYNACOMP's low prices have cut into their business. Needless to say, the PC-SIG company is annoyed with DYNACOMP.

### PC-SIG PUBLIC DOMAIN SOFTWARE FOR THE IBM PC (IBM only)

Here is a large collection of public domain diskettes for the IBM PC which you may either purchase or rent from DYNACOMP. Some of the diskettes are in the "freeware" category; the author encourages you to make a donation to him or her if you like the program. In any case, these diskettes contain a great deal of software which you may be able to use directly or can modify to suit your needs. These are user-donated programs and are not necessarily as nicely done as the corresponding commercial programs (i.e., no guarantees!).

The format used is MS DOS and PC DOS 1.0/2.0/3.0 and one side/two side compatible.

You may purchase individual diskettes, purchase the collection in parts, or rent it in parts according to the following schedule:

Item	Purchase Price	Ten-Day Rental Price
Individual Volumes	\$5.95	Not available for rental
Collection A Volumes 1-100	\$399.95	\$99.95
Collection B Volumes 101-200	\$399.95	\$99.95
Collection C Volumes 201-300	\$399.95	\$99.95
Collection D Volumes 301-370	\$299.95	\$79.95
Complete Collection Volumes 1-370	\$1199.95	\$329.95

If you decide to take advantage of the collection discount prices, the following payment condition applies: payment must be by Master Card, Visa, American Express, money order, or certified check.

For those choosing the 10-day rental approach, the following conditions apply:

1. Only Master Card, Visa, and American Express will be accepted.
2. There is a \$10 per day late charge if the library is not returned on time. Your charge account will be billed for each day the library is overdue, up to the purchase price of the library. Please appreciate the need to have the library returned on time (so that it can be sent promptly to the next renter).

Sorry, these diskettes may not be included in or used toward DYNACOMP's 10%-20% quantity discounts.

Be sure to carefully specify the volumes you want (e.g., PC-SIG#27; PC-SIG Collection A, #1-#100; etc.).

- #1. YAHTZEE, BLACKJACK, PATTERNS, KALEID, PINGPONG, and more!
- #2. Spooler to allow use of computer while printing. Disk cleaning program and instructions for unprotecting a BASIC program. Typewriter emulator. Function key re-assignment program.
- #3. RATBAS, to allow the creation of structured BASIC programs. Supports named GOTO labels. Includes documentation file.
- #4. DBMS, a data-base program, and MODEM7, a modem control program. Also SURVIVAL, an Adventure-type game.
- #5. PC-FILE 9.0, a popular user-supported data-base program. Includes documentation (on diskette).
- #6. FREE1 Ramdisk, reference guides for BASIC and DOS and several hardware checkout routines. Profiler routine for determining how much time is spent in which part of a BASIC program.

- #7. EXPLIST: prints BASIC programs in an easy-to-read format.
- #8. CROSSREF to print cross reference of variables used in a BASIC program.
- #9. SQUISH to compact BASIC programs to reduce space and increase speed. CRK4, a file checksum program. WASH, a disk file maintenance program.
- #10. CHASM 2.01, a user-supported assembler with tutorial and documentation.
- #11. Color graphics demo. Heapsort demo. LANDER, DEFEND, NIM.
- #12. More color graphics demo programs. To be used with diskette #11.
- #13. STARTREK, PDRAW graphics draw program with documentation.
- #14. BASMENU, an automatic menu-generating program. MENTOR, VisiCalc templates for taxes, plotting, and home budget. Bar chart creation program.
- #15. PCMAN. COLORDEM, a good example of color graphics and animation written in BASIC.
- #16. PC-TALK Modem communications package with documentation. MASTERMIND, CRAPS, and another STARTREK.
- #17. SURVIVAL, MENTOR, BREAKOUT, and more!
- #18. IQBUILD educational programs: reading, math, and language skills. Mastermind and TRUCKER games.
- #19. RV-EDIT, a screen editor written in BASIC. Program control system.
- #20. DRAW, color versions of HANGMAN, BLACKJACK, OTHELLO, YAHTZEE.
- #21. PC-MAN using joysticks, and PACGIRLA.
- #22. CHECKDIR, a directory maintenance program. BMENU to create menu for running BASIC programs.
- #23. League Secretary Bowling, STARWARS, VisiCalc tax template.
- #24. TICTACTO, RUBIC, TOWERS, WUMPAS, JAMMER, OPERATOR, NEWTREK.
- #25. 25 miscellaneous financial programs, printer utilities.
- #26. Book index utility with Pascal source code.
- #27. ZOO sort, an educational sort demo using color graphics. Also FOILS, TREK, and AUTHOR.
- #28. DISKMODEF to examine and modify any sector on the disk. VDEL to selectively delete disk files. Updated SQUISH program. Function key handler.
- #29. Set of 15 financial programs. Calculate loan balance, critical paths, curve fitting, mean and standard deviation, income averaging, and more.
- #30. PASCAL programs to demonstrate how to do disk I/O.
- #31. MVP-FORTH - Mt. View Press Public Domain FORTH language.
- #32. Screens for MVP-FORTH. Includes source code for FORTH editor and assembler. This disk is not a DOS file formatted disk. Must be used with MVP-FORTH disk #31 above.
- #33. Modem and printer utilities. GRAFTRAX, a graphics printer dump. SCROLL to scroll specified areas of screen. BSR remote control program.
- #34. SDIR22 - directory list utility for DOS 2.0, PC-TALK enhancements. Source for RAMdisk program.
- #35. STARS, GOLF, ZAP-EM, KINGDOM, TRAP, LEM, LANDER, STORY, DESERT, DECIDE.
- #36. Pascal utilities—numerous examples of Pascal on the IBM.
- #37. ATTACK, GALLERY, SPINOUT, and others.
- #38. SPOOLER, FILTER, WordStar to DOS file conversion utility.
- #39. JETSET flight simulator.
- #40. Stock market analysis programs.
- #41. Kermit communications package. Incorporates error correction protocols for use with compatible main-frame systems.
- #42. Extensive documentation for Kermit system. 290K bytes.
- #43. Exidy word processor demo with tutorial. Demo will do everything but save files.
- #44. HOBBIT, BLKFR13, BIORYTHM, SLOT,

MSQUARE, BANNER, HANOI, ROCKET, HORSE, CHASE, 21.  
**#45.** AWARI, SQUARE, REVERSE, TRADE, FOOTBALL, HIDESEK, SWARMS, TAXMAN.  
**#46.** CLOCK screen formatting program. MEMDUMP memory dump program. HIDEFILE to undelete and unhide files. File download program. Printer parameter setup routines for C-Itoh and Epson printers.  
**#47.** Wizards CASTLE game, FINPAK, graphics dump, PLOTing program. Mailing list program. Programs for setting and reading the Hayes chronograph.  
**#48.** Runoff text formatter written in BASIC. Rubic's cube simulation. Another formatted BASIC lister. FORTH language written in BASIC.  
**#49.** FINISH text formatter. HEARING tester, JOY-STICK, SPINOUT. On-screen digital clock. Calendar program.  
**#50.** Text formatter written in C assembly language source code for SDIR disk directory program.  
**#51.** HYPERDRIVE RAM disk with source code. GOMUKU in Pascal, FOUR (game). Future date prediction routine.  
**#52.** Utilities for cleaning up downloaded programs. Program for packing and unpacking in HEX format for communications of binary files. Several printer and keyboard utilities.  
**#53.** BASIC programs to generate many different sounds, WordStar utilities, number base conversion program and sort demos.  
**#54.** XMODEM with source code. Modifications and tutorial for IBM Asynchronous Communications Program.  
**#55.** CRAZY8, IPOKER, HRSERACE, LANDER (using color), JET-PILOT, BIO, ROULETTE.  
**#56.** Keyboard utilities, DISTAR, SPEECH, Print proverbs. Mini word processor.  
**#57.** Text Processing tools - Volume 1. TRANSLIT, SORT, FIND, CHANGE, and COMPARE. Programs on this disk and #58 were derived from the book "Software Tools in Pascal".  
**#58.** Text processing tools - Volume 2. FORMAT, DEFINE, MACRO, EDIT.  
**#59.** PEPSON text formatter. Fast screen print routine and a quick reference template generator.  
**#60.** Several user-supported programs. UTIL, a program to manipulate text files. MAKE to convert Easywriter 1.1 text files into DOS file format. BASREF to produce BASIC cross reference listing.  
**#61.** PRINTGR, a program to dump graphics on printer in a vertical or horizontal format (source code provided), several IPCO games and utilities. STATCAPS, a color graphics state capital matching game.  
**#62.** Programs for handling a mailing list, cash accounting, and home inventory. PC-TALK II mods.  
**#63.** Removed: in violation of copyright laws.  
**#64.** DESKTOP Vol. 1 - Managers' desktop template for use with Lotus 1-2-3 version 1A.  
**#65.** DESKTOP Vol. 2 - Documentation and instructions for DESKTOP template on #64.  
**#66.** Ginaco programs - 56 utilities and demos. Too many to list. Printer utilities, games, conversions, demos - a good introductory disk. Programs may be selected from a menu.  
**#67.** PC-TALK 2.0 modifications. NONLIN to perform a non-linear least-squares fit to data. Simple plotting program. Label maker.  
**#68.** Wordflex word processor. Finally a user-supported word processing system rivaling those costing many times more.  
**#69.** Designer - a user-supported graphics system to create graphics and animation on color display.  
**#70.** DISKCAT cataloging program. Sort and directory manipulation programs. Epson printer demos.  
**#71.** MEMORY, SPELLER, WIZARD, LOSTGOLD, DROIDS, and more!  
**#72.** DOCTOR, ROADRALY, TICTACTO, FIFTEEN, RUBIK, and more!  
**#73.** 3-D Graphics. WINDCHIL calculator. Sub-routines to test and set shift keys from BASIC.

**#74.** Library of Pascal callable utilities with manual on disk. Some sample object modules which may be included in user programs.  
**#75.** Interactive demonstration of the Forms Manager data-base program.  
**#76.** History, education - Quest to create new lessons. Data files for HISTORY.BAS.  
**#77.** IRD - Modem communications from author of PC-FILE. Setup command and batch file for printing documentation.  
**#78.** PC Write - condensed manual, expand, EO, PR, and DOC files.  
**#79.** RAM Drive - quad RAM, KEYLOC, graphics designer, utilities, and games.  
**#80.** Utilities - ALTER, ASK, BIGANSI, COLOR, EDITNO, and too many others to list.  
**#81.** Communications HOST 2 upgrade, MODEM, SCNMAT, SORTS, UNWS, and others.  
**#82.** Batch file utilities - too many to list.  
**#83.** Utilities, games, graphics.  
**#84.** Utilities: CHMOD, DOWDF, DRAWIT, FILECMD, FPR, KILL, QPRINT, TXTPRO, and how to unprotect VisiCalc.  
**#85.** VisiCalc templates and SORTDIF sort programs.  
**#86.** Screen text editor - AUTOEXEC, MMOUSE, SCREEN, PRTLP1, and INSTALL.  
**#87.** Programmer's Calculator - GC, MANUAL and DUP to copy files to another disk.  
**#88.** EPISTAT Statistical Package - too many files to list.  
**#89.** Tools - COLOR, Mailmerge, mini calc, MSPOOL, PC file, Folser (Volume Labels), XUP.  
**#90.** Genealogy Package - 25 files.  
**#91.** Adventure Game and others.  
**#92.** Music - patterns on graphics display, sound generators affd VISICALC load info.  
**#93.** ASMGEN - games, loan analysis, and flashcard drill.  
**#94.** LADYBUG - a user-supported version of Logo.  
**#95.** Math Tutor - enhanced version for 2.0.  
**#96.** The SOURCE Introduction - 9 files.  
**#97.** The SOURCE - 18 info files including accessing BBS.  
**#98.** SOURCE/COMPUSERVE Phone numbers as of November, 1983.  
**#99.** Public BBS/COMPUSERVE IBM-SIG as of 11/83.  
**#100.** BAGPIPES, JUKEBOX (music), ALIEN, 3D, TICTACTO, several adventures.  
**#101.** Portsworth stock portfolio management system, in BASIC.  
**#102.** Accounting package written in dBaseII.  
**#103-104.** Compuserve and BBS sampler.  
**#105.** PC Professor BASIC language tutorial.  
**#106.** Disk cataloging system: finds, sorts, etc.  
**#107.** FOS home finance system. Requires BASICA.  
**#108.** Programs in BASIC and APL, DOS 2.0 information.  
**#109.** Trace breakpoint, 123 worksheet for 1040, hex dump, screen/file utilities.  
**#110.** Hex/binary converter, printer setup, RAM disk.  
**#111.** 100-digit precision calculator, calendar, directory label print, DOS WordStar converter.  
**#112.** PC-CODE encrypt/decrypt, computer security, screen utilities (color to monochrome convert, etc.).  
**#113.** PC-COMPARE, color to BW converter, screen utilities, key re-definition.  
**#114.** LOTUS 1-2-3 curve fitting, assembly language tutorial.  
**#115.** File compression/decompression, PROKEY for LOTUS 1-2-3.  
**#116-117.** Micro Gourmet food database. Requires dBase II.  
**#118.** QSYS DOS menu and security package, version 2.0.  
**#119.** ABC database package.  
**#120.** PC-CHESS.  
**#121-23.** PC-FILE references to various magazines; PC-FILE format.  
**#124.** Extended BATCH language, version 2.0.  
**#125.** HOST-III BBS.

**#126.** dBaseII utilities.  
**#127.** PC-Musician for creating and playing music.  
**#128.** Games, dBaseII utilities.  
**#129.** PC-DIAL modem communications.  
**#130-132.** PASCAL tools (described in Software Tools in PASCAL). Source code included.  
**#133.** Ultra disk utilities, version 3.0: directory restoration, formatting, etc.  
**#134.** C program checker, LISP interpreter.  
**#135.** BBS utilities, BASCOM fixes, PASCAL DOS access and other utilities.  
**#136.** PC-PICTURE graphics package.  
**#137.** Full screen editor in C, with source.  
**#138.** Lattice C utilities.  
**#139.** Disk cataloger, graphics utilities.  
**#140.** DOS utilities, 1-2-3 flowchart template.  
**#141.** Text file to 1-2-3 conversion, BASIC programming aids.  
**#142.** .ASM and C routines, LISP interpreter in PASCAL.  
**#143.** BBS utilities.  
**#144.** Fabula-1, directory display, squeeze/unsqueeze.  
**#145.** Fabula-2, bypass power-up memory test.  
**#146.** EASY WRITE word processor, label filing.  
**#147.** SDB simple database system in C.  
**#148.** XLISP in C with source code.  
**#149.** Program checker, reference utility, other programs in C with source code.  
**#150.** IBM BBS  
**#151.** Finance Manager.  
**#152.** RBBS (yet another BBS).  
**#153.** Large vocabulary hangman.  
**#154.** Picture files to be sent to printer.  
**#155.** Task planner, budget tracker, loan analysis.  
**#156-158.** IBM users' group newsletters 1-3.  
**#159-161.** PC Firing Line magazine-on-a-disk, issues 1 and 2.  
**#162.** RASCAL BASIC programming aids.  
**#163.** Text filters in C.  
**#164.** Personal finance manager.  
**#165.** Personal General Ledger; requires LOTUS 1-2-3.  
**#166.** Macro assembler tutorial, disassembler.  
**#167.** BASIC utilities.  
**#168.** Algebra, chemistry, songs, spelling bee, etc.  
**#169.** Mailing list programs.  
**#170.** Spreadsheet programs.  
**#171.** Inventory program, investment analysis.  
**#172.** Assembly language utilities, editor (with PASCAL source).  
**#173.** Arcade games, ESP tester.  
**#174.** Games: FROG, CIA, CIVIL WAR, SEAWOLF, SOLITAIRE.  
**#175.** Games: CHECKERS, ALIEN, HUSTLE, NAME THE TUNE.  
**#176.** Graphics demos, space invaders-type game.  
**#177.** Arcade games: BUGS, BREAKOUT, etch-a-sketch, more.  
**#178.** Games: CHESS, AWARI, more.  
**#179.** Pizza recipes, check register.  
**#180.** Many math and statistics programs.  
**#181.** Keyboard utilities.  
**#182.** Easyfile file manager.  
**#183.** DOS utilities.  
**#184-185.** Disk utilities.  
**#186.** Screen and printer utilities.  
**#187.** Communications utilities, auto dialer.  
**#188.** MINITEL communications system.  
**#189.** TECH PRINT for WordStar printing on EPSON FX.  
**#190.** Text editors.  
**#191.** DVED screen editor, EASEL drawing program, graph generators.  
**#192.** Health risk appraisal (Center for Disease Control).  
**#193.** Text files for will creation.  
**#194.** FOGFIND (to measure text clarity), C routines.  
**#195.** Graphics programs: GRAF2, SKETCH.  
**#196.** BBS utilities.  
**#197.** BBS utilities, communications program.  
**#198.** RAMDISK (a very good one), CASTLE game (interesting features).

**#199.** PC-CALC spreadsheet.  
**#200.** Printer picture files, information files.  
**#201.** POW word processor. WordStar to ASCII conversion.  
**#202.** MIT/ISI communications package.  
**#203.** Games: ASTEROID, FLY, LUNAR LANDER, SOLITAIRE, SURVIVAL, ADVENTURE, more; require BASIC.  
**#204.** Fast copy, spooler, file protect.  
**#205.** Directory maintenance facilities, command program, cursor shape, EDLIN doc.  
**#206.** Machine language string sorting system, four-function disk calculator (BASICA), regression program, PROFILE BASIC program optimizer, file compare.  
**#207.** PROKEY for LOTUS 1-2-3.  
**#208.** Racy pictures, FLASHDAN (music), MASTER-MIND, SMURF.  
**#209.** Games: nuclear attack simulation, robot arcade, miner-2049er-like game.  
**#210.** CASTLE (like Temple of Apsah).  
**#211.** Justification program, speed-reading demo.  
**#212.** PC-RBBS.  
**#213.** Adventure game creator, MUGGER adventure (good package).  
**#214-215.** Database package in BASIC (fairly extensive).  
**#216.** C programs: IBMTTY, calendar, screen control, etc.  
**#217.** Disk head alignment software, predator/prey simulation, super directory, screen dump.  
**#218.** Address manager.  
**#219.** MAPMAKER—mapping routines and files.  
**#220.** PROWRITER printer utilities.  
**#221.** NEC 8023A printer utilities.  
**#222.** TRANSTAR 315 printer utilities.  
**#223.** PASCAL .PAS and .ASM utilities.  
**#224.** PC-CALC 1.02 and utilities.  
**#225.** PC-FONT.  
**#226.** FREECOPY—present value concepts tutorial.  
**#227.** FINANCE (large program).  
**#228.** Games: PAC-GAL, FIREFIRE, MAZE, SLOT, VAMP, NUKIE (all in BASIC).  
**#229.** EUCHRE, FUNNELS.  
**#230.** The Confidant (version 2.0) encryption package.  
**#231.** REFLIST—a program to write and format reference lists for scientific and technical manuscripts. Includes many prototype files.  
**#232.** SPCC demo—correlation, multiple regression, statistics.  
**#233.** NEWBASE data base system.  
**#234.** TPNCalc—pharmacology system for calculating and handling data regarding solutions containing electrolytes, trace elements, proteins, etc.  
**#235.** Parts inventory control system.  
**#236.** Printer utilities to better use Toshiba printers with Volkswriter. BASIC program lister.  
**#237.** PC-General Ledger. Manual assumes working knowledge of accounting.  
**#238.** PC-TYPE—one line memory typewriter (even has umlauts). Seive benchmark. SPRITE—callable assembler routines for DOS functions not supported by BASIC.  
**#239.** IPCO graphing and math routines.  
**#240.** FT—ETC genealogy package.  
**#241.** PCjr educational games; includes graphics. Spelling and word games.  
**#242.** Sage Trade stock trader. Requires DOS 2.0.  
**#243.** Sage calendar and memo program, tag writer (written for a seed company).  
**#244.** Screen Write.  
**#245.** Ultra—utilities.  
**#246.** Stock charting system (documentation is a little skimpy).  
**#247.** BOBCAT small-business data base.  
**#248.** Complex math function library. Examples in Turbo PASCAL and FORTRAN.  
**#249.** EQUATOR—35 equation exercises from math, science, and finance. PC-TOUCH touch-typing tutor. Good disk.  
**#250.** CHECKBOOK, SYSMENU, printer control, and other utilities.

## PUBLIC DOMAIN - IBM PC-SIG

- #251. Time and Money financial recordkeeping system.
- #252. LISTMATE label making system.
- #253. Electronic 3 x 5 card indexing system. Nice package!
- #254. PC-DOS on-line help system.
- #255. Various BASIC and machine-language programs: MORSE, TIMER, SCREEN, LIST, Keyboard fix, SPEED, etc.
- #256. BIGCALC, many utilities.
- #257. ASCII text generator, printer controls, 1-2-3 PROKEY template.
- #258. Hex converter, SERIAL, TALK, diskette labeller, file searcher, CompuServe auto-logout, and many other utilities.
- #259. Complete "C" ADVENTURE, including "C" and object files. Great to play, or, for the programmer, to experiment with.
- #260. Games in BASIC: JETSET, SIMONSEZ, TRONLC, MORSE, SLOTMACH.
- #261. Personal datebook system, memo maker, label system.
- #262. PC-GOLF golfer data base, performance evaluation.
- #263-264. Laxon and Perry Forth: language and utilities.
- #265. Screen and Okidata graphics: Spirograph, function plot.
- #266. NAEPIRS (National Assessment of Educational Progress Information Retrieval System) data base and access programs to compare findings, etc.
- #267-268. Potomac Pacific Engineering Database/Spread sheet/Expert System of Steel disks #3 and #4. See earlier entries for #1 and #2. BAS source and compiled versions.
- #269. Beta Tool's BASIC Development System (demo version limited to 6500-byte program). Really nice! Variable dump, global search/change, etc. For IBM and COMPAQ.
- #270. Index for PC-SIG volumes 1-200.
- #271. Index for PC-SIG volumes 201-300 (when ready).
- #272. PC-SIG directory: sorted
- #273. Collection of the "best" utilities taken from previous volumes: RAMDISK, two-way scrolling, BROWSE, and much more.
- #274. Collection of the "best" games taken from previous volumes: XWING, BREAKOUT, PACKMAN, LANDER, WIZARD, CASTLE.
- #275. PC-CHECK checkbook, 1099 tax form generator, PC-PRINT print control (font) program.
- #276. COLLIST 2.0 file lister (for sending files to the printer).
- #277. FINDFILE to search for files, duplicates. Good for hard-disk systems.
- #278. QSYS 3.0 appointment calendar documentation (only). No program files.
- #279. PIANOMAN system for playing, recording, and editing music. Large package—looks good. Includes several examples.
- #280. Bibliographies for quite a few magazines through 10/84. Includes popular computer and ham radio magazines.
- #281. Recipe bibliography for 1800 recipes in 1983 Family Circle and Woman's Day magazines. Requires PC-FILE III (See IBM PC-SIG #5).
- #282. MERGEPLAN (Multiplan consolidator), checkbook management, stock value analyzer, home financial analyst.
- #283. UTILITIES #7: keyword search, program interrupt, RAM drive installer, directory toolkit, documentation file to BASIC program creator.
- #284. UTILITIES #8: Labelmaker, sector reader, auto-menu, programs for removing & adding line numbers to BASIC programs.
- #285. WHIZZARD screen I/O enhancer. Assembly language routines for accelerating the speed of screen output.
- #286. PC-VT video terminal emulator (to make IBM-PC with serial port behave like a DEC VT-100 or VT-102).

## PUBLIC DOMAIN - IBM PC-SIG

- #287. FILE EXPRESS (Volume 1 of 2). Information management system for small databases.
- #288. FILE EXPRESS (Volume 2 of 2).
- #289. POWER-WORKSHEETS. Lotus worksheets: NPV, BSTAT, linear regression.
- #290. TAX 84: Lotus tax worksheets for the various schedules. May be of help in 1985 taxes.
- #291. TAX 84: Multiplan version of #290 above.
- #292. SPACEWAR (good!), graphics and music demos, several games. A good collection.
- #293. Arcade games, including a 3-D Pacman, color breakout, several others. Requires color graphics card.
- #294. EDIT version 1.11. General purpose text editor. Limited to about 50,000 characters.
- #295. TAX-FILE. A very complete tax record system. Requires dBase II.
- #296. EAMON MASTER. A role-playing adventure converted from the popular Apple version.
- #297. EAMON DESIGNER and UTILITIES. See description under EAMON ADVENTURES elsewhere in this catalog (Adventure Games section).
- #298. PLANETS (Astronomy), LEYGREF'S CASTLE (Adventure), WATOR (Survival Game). Requires color graphics card.
- #299. Pert chart program, color graphics test patterns, megatrek.
- #300. Cub Scout record keeping system, household goods inventory. Both require dBase III.
- #301. Lotus worksheets, technical notes. Worksheets for financial analysis, photo fee estimation, etc.
- #302. Lotus worksheets: ACRS depreciation, auto expenses, biorhythm, golf handicapper, non-linear breaker, and much more. A good disk for Lotus users.
- #303. Lotus worksheets. Magee ledger—database, tax planning model.
- #304. Lotus worksheets: cash flow manager, loan amortization, payoff, EOQ inventory ordering, checkbook balancer, and more.
- #305. Symphony worksheets #1: appointment calendar, biorhythm, mailing list label printer, XMODEM, message retrieval, WordStar to Symphony, and more.
- #306. Symphony worksheet #2: ten-key calculator, checkbook manager, disk directory manager, macro conversion aid, phone dialer.
- #307. Hacker's disk: all sorts of stuff for the experienced programmer: 8087 error calls, cursor size, bugs, dynamic memory switch (MORERAM), read/write tests for drives, etc.
- #308. Assembly language programmer's collection. Lots of useful (as well as obscure) assembly language programs.
- #309. More along the lines of #308.
- #310. QMODEM communications. Written in Pascal. Includes autodial, character translation. Uses XMODEM protocol. A good disk!
- #311. Movie database: Includes nearly 2,000 movies with titles, ratings, major cast, writer, director. Can be searched by the above.
- #312. Screen Design Aid (SDA). Also generates forms for Epson MX-80.
- #313. Misc. business programs: PERT/PATH critical scheduling, depreciation, calendar, tax recording, computer usage record.
- #314. GREP for C86, Lattice C. Other C programs, Xenix.
- #315. Small C compiler (in C), C utilities, programs.
- #316. Communications utilities: filter, squeezer, bit stripper, hex converter, area code.
- #317. Database programs: calendars, index cards, mailing list, Rolodex.
- #318. dBASE2 programs: Label printing, mail, phone list, field changes, graphing, screens, field copying, color. A very good disk.
- #319. Disk utilities: make/access hidden directories, disk test, speed-up, sort, many more.
- #320. Touch Typing Tutorial.
- #321. Home applications: currency exchange, toll-free numbers, area code finder, checkbook, encryption, astronomy.
- #322. Music collection. Includes many songs.

## PUBLIC DOMAIN - IBM PC-SIG

- #323. Stock tracking and analysis through THE SOURCE.
- #324. Turbo-Pascal programs: Hi-res graphics, 3-D plot, text windows, games.
- #325. PC job logger (good for tax records).
- #326. Epson printer utilities: fonts, labels, PRTSC speed up, plot, chart, etc.
- #327. Trivia Machine, Volume 1 of 2 (requires both volumes): Large trivia game.
- #328. Trivia Machine, Volume 2 of 2.
- #329. Another trivia game, plus a few small games.
- #330. General ledger, check register, and two mail-list programs. Will run on PCjr.
- #331. PC-STOCK finance and PC-GL accounting programs.
- #332. Kinetics Linear Programming System, version 1.9. Decision tree and Multiattribute analysis.
- #333. FIDO bulletin board system, volume 1 of 2.
- #334. Volume 2 of FIDO, above.
- #335. Modifications for PC-TALK.
- #336. ABC Design character graphics color-image editor. Includes many files. Volume 1 of 2.
- #337. Volume 2 of ABC Design above.
- #338. SYSCOM communications package for unattended file transfer.
- #339. CREATOR, REPORTER, and CHEASORT database system.
- #340. INFOBASE forms-driven database system. Similar to Versa Form.
- #341. Games and utilities written in C.
- #342. Golf Scoreboard database.
- #343. Children's word processor: uses large characters, includes sample text.
- #344. PC-KEY-DRAW, Volume 1 of 2. Keyboard-to-screen drawing, graphics printing, slide show capability.
- #345. Volume 2 of PC-KEY-DRAW, above.
- #346. Color Paint; for medium-to-high resolution graphics. Includes fonts.
- #347. PC-FOIL. Combines words with simple diagrams.
- #348. LETUS A-B-C Volume 4. Continuation of database of letters and articles (1st quarter 1984). Byte, PC Age, PCjr, PC Magazine, etc.
- #349. Volume 5 of LETUS A-B-C, above; 2nd quarter, 1984.
- #350. Volume 6 of LETUS A-B-C, more 2nd quarter 1984.
- #351. Turbo Tools: Many Pascal utilities.
- #352. MVPFORTH, FORTH, and FORTH-H; both compiled code and assembly language (ASM).
- #353. Turbo Pascal programs: maze generator, animation, movies.
- #354. PCjr games (in BASIC): Dungeon Quest, Combat, Thermonuclear War.
- #355. PC-ZAP: DOS file modifier.
- #356. FANSI-CONSOLE: keyboard buffer, DEC VT100 emulator, etc.
- #357. GOLDWRITER demo; help screens, lesson screens.
- #358. BASIC cross-reference utility (a good program to have).
- #359. MOONBEAM: determines phase, position, and illumination of the moon. Star plotting.
- #360. PFROI stock portfolio demo disk.
- #361. Family History database system. Includes descendant reports, ancestor charts, etc.
- #362. SIMTERM: Creates IBM-PC simulation of HP-like terminal to Unix system.
- #363. PC-INPUT: Another screen generator.
- #364. Turbo Pascal Volume 3. Source code for "Software Tools in Pascal", chapters 1, 2, 4, 5, 8, and more.
- #365. Turbo Pascal Volume 4.
- #366. Turbo Pascal Volume 5.
- #367. Flash Cards: Vocabulary spelling tutor. Volume 1 of 4.
- #368. Volume 2 of No. 367 above.
- #369. Volume 3 of No. 367 above.
- #370. Volume 4 of No. 367 above.

## PUBLIC DOMAIN - IBM PC-BLUE

**PC-BLUE**  
**PUBLIC DOMAIN SOFTWARE**  
**FOR THE IBM PC**  
 (IBM only)

As with the PC-SIG library (described elsewhere), DYNACOMP is making available some very nice public-domain software at a price which basically just covers our costs.

You may either rent the entire collection for 10 days (\$99.95), purchase it (\$399.95), or purchase selected diskettes (\$5.95 each). The format used is single-sided MS DOS and PC DOS 1.0/2.0/3.0 one sided/two sided compatible. We have not included the entire collection because of overlaps with the PC-SIG library, and because some of the diskettes require an 8-bit 8080 microprocessor (it is not clear why they are in the library at all!)

If you choose to rent this library, the same restrictions apply as for renting the PC-SIG library; the late charge is \$10.00 per day. Individual diskettes cannot be rented and these diskettes do not count toward volume discounts.

Price: \$399.95 - Purchase of complete collection  
 \$ 99.95 - 10-day rental (plus \$10/day/late charge)  
 \$ 5.95 - per individual diskette

You will find these prices to be lower than those available elsewhere, and our speed of delivery is impressive.

**Mini-Menu** (Use the DYNACOMP diskette identification number shown at the left when ordering).

- PC-BLUE#1. Miscellaneous utilities: Super DIR, asynchronous communications, display utility.
- PC-BLUE#2-17 Not available. Require an 8080 or are duplicates of items in the PC-SIG library.
- PC-BLUE#18 PC-TALK (communications package), PAC-MAN2, PC notes.
- PC-BLUE#19 PC-FILE (database package)
- PC-BLUE#20 Remote bulletin board system, miscellaneous.
- PC-BLUE#21 Cross-reference utility, front-end interface utility (monitor).
- PC-BLUE#22 Expanding the lister utility for BASIC programs.
- PC-BLUE#23 RATBAS, warm system restarts, strip-off WordStar high bits, Graphtrax utility.
- PC-BLUE#24 BASIC games.
- PC-BLUE#25 BASIC games.
- PC-BLUE#26 8087 sampler programs.
- PC-BLUE#27-28 Kermit - PC/mainframe host communications programs by Columbia University.
- PC-BLUE#29 Miscellaneous BASIC programs.
- PC-BLUE#30 Misc. applications systems: cryptography, filing, inventory, mail list, regression.
- PC-BLUE#31 PC TALK III (supercedes PC TALK in Volume 18).
- PC-BLUE#32 PC-TALK III documentation, miscellaneous communications systems.
- PC-BLUE#33 Misc. applications: compression, music, dates, sunrise, plotting, etc.
- PC-BLUE#34 dBASE & SuperCalc templates.
- PC-BLUE#35 Miscellaneous BASIC utilities.
- PC-BLUE#36 IBM keyboard drill system.
- PC-BLUE#37 MODEM 7 for IBM PC, program control system, WordStar mods, misc. utilities.
- PC-BLUE#38 Disk directory utility, squish REMarks, Lotus 1-2-3 modifications.
- PC-BLUE#39 Screen editor, word processing, memo minder, history & multiplication drills.
- PC-BLUE#40 EPISTAT statistical package, IBM modem programs.
- PC-BLUE#41 Galaxy Trek with graphics (also works with monochrome monitor).
- PC-BLUE#42 A cheap assembler, electronic RAM disk, misc. utilities.
- PC-BLUE#43 Inventory order control system in dBASE II.
- PC-BLUE#44 PC graphics, by Eugene Ying.
- PC-BLUE#45 Bulletin board system.

PC-BLUE#46 Ringy Dingy asynchronous communications, PC-File III.  
 PC-BLUE#47 Software encipherment, quick graphics, spooler, sort demo, caps/num lock control.  
 PC-BLUE#48 Portfolio valuation, print spooler, hi-res screen print, draw.  
 PC-BLUE#49 Remote bulletin board system (RBBS).  
 PC-BLUE#50 FreeCalc spreadsheet.  
 PC-BLUE#51 Lotus 1-2-3 tax template (1983). Could be used as a starter for new template.  
 PC-BLUE#52 Misc. utilities: key re-definition, bricks (arcade), big print, diskette cleaning, etc. Large collection.  
 PC-BLUE#53 PC-Dial communications, PC-Write word processor.  
 PC-BLUE#54-55 FIG Forth.  
 PC-BLUE#56 Lotus 1-2-3 utilities.  
 PC-BLUE#57 DU ultra utilities, LU update, squeeze-unsqueeze.  
 PC-BLUE#58 Genealogical programs in BASIC.  
 PC-BLUE#59 EPISTAT statistical package.  
 PC-BLUE#60 Ten Key, Media Magician (limited versions), PC Musician.  
 PC-BLUE#61 Misc. BASIC games: Bomb, ask, grump, rubic, solitaire, BASXREF, MAP, QSORT.  
 PC-BLUE#62 Misc. utilities and information. Well worth getting.  
 PC-BLUE#63 Programmer's Calculator, touch typing practice, Lotus templates.  
 PC-BLUE#64 Home finance, full screen editor, BASIC program optimizer.  
 PC-BLUE#65 Micro accounting system (in BASIC), mail list system, tax planner.  
 PC-BLUE#66 Misc. utilities: directory print, banners. Donkey Kong-like program.  
 PC-BLUE#67 File manager (updated from #30), general ledger.  
 PC-BLUE#68 8086/8087/8080 disassembler, compile and link generator, utilities, DOS menu master.  
 PC-BLUE#69 Virtual Teaching Language Interpreter.  
 PC-BLUE#70 Disk catalog system.  
 PC-BLUE#71 Encipherment system, version 1.53, PC-DOS version.  
 PC-BLUE#72 #71, but for MS DOS.  
 PC-BLUE#73 Sixty-eight files, mostly notes. A lot of miscellaneous information.  
 PC-BLUE#74 RBBS, PC version 12.2B.  
 PC-BLUE#75 SIG/M Property Manager. Requires dBaseII v. 2.4.  
 PC-BLUE#76 Updated MODEM programs: XMODEM with FORTRAN source, KERMIT.  
 PC-BLUE#77-78 FIDO-Net bulletin board system, v.9; hard disk.  
 PC-BLUE#79 RBBS, PC version 12.2C.  
 PC-BLUE#80 Experimental LISP (XLISP), FOG Finder v. 1.2.  
 PC-BLUE#81 Miscellaneous utilities and utility updates. Poor man's mouse, EBASIC XREF, "C" lister, equipment status, bidirectional scroll; an interesting collection.  
 PC-BLUE#82 8086 Forth v. 2.10.  
 PC-BLUE#83 Finance Manager v. 3.0, personal date-book.  
 PC-BLUE#84 LOTUS Power Worksheets.  
 PC-BLUE#85 GLUDRAW line graphics system with many help and picture files.  
 PC-BLUE#86 MS DOS ROFF text editor v. 1.60, Extended BATCH language v. 2.0.  
 PC-BLUE#87 List-Mate mail merge for Multi-Mate, PC-Check check balancer (in BASIC).  
 PC-BLUE#88 Family Tree (FT-ETC), Letters 'N' Labels, banner generator.  
 PC-BLUE#89 Global pathing utility, Toshiba printer driver for Volkswriter.  
 PC-BLUE#90-92 Multi-user Super Trek. Requires 8087.  
 PC-BLUE#93 IBM PC User Group Newsletter, miscellaneous information files.  
 PC-BLUE#94 Compact XMODEM, dBaseII mail list, PC Programmer's calculator, system clock reminder.

PC-BLUE#95 Word processor for kids, checkbook/ledger, file listing program.  
 PC-BLUE#96-97 FIDO Bulletin Board System, v. 10.  
 PC-BLUE#98-99 ABBS version 12.2D.  
 PC-BLUE#100 U.S. Census Utility; County and City Datebook.  
 PC-BLUE #101 Volume 2 of U.S. Census utility.  
 PC-BLUE #102 Games: Castle Adventure, Janitor Joe, 3D Demon Chase (all in machine language).  
 PC-BLUE #103 Pascal games (BACCRAAT, DODGE, HANGMAN, 20 more), 3-D graphics generator with examples.  
 PC-BLUE #104 Miscellaneous utilities: Hex converter, incremental backup, printer to disk, WordStar customization.  
 PC-BLUE #105 Miscellaneous Utilities: UNIX terminal emulator, protect/unprotect, PC-SWEEP disk utility.  
 PC-BLUE #106 PC-TALK for PCjr, IBMODEM for PCjr.  
 PC-BLUE #107 KERMIT 2.26, QMODEM 2.87E.  
 PC-BLUE #108 Extended disk directory, dBASE phone utility, Time Keeper, Extended Batch Language.  
 PC-BLUE #109 Multi-user RBBS-PC 12.3b, vol 1.  
 PC-BLUE #110 Volume 2 of #109 above.  
 PC-BLUE #111 Misc. utilities: Epsom/Gemini conversion, ASCII-LOTUS, encryption, Hebrew graphics, Epson options.  
 PC-BLUE #112 Area code finder, sorted directories, global time stamp, calendar generator.  
 PC-BLUE #113 Time and Money: A simple financial monitoring system.  
 PC-BLUE #114 PC-TALK III (assembler-version), QModem 103A, Daily Diary.  
 PC-BLUE #115 ScreenWrite formatter, PC Calculator.  
 PC-BLUE #116 Genealogy, church management, checkbook (dBASE programs).  
 PC-BLUE #117 Genealogy On Display by M.D. Duke (in BASIC).  
 PC-BLUE #118 PC-Talk V2.1, Host-III, QModem V104, QMODEM background dialer.  
 PC-BLUE #119 Kermit 2.27, NewKey 2.13.  
 PC-BLUE #120 Investment record system, check reconciliation, new fonts, menu generator.  
 PC-BLUE #121 Bidirectional scrolling, jacket label printer, directory sort/list, tax log, general ledger.  
 PC-BLUE #122 Medical/banking worksheets (for Symphony).  
 PC-BLUE #123 Lotus graphics printer, Symphony insurance worksheets.  
 PC-BLUE #124 Lotus 1-2-3 worksheets, macro conversion aid.  
 PC-BLUE #125 3 x 5 Information Management v.1.0.  
 PC-BLUE #126 File Express information management system, volume 1.  
 PC-BLUE #127 Volume 2 of #126, above.  
 PC-BLUE #128 Prolog artificial intelligence, Spacewar, Bluesox music generator.  
 PC-BLUE #129 XLISP version 1.4.  
 PC-BLUE #130 PC-Write version 2.4.  
 PC-BLUE #131 PC-DBMS version 1.0.

### WHEN ORDERING PUBLIC DOMAIN DISKS ...

Please do not make the following mistake. If you see a public domain listing such as "171-174 Supersomething Software Library", this is not one volume. The listing refers to four volumes (171, 172, 173, and 174) of software. If the price is \$3.95 per volume, the price for our example (171-174) is four times \$3.95 plus shipping and handling.

### PC-GREEN PUBLIC DOMAIN SOFTWARE FOR THE IBM PC (IBM only)

Here is yet more very nice public-domain software at a price which basically just covers our costs.

You may either rent the entire 42 volume collection for 10 days (\$49.95), purchase it (\$159.95), or purchase selected volumes (\$5.95 each). The format used is PC DOS and MS DOS compatible.

If you choose to rent the library, the same restrictions apply as for renting the PC-SIG library, except that the late charge is \$6.00 per day. Individual volumes cannot be rented, and these volumes do not count toward quantity discounts.

Price: \$159.95 - Purchase of 42-volume collection  
 \$ 39.95 - 10-day rental (plus \$6/day late charge)  
 \$ 5.95 - per individual volume

You will find these prices to be lower than those available elsewhere, and our speed of delivery is impressive.

**Mini-Menu** (Use the DYNACOMP volume number, shown at the left of each title, when ordering.)

PC-GREEN #1 Utilities: Append ASCII files, BASIC XREF, disassembler, .COM to .BAS conversion for transfer, DOS 2.0 ZAP, directory sort, .COM to .HEX, and many more. Looks good!

PC-GREEN #2 Non-graphics games: tic-tac-toe, cribbage, etc.

PC-GREEN #3 More non-graphics games: biorhythm, darts, pong, football, nim, lunar lander, ski slalom, etc.  
 PC-GREEN #4 Graphics games: Artillery dual, Rubic's cube, lunar lander, 3-D Tic-Tac-Toe, UFO.

PC-GREEN #5 DIMS database management and others. Word processing.

PC-GREEN #6. Communications: PC-TALK, PC-SPEAK, HOST2, TCOMM.

PC-GREEN #7 Music programs: several songs, program to help you write music routines.

PC-GREEN #8 Graphics demos: 3-D PLOT, BIGTYPE, COLOR. Plus many sound demos (in BASIC), sorting routines.

PC-GREEN #9 Miscellaneous: Series of programs to teach BASIC, bar chart generator, FORTH, Morse code, loans and interest, star maps.

PC-GREEN #10 DESK MASTER secretarial programs, FRED text editor, PC-FILE 8.2.

PC-GREEN #11 Communications: PC-TALK3.

PC-GREEN #12 EPSLST text printer, PC-WRITE word processor.

PC-GREEN #13 BASORT, fully documented machine-language sorting program (DOC, ASM files, etc.); disk utilities; RAM DISK; XREF.

PC-GREEN #14 Non-graphics games: BALL, CASTLE, OTHELLO, TANK, more.

PC-GREEN #15 Utilities: Extended batch system, hidden file creator, GRAFTRAX, spooler, much more.

PC-GREEN #16 MAIL I mailing list, PC-LABEL

PC-GREEN #17 Statistical programs: BAYES, BINOMIAL, FISHERS, CHISQR, MCNEMAR, RANKTEST, etc.

PC-GREEN #18 DESKTOP data management system, Volume 1 of 2.

PC-GREEN #19 Volume 2 of #18, above.

PC-GREEN #20 Communications: 1-Ringy Dingy by Jim Button, XMODEM.

PC-GREEN #21 DOWDIF (converts Dow-Jones to DIF files), Picture Graphics System (plus 10 demos).

PC-GREEN #22 FreeCalc spreadsheet system.

PC-GREEN #23 Utilities: Disassembler, spooler, various others.

PC-GREEN #24 Mini-assembler, machine code to BASIC data-statement converter (very useful!), PDRAW "Etch-A-Sketch".

PC-GREEN #25 LADYBUG implementation of LOGO Turtle Graphics, with many files.

PC-GREEN #26 Genealogy, version 3.0.  
 PC-GREEN #27 Utilities: Disk test, scrolling, .COM to .BAS conversion for transmission.  
 PC-GREEN #28 Batch File Utility. Complete system.  
 PC-GREEN #29 Edit Text text editor.  
 PC-GREEN #30 LOTUS 1-2-3 Tutorial, version 1A.  
 PC-GREEN #31 LETUS A-B-C Magazine Reference, Volume 1. Requires PC-FILE or FILE EXPRESS to read.  
 PC-GREEN #32 Volume 2 of #31, above.  
 PC-GREEN #33 Volume 3 of #31, above.  
 PC-GREEN #34 STARFIND star and constellation display program (BASIC and compiled).  
 PC-GREEN #35 LETUS A-B-C Volume 4 of #31, above.  
 PC-GREEN #36 FILE EXPRESS data management/word processing, Volume 1 of 2 volumes.  
 PC-GREEN #37 Volume 2 of #36, above.  
 PC-GREEN #38 PC-FILE III. This is not a public domain program. If you keep and use the package, you are supposed to send the author \$49.  
 PC-GREEN #39 TIME & MONEY financial management system.  
 PC-GREEN #40 FREECOPY disk copying utility.  
 PC-GREEN #41 LOTUS 1-2-3 Worksheets.  
 PC-GREEN #42 Graphics games: SPACE WAR, JUMP JOE.

### APPLE PASCAL PUBLIC DOMAIN SOFTWARE (Apple only)

If you have an Apple computer and are "into" PASCAL, here is a collection of software which you should seriously consider. You will probably want to get the entire set. Remember, however, that this is public-domain software, and may have bugs (in PASCAL programs! Heaven forbid!!); see the disclaimer under the APPLE PUBLIC DOMAIN SOFTWARE listing.

Price: \$ 3.95 each (1-4 diskettes)  
 \$ 3.45 each (5-10 diskettes)  
 \$ 2.95 each (11+ diskettes)

Note: These diskettes cannot be used in or applied toward DYNACOMP's 10%-20% quantity discount.

When ordering, please CLEARLY state the DYNACOMP volume number (e.g., APLPAS #3).

APLPAS #1 TITLE, COMBINE, CHASE, LIST, TYPESET, INTRINSIC

APLPAS #2 PILOT, PRETTY, BLACKJACK, FORMAT, STARS

APLPAS #3 DRAWLINE, MOTGEN, MUD, SIEVE, FILEIO, LCM, GCD, SORT, PLOT

APLPAS #4 KINETICART, PASCALZAP, PRINTNET, SAILCALC, CENTRON737

APLPAS #5 INTKORR, MONITOR, CROSSREF, SORTDEMO, LINEFEED, SYNTAX, HANOI, PI

APLPAS #6 ATTACHUD, ADMERG, LIST, FORTFIX

APLPAS #7 PROSE, ANSWER (MODEM program)

APLPAS #8 CLOCK, TRANSFER, DISASM, LCASE, BIOS, COPY, STARTUP

APLPAS #9 .TEXT files for APLPAS #8, STRINGS, ROBOTS

APLPAS #10 CLOCK, PLOTTER, SYSGEN, NATIVE-CODE, DOSCAT, DISKDUMP, DIRECTORY, FULL-DUPLEX, CHAREDDIT

APLPAS #11 DIABLO, PLOTTEST, MINIPUB, LANDER, DCCONTROL, FLASHDEMO

APLPAS #12 Payroll and Ledger programs

APLPAS #13 CHESS, OTHELLO, TURTLE, CHECKERS, PATCHER, PARSER, TERM, BAMBI

APLPAS #14 PASCAL examples

APLPAS #15 GETTIME, CASH REGISTER, MCRMODEM, DEBTS, GENEPOOL

## APPLE PUBLIC DOMAIN SOFTWARE

(Apple only)

The DYNACOMP quest for public domain software continues! This time we've uncovered a library of 121 diskettes. From these we selected 50 for inclusion in the DYNACOMP catalog. These diskettes are super bargains for the price. A word of caution, however: these programs are not supported, and are not necessarily of commercial quality. If a diskette has a read error, we will replace it free of charge. Otherwise, no returns. We simply can't afford to support this software at the price we charge (basically a small copying fee plus the cost of the diskette). Also, no other discounts apply other than those given below. All diskettes are copied on one side only, but there is a lot on that side!

Price: \$ 3.95 each (1-4 diskettes)  
3.45 each (5-10 diskettes)  
2.95 each (11-50 diskettes)  
139.95 for the complete set

When ordering, please CLEARLY state the DYNACOMP volume number (e.g., APD #3).

- APD # 1 Graphics demos
- APD # 2 3-D graphics demos
- APD # 3 Character table generator, tables
- APD # 4 Contour graphics demos
- APD # 5 Shape editor, graphics
- APD # 6 Graphics demos
- APD # 7 Table maker, graphics
- APD # 8 Graphics generator
- APD # 9 More graphics demos!
- APD #10 Astronomy; OSCAR/planet locator
- APD #11 Satellite tracking
- APD #12 Aircraft database
- APD #13 More aircraft data
- APD #14 Stock monitor, VISICALC formulas
- APD #15 Inventory, depreciation, financial
- APD #16 Amortization, NPV, filing
- APD #17 Checkbook, budget
- APD #18 Database management
- APD #19 Beagle Bros. demo
- APD #20 School grading programs
- APD #21 Chemistry grader
- APD #22 Modem programs
- APD #23 Ham log
- APD #24 Antenna height, plot, filters
- APD #25 Calorie counting, recipes
- APD #26 Games
- APD #27 Games
- APD #28 Games
- APD #29 Games
- APD #30 Games
- APD #31 Games
- APD #32 Games
- APD #33 Games
- APD #34 Adventure
- APD #35 Hello/menu programs
- APD #36 Math and statistics
- APD #37 Statistics, calculus
- APD #38 Functions, plotting
- APD #39 Miscellaneous
- APD #40 Miscellaneous
- APD #41 DOS/BASIC utilities
- APD #42 Renumber, sort, utilities
- APD #43 Sorting
- APD #44 Utilities
- APD #45 Utilities
- APD #46 Epson utilities
- APD #47 Epson utilities, games
- APD #48 Slide show
- APD #49 Disk catalog
- APD #50 Micro Lisp, airfoil designer

## APPLE PUBLIC DOMAIN COLLECTION #2

(Apple only)

Here we go again! Another super collection of Apple public domain software, and at prices not much more than the cost of the diskettes themselves. However, remember our usual warning (see the discussion under the APPLE PUBLIC DOMAIN SOFTWARE listing): this software is a tremendous value for the price, but expect some of the programs to have "bugs", and don't expect "commercial" quality.

Price: \$ 3.95 each (1-4 diskettes)  
\$ 3.45 each (5-10 diskettes)  
\$ 2.95 each (11+ diskettes)  
\$249.95 for the complete set

Note: These diskettes cannot be used in or toward DYNACOMP's 10% - 20% quantity discounts.

When ordering, please CLEARLY state the DYNACOMP volume number (e.g., APLPD#3).

Below you will find an abbreviated and annotated listing of the programs on these disks. Some are in (A)pplesoft BASIC, some are in (I)nteger BASIC, and some are (B)inary load files. Most of these diskettes are full and we have generally indicated only the largest programs.

- APLPD#1 AMPER SORT (B), APPLE CAPTURE (A), HIRE DUMP (B), APPLE TYPER (I), SPACE TRIP (I), ASSEMBLER (A), INTBASIC (I), DISK SORT (A)
- APLPD#2 BIORHYTHM (A), MASTERMIND (A), QUARRY (A), TARGET SHOOT (II), BACH (A), SKIER (A), ALIEN HEART (A), APPLESOFT SHAPEMAKER (A)
- APLPD#3 APPLSTAR 1990 (A), QUEST (A), DOUBLE DOS (B), CALENDAR (A), REMINDER GENERATOR (A), BATNUM (A), HOOVER DAM (I), STOCK TRADER (A)
- APLPD#4 MADLIB (I), RUBIK (A), MORSE CODE (I), PERPETUAL CALENDAR (A), MICROMODEM FLIGS (A)
- APLPD#5 CALCULATOR (A), AWARI (I), TEXT EDITOR (A), OHELLO (I), SCREEN PRINT (B), HANOI (I)
- APLPD#6 MATH DRILL (A), SHAPE COMPILER (A), OPTION WRITER (A), CREW (A), SHAPE MOVER (A), ALGEBRA (A), DISK MODIFIER (A), STATIC ELECTRICITY (A)
- APLPD#7 GRAPHING (A), SPELUNKER (A), SOUND (B), CATALOG (A), SOLAR SYSTEM (A), PICTURE (B), SNAKE (B), SPACE MUSIC (A), music files.
- APLPD#8 POKE 33 (A,B), RAM TEST (A), SECTOR LIST (A), LOANS (A), TRACK 35 (B), CALORIE COST (A)
- APLPD#9 CANYON RUN (A), DISKSCAN (B), FASTBOOT (A), MORSE CODE (B), ERROR HANDLER (A), LAPLACE INVERSION (A), NEW COPY (A), DEMUFFIN (B), CALORIE COUNTING (A), DIET PLANNER (A)
- APLPD#10 Bulletin Board System (BBS).
- APLPD#11 SYSOP(BBS) instructions.
- APLPD#12 DOTS (A), BASICALC (B), HOME MORTGAGE (A), MAZE (A), PAYROLL (A), STAT ANALYSIS (A)
- APLPD#13 SPELLER (I), DISASSEMBLER (B), SWEET16 (B), MINIASSEMBLER (B), HANGMAN (I), PIG LATIN (A)
- APLPD#14 VOICE PRINT (A), ASCII (I), SLANT (B), DRILL (B), DNA (A), BUG (B), XZONE (B)
- APLPD#15 COLOR BARS (A), MAIL LABELS (A), MOVE SCREEN (A), PARABOLIC CALCULATIONS (A), POKER DICE (A), BIORHYTHM (A), MICROSCOPE (A), FAMOUS SAYINGS (A)
- APLPD#16 LATTADATA GRID (A), DISKDUMP (I), ARRAYS (A), COMPARE (A), TEST WRITER (A), JUPITER (A), LIFE (A), LISAFIND (B)
- APLPD#17 SUPERBLAST (B), THE MAXX MACHINE (B), FLIP IT (B), MAXX'S MADNESS (B)
- APLPD#18 RAID (B), WORLD WAR (A), SLOT MACHINE (I), COLT RACE (A), FOLLOW ME (I)
- APLPD#19 ED'S PLOT PACKAGE (text file also on #18)
- APLPD#20 SOFTWARES (A), AUCTION (A), THESAUR-

- IAN INDEX (A), SUPER DRAW (A), WORD CHALLENGE (A), HEADER (A), SQUAD LEADER (A)
- APLPD#21 DISK SORT (A), MALARIA (A), DISK CHECK (B), DISKCAT (A), NAME THE STATES (A), SUPER LABEL (A)
- APLPD#22 PRESCHOOL FUNPACK (A), CODE PRACTICE (A), RUBIK'S CUBE (A), EPSON SETUP (A), DISKSCAN (B)
- APLPD#23 3D CUBES (A), STATES AND CAPITALS (A), NATIONS AND CAPITALS (A), DEMUFFIN PLUS (B)
- APLPD#24 BEE CRUNCH (B), BEACH HEAD (B), WESTWARD HO! (B)
- APLPD#25 Statistics, business.
- APLPD#26 MASTER CATALOG (A), HANOI (A), CRAZY STORIES (A), FINANCIAL WIZARD (A), WORD POWER (A)
- APLPD#27 MAIL LABEL (A), CREDIT CARD (A), picture and graphics programs.
- APLPD#28 DATA EDITOR (A), PHOTON CYCLES (I), TRADER (A), PIE CHART (A), COLOR MATH (I), ASTRONOMY (I), SURVIVAL (A)
- APLPD#29 KONG (A), DISK VERIFY (A), WEIRD NOISES (A), PROGRAM LISTER WRITER (A), MUSICIAN (A), DOUGS PINBALL (B)
- APLPD#30 CAMEL (A), TRADE STUDY (A), CLOUZOT (A), MUSIC MACHINE (A), DANGER (A), PLOTTER (A)
- APLPD#31 NUMBER PAD (A), PRINT ROUTINES (A), EPSON LABEL MAKER (A), SILVER VALUE OF COINS (A), CALC-MAN (A)
- APLPD#32 FINANCIAL EVALUATION (A), PRESSURE CURVES (A), MOTION SIMULATION (A), DOM INDEX (A)
- APLPD#33 MUSIC GENERATOR (I), MATH DRILL (A), MINUTE WALTZ (I), HARMONIC MOTIONS (A), DOS MOVE (B), ANIMATIONS (I), FREUD (A)
- APLPD#34 RING QUEST (A), PARAMETRIC PLOTTER (A), QUADRATIC SURFACES (A), NEWTON ROOT (A), MONEY MARKET (A), TEST MAKER (A)
- APLPD#35 CLASSFILE (B), CRYPTOGRAM (I), ATTENDANCE (A), STUDENT FILES (A), EQUATIONS (I)
- APLPD#36 COPYCAT (I), DIET AID (A), MIDPOINT (A), X-Y GRAPHER (A), PERIMETER DRILL (A), HUMAN PHYS (A), FOOTBALL STATUS (I), PLOTTING (I)
- APLPD#37 VOLLEYBALL (A), RECIPE FILE (A) plus files, BIBLIOMAKER (A), ART DAZZLER (A), BOOK INVENTORY (A), OPENESS TEST (A), MUSIC INDEXER (A)
- APLPD#38 RPN CALCULATOR (A), GREAT CIRCLE ROUTE (A), APPLE LANES (B), AIRPLANE DOG FIGHT (I), CONIC (A), UNDELETE (A), MODEMX (B)
- APLPD#39 MINI-ELIZA (A), ECOLOGY (A), REACTOR (A), ASSERTIVENESS TRAINING (A), FORECAST (A), MINING SIMULATION (A), GAUSSIAN QUADRATURE (A)
- APLPD#40 ROAD TRIP (A), POWER START (A), MOONBASE (A)
- APLPD#41 SULLIVAN READER (A) plus text files.
- APLPD#42 DISK MAP (B), NIFFUM (B), WORD PROCESSOR (A), several nice disk utilities.
- APLPD#43 QUIZ (I) on presidents, capitals, Canada, etc.
- APLPD#44 Many math programs, elementary through high school.
- APLPD#45 More math like APLPD#44.
- APLPD#46 AIRPORT (I), MICROTTEXT (A), SUPER MATH (I), GRAPHS (A), INCOME ESTIMATION (A), several math programs.
- APLPD#47 STAR LOCATOR (A), and PLANET LOCATOR (A), plus numerous data files.
- APLPD#48 SHOWER (A) plus manyimage files (tiger, plane, etc.)
- APLPD#49 SPITZ (A), SKYWRITER (A), PADDLE GRAPHICS (A), SHAPER (A), FAA TEST (A), GRAPHIC DEMO (A)
- APLPD#50 FRENCH HANGMAN (I), VECTOR (A), GRAPHING (A), DRIVING TEST (I), OHM'S LAW (A)
- APLPD#51 KINEMATICS (A), CHEM DENSITY (A), RADIO (B), TITRATION (A), EQUATIONS (A), PLANCK (A), MOLAR (A), and similar programs.
- APLPD#52 ENERGY (A), MOMENTUM (A), STATISTICS

- (A), CHARGE (A), DYNAMICS (A), PROJECTILE (A), and similar programs.
- APLPD#53 AIRFOIL (A), ENGINE (I), several education programs, miscellaneous.
- APLPD#54 Over 60 miscellaneous programs: SWEET16 (I) disassembler, MENU WRITER (A), LOCK DISK (I), FORMAT (A), HEAPSORT (A), TEXT FILER (I), PRINTER DRIVER (B)
- APLPD#55 Many math programs: TRAPAZOIDAL RULE (A), AREA UNDER CURVE (A), ROOTS (A), PRIME FINDER (A), etc.
- APLPD#56 Music programs.
- APLPD#57 HAMMURABI (I), STARWARS (A), ANIMATIONS (I), CHESS (I), HYDROCARBONS (I), BATTLESHIP (I)
- APLPD#58 PIZZA (A), CAMERA DEMO (A), GENETICS (A), BIG DIPPER (A), graphics displays (Canada, grasshopper, etc.)
- APLPD#59 INVENTORY (A), HYPERBALL (A), DRILL (I), BALLISTICS (A), ART FLIP (B), FRED FRACTION (I)
- APLPD#60 SPEED READING (A) plus data files, VIZISORT (A), MATHDUNGEON (A)
- APLPD#61 PLOTTING (I), CAL. DRIVING TEST (I), BAGELS (A), MATH QUIZ (A), MORTGAGE (A), other math programs
- APLPD#62 SINE WAVES (A), EQUATIONS (I), MULTIPLICATION BINGO (A), LAF ISLAND (A), GEOGRAPHY (A), DYNAMATH (I), FORECAST (A)
- APLPD#63 VOWEL SEARCH (A), ALPHABETICS (A), FOOTBALL (A), LOGIC PRACTICE (A), SOLVING/GRAPHING (A)
- APLPD#64 JIG-SAW (I), JOTTO (A), BATNUM (A), WUMPUSS (A), MINDWARD (I), GIANT TYPEWRITER (I), YAHTZEE (I)
- APLPD#65 PLANET OF THE ROBOTS (A), SIMPLE SIMON (A), MUSIC (A), SLIDE SHOW (A) plus pictures.
- APLPD#66 Text files on various subjects.
- APLPD#67 TOM'S MATH DRILL (A), WRITE A SONG (I) plus many music files, RUTHER (A), IOWA (A), ALGEBRA (A)
- APLPD#68 SLOPES (A), CHARGE (A), CHEMIST (A), DICE (A), DISTANCE (A), BRAZE-HUNTINGTON SIMULATION (A)
- APLPD#69 MODEL ROCKETRY (A), RADIO (A), LINEAR PROGRAMMER (A), FINANCIAL PAK (A), XMAS CARD (A), HIGHER TEXT (B)
- APLPD#70 PORTFOLIO REVIEW (A), OPTION PRICING (A), STOCK OPTIONS (A), AUTO PURCHASE (A), SECURITY ANALYSIS (A), plus similar programs.
- APLPD#71 WARLORDS (I), CYLON (I), SKUNK (I), DECISION MAKER (A), MACHINE LANGUAGE TUTOR (I), INVADERS (A), METEOR BLUR (I), INVESTMENT (A), GOLF (A), DATABASE (A)
- APLPD#72 SHARK (A), FILE CABINET (A), MATH DEATHLON (A), SUPERZAP (I), MINER (A), GALAXIA (A), MINI-GOLF (A)
- APLPD#73 SPELLING BEE (A) plus spelling files, DEFENSE (A), RECIPE FILE plus recipe files, DISK COMMAND EDITOR (A)
- APLPD#74 Integer BASIC music programs (very interesting)
- APLPD#75 EPSON printer programs; a must if you have an EPSON printer.
- APLPD#76 File Transfer Program (FTP) system
- APLPD#77 DISPLAYER (A), and many picture files.
- APLPD#78 DIVERSI DIAL (B)
- APLPD#79 CAT MODEM programs.
- APLPD#80 Ham radio programs: LOG (A), BRIDGE (A), TRUTH TABLES (A), etc.
- APLPD#81-83 Agriculture programs: TANK (A), SPRAYER RATE (A), CROP SELECT (A), FOOD COSTS (A), etc.
- APLPD#84-89 Religion program and data file collection. Reference, concordance, traits, personalities, maps, hymns, calendars, quizzes, study quotations, etc. We have never seen such a complete assemblage of religion-oriented software.
- APLPD#90 Diversi copy: DCOPI (B), DOG FIGHT (B)



### APPLE CP/M PUBLIC DOMAIN SOFTWARE

(Apple only)

This is a small collection of public domain software specifically meant for the Apple CP/M environment. Each disk is nearly full of programs and documentation. However, the same disclaimer applies as for the APPLE PUBLIC DOMAIN SOFTWARE collection (listed elsewhere).

Price: \$ 3.95 each (1-4 diskettes)  
\$ 3.45 each (5-7 diskettes)  
\$24.95 for the complete set

### CP/M PICONET PUBLIC DOMAIN

(CP/M only)

PICONET is another nice collection of software for the CP/M environment. For details regarding requirements, comments, warranty, and discount limitations, see the discussion under the CP/M UG PUBLIC DOMAIN title. The price schedule is shown below:

FORMAT*	PURCHASE		RENTAL*	
	1-9 Volumes per volume	10-19 Volumes per volume	20+ Volumes per volume	Complete Set
8-inch IBM 3740	\$8.95	\$7.95	\$6.95	\$169.95
DYNACOMP STANDARD FORMAT DSDD	\$8.95	7.95	6.95	\$169.95
DYNACOMP SPECIAL FORMAT DSDD	\$11.95	\$9.95	\$8.95	\$219.95
DYNACOMP STANDARD FORMAT SSDD	\$9.95	\$8.95	\$7.95	\$199.95
DYNACOMP SPECIAL FORMAT SSDD	\$13.95	\$11.95	\$10.95	\$239.95
DYNACOMP STANDARD FORMAT SSSD	\$14.95	\$12.95	\$11.95	\$289.95
DYNACOMP SPECIAL FORMAT SSSD	\$17.95	\$15.95	\$13.95	\$339.95
APPLE CP/M	\$9.95	\$8.95	\$7.95	\$199.95

\* See CP/M UG PUBLIC DOMAIN

Remember to clearly specify your machine make and model, disk format, and the disk stock number (e.g., PICONET #23).

PICONET #1. CRC test, FINDBAD, LU library utility, RBBS list, squeezer, UNERA, extended directory display.

PICONET #2. MBASIC games: MAZE, LOVE, MERABBIT, ORBIT, PINBALL, QUBIT, QUEEN, REVERSE, SLALOM, and many more.

PICONET #3. CBASIC financial package, MBASIC games: biorhythm, BOGGLE, TOWERS, TRAP, and many more.

PICONET #4. MORE MBASIC games: BLACKBOX, BOMBURUN, CAMEL CHASE, CLUE, CONVOY, and many more.

PICONET #5. AND EVEN MORE MBASIC games: DEEP-SPACE, GEOWAR, GRANPRIX, DRAGRACE, JOUST, KING, and many more.

PICONET #6. DIMS database management system in MBASIC.

PICONET #7. SMALL C in BDS C: miscellaneous programs.

PICONET #8. CROSS assemblers in BDS C: 1802, 6800, 1802 development module, absolute disk copy.

PICONET #9. YAM MODEM system, UNICORN BDS C LINKER.

PICONET #10. SIL 8080/Z80 utilities, Apple MODEM, memory test, Micro Tel-Net (MTN), others.

PICONET #11. MicroNet BIOS for CP/M, debugger, FIND, 8080 FIG Forth, PASSWORD, file manager, MBASIC unprotect, UNERA.

PICONET #12. BBS utilities; MODEM setup for Altos, Horizon, Osborne, Superbrain, MODEM, MODEM7

Note: These diskettes cannot be used in or applied toward DYNACOMP's 10%-20% quantity discount.

When ordering, please CLEARLY state the DYNACOMP volume number (e.g., APLCPM #3).

Sample directories (abridged, DOC files not shown):

APLCPM #1 DU-V75, MODEM, RESOURCE

APLCPM #2 MBASIC games: LIFE, MASTERMIND, ORBIT, SALVO, TOWERS, TARGET, RUSSIAN ROULETTE, MUGWUMP

APLCPM #3 APMOVE, ERASE, UNERASE, STATUS, XMODEM, TPA, MX80 PLOT

APLCPM #4 .MON files: ALLENTOWN, COMPUSER, CPM-NET, HYDEPARK, MISAMENU, PALATINE

APLCPM #5 APXMODEM, CRC CHECK, utilities

APLCPM #6 SQUEEZE/UNSQUEEZE, HELP, HIMEM

APLCPM #7 Index, catalog programs, I/O patches, APMODEM, APXMODEM, MLIST50

APLCPM #8 PIP PATCH, APSTARTUP, PROTECT, RCPM DISK, UNERA (Compressed ASM files)

PICONET #13. MODEM76, BYE79, MODEM programs. Super SUBMIT, bad sector lockout.

PICONET #14. Utilities and ZCPR. 8080 extended CP/M 2.2.

PICONET #15. CP/M Users Group catalog

PICONET #16. PICONET newsletters.

PICONET #17. Utilities: Compare, disk labeling, diskette catalog maintenance, file protect.

PICONET #18. Utilities: super directory, text cleaner, directory programs.

PICONET #19. SIL (Systems Implementation Language) to generate code for 8080/Z80/8085, 6502, 6800/6801. A "higher level" assembler with lots of support files.

PICONET #20. MODEM782, SQUEEZER, BBS list.

PICONET #21. Small C compiler with a large number of support files.

PICONET #22. BDS C functions for math, other.

PICONET #23. BDS C Users' Group disk.

PICONET #24. BDS C log, trig functions, float to octal.

PICONET #25. BDS C Users' Group Disk: file compression, concordance, merge, quicksort, etc.

PICONET #26. BDS C Users' Group disk: file handling, screen utilities.

PICONET #27. MORE YAM MODEM.

PICONET #28. BDS C utilities.

PICONET #29. ROFF text formatter.

PICONET #30. BDS C software tools: symbol table creation, SUBMIT, etc.

PICONET #31. Many games written in C.

PICONET #32. Z80 disassembler, extended directory, fast copy, bad sector lock-out.

PICONET #33. RCPM and MODEM software, CRC check, disk labels, PLINK, MBASIC unprotect.

PICONET #34. More SIL (See #19).

### CP/M PUBLIC DOMAIN COLLECTION #1

(CP/M only)

This is the first of DYNACOMP's CP/M public domain offerings. We chose to start with this particular nine-disk set because of a unique situation: documentation. Most of the programs in this set are described in a book published by People Talk Associates (see below). A word of caution, however. The People Talk book is vital (you probably will not be able to use the software without it), but it falls short of what would be expected from "commercial" documentation.

These disks contain both machine language and BASIC programs. You must have an 8080 or Z-80 microprocessor (usually the case) and Microsoft BASIC. These disks can not be applied toward DYNACOMP's 10%-20% quantity discounts. Be sure to state the disk number (e.g. CP/M-3) when ordering.

Price: \$17.95 book only  
\$ 4.95 per disk  
\$39.95 for 9-disk set  
\$53.95 for 9-disk set and book

#### DISK CP/M - 1 Disk Utilities

- Program to copy, erase files, etc.
- Hex/ASCII file dump.
- Directory Organizer.
- Squeeze/Unsqueeze programs to remove or add unnecessary spaces in programs.
- User Log: to save console input/output.

#### DISK CP/M - 2 Disk Utilities

- Disk cleanup program.
- Directory assistance programs.
- Directory alphabetizing with label printing.
- Wildcard rename utility.
- More convenient PIP.
- Unerase deleted files.

#### DISK CP/M - 3 Disk Utilities

- File sorting, directory listing.
- Disk library system.
- Program password protection utility; scrambler.
- Turn keys into functions/commands.
- Record sorter.
- Display contents of files.
- Spooler.

#### DISK CP/M - 4 Miscellaneous

- Poster generator (in BASIC).
- File comparer, scanner.
- File search (global).
- Find bad sectors and remove them from use.
- Gothic lettering program.
- Text file format and print.
- Submit CP/M commands in batches.
- Word counter.

#### DISK CP/M - 5 Communications

- Contains MODEM programs for use with the Hayes Smartmodem. Included is a documentation file (use the UNSQUEEZ program) which outlines the program controls. The Kaypro version contains a ready-to-run terminal program. Not recommended for the novice. Poorly documented in book with respect to what the files are on the disk.

#### DISK CP/M - 6 Games

- Eight games; some in BASIC, some in machine language:

BIORHYTHM	GOLF
BOGGLE	HORSE
CHASE	MAZE
BLACKJACK	MERCHANT

#### DISK CP/M - 7 Games

- Five games, some in BASIC, some in machine language:

ROCKET	OTHELLO
TRADE	PUZZLE (Interesting!)
WUMPUS	

#### DISK CP/M - 8 Miscellaneous

- Calendar creator (1752-4000 AD)
- Food inventory system.
- Calculator emulator.
- Label printer.
- Loan amortization table generator.
- Cash flow, ROI, for real estate.
- Spelling checker (in machine language).

#### DISK CP/M - 9 Typing Tutor

- An extensive typing tutor program written in BASIC.
- Program to examine and change contents of a file or a disk.

### KAYPRO USER'S GROUP (KUG) PUBLIC DOMAIN

(Kaypro only)

Calling all Kaypro owners! This collection of public-domain software was developed and selected specifically for the Kaypro 2, 4, and 10 computers. Our usual warnings (see the CP/M UG PUBLIC DOMAIN discussion) about public-domain software hold, but we think you will be very pleased with these volumes.

Price: \$ 8.95 per diskette (1-9 diskettes)  
\$ 7.95 per diskette (10+ diskettes)  
\$149.95 complete collection

Be sure to carefully specify your machine model (e.g., Kaypro 2-84), and diskette stock number (e.g., KUG #22) when ordering.

#### Brief descriptions:

KUG #1. AMODEM, area code/geographic location, copy program, LU library utility.  
KUG #2. NSWEEP, SQUEEZE, STOPDISK, STARWARS, TAXEX-83.

KUG #3. Disk cataloger, MODEM172, UNSPOOL, cash flow program.

KUG #4. Vocabulary drill, picture, arcade game.

KUG #5. Dragon picture, PIPMODEM, appointment calendar, unerase, password, file protector.

KUG #6. Kaypro documentation, key pad redefinition (older Kaypros), flight game.

KUG #7. Bartender helper, adventure, Morse code programs.

KUG #8. DESPOOL, DU disk utility, pictures, BASIC cross reference.

KUG #9. FINDBAD, ALGOL subset, PASSWORD, reflex builder, SUBMIT, and XSUB replacement.

KUG #10. Disk cataloger.

KUG #11. TEACHER: A basic teacher's aid (113K long!)

KUG #12. Store demo for Kaypro. TYPEWRIT.

KUG #13. LRUN20 (allows programs to be run from .LBR files - very useful), NSWP (great utility), directory lister.

KUG #14. Kaypro II memo, shopping list, cataloger.

KUG #15. Similar to #13.

KUG #16. Aliens game (see #4 for documentation), HAMLOG, ATOMIC, GROCERY, LUNAR.

KUG #17. MFDISK: A Uniform-like program for the 2, 4-84, and 10; a super utility.

KUG #18. Despooler, unerase.

KUG #19. SD (stop disk), BASIC tutorial, documentation on Perfect Writer.

KUG #20. SMODEM.

KUG #21. MO (turn on K-10 MODEM port), electronics program, othello, Morse code.

KUG #22. HELP - an interactive on-line documentation system.

KUG #23. OHELLO, LU, MAKE, REFINO referencer.



**SIG/M UG PUBLIC DOMAIN**  
(CP/M only)

This is another public domain collection similar to the CP/M UG set (see the discussion under CP/M UG PUBLIC DOMAIN for requirements, comments, war-

ranty, and discount limitation information). Because this library is so large, we have broken it down into two sets for rental; it would be a bit of a grind for you to make a copy of the entire library in the rental period allowed! (Note that a "volume" may include from one to four disks, depending on the disk capacity!) The price schedule is shown below.

FORMAT*	PURCHASE			RENTAL*		
	1-9 Volumes per volume	10-19 Volumes per volume	20+ Volumes per volume	Completed Set volumes 1-208	Volumes 1-100	Volumes 101-208
8-inch IBM 3740	\$ 8.95	\$ 7.95	\$ 6.95	\$ 699.95	\$ 89.95	\$ 99.95
DYNACOMP STANDARD FORMAT D5DD	\$ 8.95	\$ 7.95	\$ 6.95	\$ 699.95	\$ 89.95	\$ 99.95
DYNACOMP SPECIAL FORMAT D5DD	\$11.95	\$ 9.95	\$ 8.95	\$ 899.95	Not Available For Rental	
DYNACOMP STANDARD FORMAT S5DD	\$ 9.95	\$ 8.95	\$ 7.95	\$ 799.95	\$139.95	\$149.95
DYNACOMP SPECIAL FORMAT S5DD	\$13.95	\$11.95	\$10.95	\$ 999.95	Not Available For Rental	
DYNACOMP STANDARD FORMAT S5SD	\$14.95	\$12.95	\$11.95	\$1199.95	\$199.95	\$219.95
DYNACOMP SPECIAL FORMAT S5SD	\$17.95	\$15.95	\$13.95	\$1399.95	Not Available For Rental	
APPLE CP/M	\$ 9.95	\$ 8.95	\$ 7.95	\$ 799.95	\$139.95	\$149.95

\* See CP/M UG PUBLIC DOMAIN

Remember to clearly specify your machine's make and model, disk format, and the disk stock number (e.g., SIG/M UG#23).

Brief descriptions:

- SIG/M UG#1 Original Adventure run-time program. Requires 64K. Machine language.
- SIG/M UG#2 Original Adventure source code (FORTRAN).
- SIG/M UG#3 Expanded Z80 Original Adventure, run-time.
- SIG/M UG#4 Utilities: IBM 374X to CP/M conversion, CP/M 2.0+ bit map, CRC check, directory sort.
- SIG/M UG#5 8080/8085 CPU diagnostic, memory test, controller diagnostic.
- SIG/M UG#6 6502 simulator (machine language). Manual on disk.
- SIG/M UG#7 Bulletin board, file transfer utilities, North Star/Versafloppy transfer.
- SIG/M UG#8 PASCAL-CP/M file transfer, PASCAL interpreter, booter, XMODEM 3B (assembly language).
- SIG/M UG#9 Autostart, large file copy, IBM 3740 FINDBAD, directory utilities (most in assembly language).
- SIG/M UG#10 Journal index (CBASIC), MBASIC games, North Star BASIC patch for CP/M (run N\*BASIC under CP/M), 8080 disassembler.
- SIG/M UG#11 Z80 Original Adventure (run-time). Supercedes SIG/M UG#3.
- SIG/M UG#12 Cross reference index for CP/M UG#1-47, SIG/M UG#1-11; alphabetically by file type, then by filename.
- SIG/M UG#13 MITS-CP/M file conversion (requires MAC, 88-DCDD), super directory, spaces to TAB compression, HB FIG FORTH 1.1.
- SIG/M UG#14 CP/M HELP system (for MBASIC, MACRO-80, CBASIC, EBASIC, ALGOLM, C, FORTRAN, PASCAL, MAC, CP/M).
- SIG/M UG#15 Catalogs for CP/M UG# 1-42, SIG/M UG#1-3.
- SIG/M UG#16 DU disk utility, DC Hayes MODEM program, memory test.
- SIG/M UG#17 File scrambler, sorter, no-copy flag, system memory map, disk cataloger, XMODEM41.ASM, SYSGEN program, Tarbell disk utilities.
- SIG/M UG#18 Utilities: disk dump, area code/region search, file security (scrambles file if copy is attempted), disk search and bitwise modify.

- SIG/M UG#19 PASCAL/Z programs: linear programmer, stars, many demos.
- SIG/M UG#20 PCE system monitor (extensive). Requires C-MACRO assembler.
- SIG/M UG#21 PASCAL/Z games and utilities: .PAS source and .COM files: keyword index, author, calc, cplot, wumpus, cave.
- SIG/M UG#22 PASCAL/Z utilities: program concordance (very useful), insertion sort, sine/cosine, rnd, string functions, recipe programs.
- SIG/M UG#23 8085 disassembler and XREF (requires MBASIC), 8080/Z80 disassembler (ASM file).
- SIG/M UG#24 PASCAL/Z utilities: CP/M 2.2 FINDBAD, quick sort, othello, recipe, shell sort, XREF.
- SIG/M UG#25 Fixed-length disk sort system, data base system.
- SIG/M UG#26 Games, simple mailing label program, EE programs, ham notebook (requires CBASIC). Versa Floppy II BIOS (ASM).
- SIG/M UG#27 Advanced terminal systems confidence tests.
- SIG/M UG#28 PASCAL/Z small library, NAD accounts receivable, PASCAL programs.
- SIG/M UG#29 Catalogs for CP/M UG#43-51, SIG/M UG#4-11.
- SIG/M UG#30 Catalogs and documentation for SIG/M UG#12-28.
- SIG/M UG#31-38 Eight volumes of the Yale Catalog of Bright Stars, compiled by W. Warren of NSSDC. Volume 1 contains the documentation and MBASIC (5.2) programs. The rest contain data.
- SIG/M UG#39 IBM 374X-CP/M file conversion. Language analyzer (PLI).
- SIG/M UG#40 System support utilities: Variable map (BASIC), Huffman compression (.COM), text formatter, others.
- SIG/M UG#41 Cromemco CDOS-CP/M system support.
- SIG/M UG#42 SD Sales hard-disk support.
- SIG/M UG#43 Pidgin programming system, 8080 TINCMP compiler, file directory program.
- SIG/M UG#44 Various utilities. Perhaps most interesting is UNERA.
- SIG/M UG#45-47 Dungeon for PDP-11 (requires RT-11).
- SIG/M UG#48 Communications: MODEM73, UNSPOOL, XMODEM46 (all in ASM).
- SIG/M UG#49 Accounts payable/receivable, master database (PL/I).

- SIG/M UG#50 DTC hard-disk support, Z80 Sweet Talker voice synthesis support.
- SIG/M UG#51 1981 SIG/M information catalog.
- SIG/M UG#52 Disk catalog, BASIC-80 program un-protector (un-P; very useful).
- SIG/M UG#53 SAM76 update and documentation.
- SIG/M UG#54 Z80 command processor replacement (requires MAC assembler). Neat feature: capture console input/output and store it on disk.
- SIG/M UG#55 Catalogs and documentation for SIG/M UG#31-53.
- SIG/M UG#56-58 Musicraft music system. Two-pass compiler which creates music data files. Very interesting. Includes many examples, data files (e.g., oboe wave form).
- SIG/M UG#59 PISTOL (Portably Implemented Stack Oriented Language).
- SIG/M UG#60 Utilities: restricted disk directory, squeeze/unsqueeze, etc.
- SIG/M UG#61 Dan's Information Management System (DIMS) BASIC programs in source format (ASCII).
- SIG/M UG#62 Disk diagnostic (Z80, CP/M 2.X), text processor (PASCAL).
- SIG/M UG#63 Name and address programs, fast copy, PASCAL utilities and accounts receivables program.
- SIG/M UG#64 Name and address program extension (PASCAL).
- SIG/M UG#65 Bulletin board and utilities: BYE78.ASM, MODEM76.COM, submit file generator (ASM).
- SIG/M UG#66 Bulletin board and utilities: Apple CP/M MODEM program (ASM).
- SIG/M UG#67 Bulletin board and utilities.
- SIG/M UG#68 Utilities: 8080 emulator w/trace, 8080/Z80 assembler/editor, PLINK65 MODEM, UNSPOOL (all require assembler).
- SIG/M UG#69 Games and utilities: (PASCAL .PAS and .COM files): 3-D graphics, terminal installation, mileage.
- SIG/M UG#70 North Star BASIC programs on CP/M, FORTH 1.1 (ASM), assembler XREF (ASM).
- SIG/M UG#71 PASCAL games and utilities (.PAS and .COM): statistics, LISP, program execution profile, checkbook.
- SIG/M UG#72 PASCAL utilities: MODEM (DC Hayes 100), .PAS and .COM files.
- SIG/M UG#73 Utilities: file compare, Diablo printer driver, disk label printer, PROM-100 EPROM programmer, memory mapped video driver, VDM-1 patch. Most are in assembly language.
- SIG/M UG#74 Utilities: disk copy, compare, clock routines (for Godbout SS-1), DDT to MAC/ASM/MACRO-80, diary, system address locator, verifier, unerase, and more. Good collection. Need BASIC assembler.
- SIG/M UG#75 Games and graphics. FFT programs (in BASIC), shell sort (ASM). Special hardware programs.
- SIG/M UG#76 Portable C full screen oriented editor (from Doctor Dobb's). Must be compiled (in C language).
- SIG/M UG#77 ZCPR - enhanced replacement for CP/M's CCP (console command processor). Must be assembled (ASM).
- SIG/M UG#78 Miscellaneous utilities: calendar, paginate, various benchmark programs, MBASIC cross reference (in BASIC), TALK communications program.
- SIG/M UG#79 PL/I-80 user's group library: inventory systems, PL/I utilities.
- SIG/M UG#80 Games, mathematics and editor programs; .COM and .PAS files.
- SIG/M UG#81 PASCAL/Z utilities, editor and cross-reference programs.
- SIG/M UG#82 Complete JRT PASCAL language. Includes external functions for arctangent, cosine, exponent, and square root.
- SIG/M UG#83 ADM-31 "in context" editor. Touch typing tutor (in MBASIC) with several data files.
- SIG/M UG#84 Various program updates.
- SIG/M UG#85 Various utilities (.PAS and corresponding .COM files), super submit, pause.

- SIG/M UG#86 TRS-80 Model I CP/M programs, Omicron Mapper System. Memory test, fast copy, find bad sectors, super directory, squeeze/unsqueeze, wild card unerase, one drive file transfer.
- SIG/M UG#87 FED econometric model by Decision Sciences and Software. Requires CBASIC. CP/M help, MODEM help.
- SIG/M UG#88-90 SYSLIB: Three volumes of an integrated library of assembly-language utility sub-routines, including documentation. Must be assembled (.MAC files). An excellent collection.
- SIG/M UG#91 Extended DU disk utility, Z80 disassembler, 8080 to Z80 source code translator.
- SIG/M UG#92 6800 cross-assembler, remote bulletin board system (RBBS), little ADA (requires Polymorphic).
- SIG/M UG#93 MODEM updates.
- SIG/M UG#94 INDEXER, medical code directory in PASCAL.
- SIG/M UG#95 Z80 assembler, linker. 8080 disassembler, SSM EPROM programmer.
- SIG/M UG#96 CP/M 86 utilities: checksum, restricted directory list, findbad, password, print utility.
- SIG/M UG#97 PASCAL XREF, floating-point math package (.PAS and .COM), file combine.
- SIG/M UG#98-108 Eleven volume SYSLIB system of .MAC and .ASM utilities. Z80 command processor replacement, version 2. Configuration, compare, protect, path, many others.
- SIG/M UG#109 "The Secretary" word processor.
- SIG/M UG#110 dBasell and Super Calc programs.
- SIG/M UG#111 Hard disk utilities: backup, 5" to 8" file copy, North Star DOS - CP/M file transfer, extended ZIP.
- SIG/M UG#112 SIGNON remote bulletin board system.
- SIG/M UG#113 KERMIT IBM PC to host mainframe MODEM communications system.
- SIG/M UG#114 PISTOL version 2 - Portably Implemented Stack Oriented Language.
- SIG/M UG#115 Binary/ASCII file comparison, CP/M-DEC file transfer (in FORTRAN), memory checksum, unspooler.
- SIG/M UG#116 8080 Fig-Forth (ASM), console I/O disk storage.
- SIG/M UG#117 Catalog cross reference, key redefinition, Macros Toolkit.
- SIG/M UG#118 XLISP (experimental object oriented language).
- SIG/M UG#119 LBR - library filing and utility system. BYEII library file (MODEM file transfer).
- SIG/M UG#120 MODEM 901.
- SIG/M UG#121 MODEM updates for MDM7XX and Smart Modem.
- SIG/M UG#122 ZCPR2 for the 8080 microprocessor.
- SIG/M UG#123 Improved INKEY for BASCOM, 16-bit math for 6580-8048-Z80, 6502 disassembler, transformer design (BASIC), XMODEM74.LBR.
- SIG/M UG#124-125 ZPCR2 commands and SYSLIB upgrade.
- SIG/M UG#126 ROFF4 v. 1.50 text formatter and support modules.
- SIG/M UG#127 COMM7 communications program; requires PMMI MM-103 MODEM. LASM assembler.
- SIG/M UG#128 Bulletin board software updates, XMODEM for UNIX and VAX/VMS.
- SIG/M UG#129 dBasell order and inventory program. 64-file set of JRT PASCAL programs in LBR file.
- SIG/M UG#130 SIGNON system of programs for remote CP/M control. Requires MBASIC.
- SIG/M UG#131 Library of PASCAL/Z procedures and functions; SCR and .PAS files. Mostly character and text I/O manipulation. Also data smoothing, sorting, statistics, plotting. A good collection.
- SIG/M UG#132 Games and utilities; .PAS and .COM.
- SIG/M UG#133 Games and utilities; .PAS and .COM files. Extended-precision floating-point package, cattle feed analysis with linear programming.

SIG/M UG#134 Games and utilities; .PAS and .COM files.

SIG/M UG#135 Utilities: .ASM, .OBJ, .BAS files. Directory utility, lock/unlock, multiple file transfer, relocater system.

SIG/M UG#136 "Big Board" microprocessor board utilities, YAM disk index, health program (in BASIC), Osborne-1 MODEM patch.

SIG/M UG#137-138 Building energy design analysis package by the California Energy Commission. Requires MBASIC BRUN.COM.

SIG/M UG#139 MODEM updates. UN.COM to recover BASIC-80 programs.

SIG/M UG#140 Cross assemblers and utilities: M68000 cross assembler, 6502 and 6800 op codes, 6800 cross assembler, disk test, CP/M 2.2 extenders, simultaneous equations (FORTRAN).

SIG/M UG#141 Osborne, Kaypro and Big Board MODEM and dumb terminal programs.

SIG/M UG#142 MBASIC 5.2 Osborne games: Almazar adventure, baccarat, monopoly, goldmine, adventure creator, spacewar.

SIG/M UG#143 Packet radio (PASCAL) and utilities.

SIG/M UG#144 MX80 graph subroutines, 8080/Z80 mnemonic translator, wild card rename, Osborne autostart, USCD PASCAL directory display.

SIG/M UG#145 CP/M 80 and CP/M 86 utilities. Bi-directional paging, super directory.

SIG/M UG#146 CP/M 86 translations of CP/M 80 programs.

SIG/M UG#147 Calendar (BASIC), Apple dumb terminal program (ASM), bad block locator. Utilities for Compupro clock.

SIG/M UG#148 Updated LISP in PASCAL, prime finder, random number generator, banner program (all in PASCAL).

SIG/M UG#149 CP/M 86 Small C, XMODEM in FORTRAN, MODEM7 for Z100, Unix LU.

SIG/M UG#150 Citadel bulletin board in C. Z8001 Forth (adapted from Dr. Dobbs).

SIG/M UG#151 68000 Forth, DEC Rainbow 100 utilities.

SIG/M UG#152 CP/M 80 drive diagnostic for 1793 controller using DYSAN diagnostic disk. Ladder network analysis, wild card unqueeze, loudspeaker analysis.

SIG/M UG#153 XLISP for CP/M 86.

SIG/M UG#154 Forth F83 for CP/M 2.X, 8080 CPU. includes editor, assembler.

SIG/M UG#155 dBasell programs. Personalized form letters, mailing labels, etc.

SIG/M UG#156 XMODEM patch for TRS-80 2, 12, 16, and 16B. Format, sygen utilities.

SIG/M UG#157 Various CP/M 86 utilities. CP/M 86 version of MODEM7.

SIG/M UG#158 YAMC86 MODEM package.

SIG/M UG#159 TINCMP macro processor, META compiler-compiler. See Dr. Dobbs July/August 1981.

SIG/M UG#160 Apple II Videx console I/O program, XREF36.

SIG/M UG#161 Autodialer search for Osborne-1 with Hayes Smartmodem, utility which allows particular Osbornes to write Kaypro disks, keyboard redefinition.

SIG/M UG#162 Concurrent PASCAL S compiler and P/O compiler.

SIG/M UG#163 CBASIC User's Group collection. Bibliographic search database, memtest, console I/O capture, directory display, XREF for CBASIC.

SIG/M UG#164-167 REC - Regular Expression Compiler for CP/M 80 and CP/M 86 (ASM and .MAC). Includes many things written with REC, including CNVRT compiler, LISP compiler, etc. Extensive package. See also #173.

SIG/M UG#168-170 MODEM727 and COM725 updates with overlays for many machines (e.g., Morrow, Osborne, Xerox, etc.).

SIG/M UG#171 Forth-based MC68000 compiler. Atari to CP/M interface:

SIG/M UG#172 CP/M 86 and CP/M 80+ utilities. Epson and Okidata drivers.

SIG/M UG#173 More REC (see #164-167).

SIG/M UG#174 ROFF4, version 1.60 text formatter.

SIG/M UG#175 MODEM - CP/M 86.

SIG/M UG#176 Disk utility DU-V86, conditional submit, Z80 unqueeze, super directory.

SIG/M UG#177 DEC to CP/M transfer, CDOS 2.35 emulator, 8080 monitor, PIP patch for handshakes, CP/M map, sort and pack.

SIG/M UG#178 BDSC bulletin board and C programs.

SIG/M UG#179 CP/M plus BIOS for Godbout/Compupro, various C utilities.

SIG/M UG#180 MODEM for 6800 FLEX, labels for Diablo and Epson, Unix-like shell for CP/M 2.2, memory drive program for CP/M 2.2.

SIG/M UG#181 RT-11 to CP/M 86, mini-MODEM for MSDOS, MX80 plotter.

SIG/M UG#182 Linear regression in Nevada FORTRAN, statistics in N\*BASIC, eigenvalue calculator.

SIG/M UG#183 Updated YAM MODEM.

SIG/M UG#184-192 Release 3 of Richard Conn's enhanced Z80-based replacement for the CP/M CCP. Very complete and well documented system.

SIG/M UG#193 Biderirectional pager, Atari joysticks for Osborne, MX-80 utilities, passwords for .COM files, Z80 debugger.

SIG/M UG#194 Dot-matrix graphics driver, FORTRAN-80 plot, Turbo PASCAL graphing, MBASIC plot.

SIG/M UG#195 FLUFF mini-max algorithm (Dr. Dobbs, July 1984). Simplex algorithm (Byte, May 1984).

SIG/M UG#196 Keyboard redefinition, DOT enhancement, WordStar footnotes.

SIG/M UG#197 FIND, HELP, E.COM .LIB version of unqueeze.

SIG/M UG#198-199 Property management system for tenanted real estate. Requires dBasell.

SIG/M UG#200-202 ZCPR3 utilities.

SIG/M UG#203 CP/M80 to CP/M86 translator, FIND with cross reference.

SIG/M UG#204 CP/M 80 compiled Forth F83, BASIC compiler with Forth, Huffman compression program, META80.

SIG/M UG#205 Same as #204 but for 68000.

SIG/M UG#206 Printing and sorting routines. "Type" for binary, squeezed, library files.

SIG/M UG#207 Vfiler and dump for NEC APC. CP/M 86 print utilities.

SIG/M UG#208 META4 in 8080 code, IBM 3740 disk utility.

NOTE: SIG/M Volume 46 is not available in complete form for single-density and Apple CP/M. The file DTEXT.DAT is too large and can not be broken into smaller chunks.

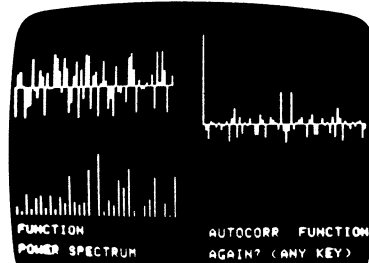

**CP/M UG PUBLIC DOMAIN**  
(CP/M only)

This is the well-known CP/M Users' Group Library which has formed the backbone of public domain software for the CP/M environment. Originally this library was available only on 8" disks. Now, through DYNACOMP, it is available not only in the 8" IBM 3740 format, but also in all of the standard and special CP/M formats handled by DYNACOMP (including Apple Z-80 CP/M); see below.

**Requirements:**

- 1) A CP/M format which DYNACOMP covers.
- 2) An 8080/Z-80 CPU for the machine language programs.
- 3) Some knowledge of how to load, list, etc., files. There are no printed manuals. The only documentation is on the disks themselves.

FORMAT*	PURCHASE 1-9 Volumes per volume	PURCHASE 10-19 Volumes per volume	PURCHASE 20+ Volumes per volume	PURCHASE Complete Set volumes 1-92	RENTAL** Complete Set volumes 1-92
DYNACOMP STANDARD FORMAT DSSD (or IBM 3740)	\$8.95	\$7.95	\$6.95	\$349.95	\$89.95
DYNACOMP SPECIAL FORMAT DSSD	\$11.95	\$9.95	\$8.95	\$399.95	Not Available For Rental
DYNACOMP STANDARD FORMAT SSDS	\$9.95	\$8.95	\$7.95	\$399.95	\$129.95
DYNACOMP SPECIAL FORMAT SSDS	\$13.95	\$11.95	\$10.95	\$449.95	Not Available For Rental
DYNACOMP STANDARD FORMAT SSSD	\$11.95	\$9.95	\$8.95	\$499.95	\$169.95
DYNACOMP SPECIAL FORMAT SSSD	\$17.95	\$15.95	\$13.95	\$599.95	Not Available For Rental
APPLE CP/M	\$8.95	\$7.95	\$6.95	\$349.95	\$129.95

\*SSSD=Single-Sided Single-Density  
 SDD=Single-Sided Double-Density  
 DSSD=Double-Sided Double-Density  
 DYNACOMP's "standard" 5 1/4-inch formats are: KAYPRO, OSBORNE, and MORROW. See the SPECIAL ORDER FORMATS box on the inside-front cover of this catalog for availability. Not available for North Star. The 8-inch IBM 3740 format is treated as equivalent to 5 1/4-inch DSSD; use the DSDD prices.

\*\*Rental is for 14 days. Master Card, Visa, or American Express charge cards only. If the set is not returned in 14 days, you will be charged \$10.00 per day extra up to the purchase price. Remember, others are waiting to rent the library!

Make sure that you specify:

- 1) Your machine make and model.
- 2) Whether the diskette(s) are to be single or double sided, single or double density. Eight-inch CP/M disks come in IBM 3740 format only.
- 3) The complete stock number (e.g., CP/M UG#3).

**Brief Descriptions:**

CP/M UG#1 Disk copy utilities, disassembler, disk test, memory test, paper tape to disk, games.

CP/M UG#2 Lawrence Livermore Laboratory BASIC and Disk Tiny BASIC.

CP/M UG#3 25 games in BASIC-E.

CP/M UG#4 ACTOR interpreter, ML80, FORTRAN-80 examples.

CP/M UG#5 BASIC-E compiler, interpreter, BASIC-E and MBASIC games.

CP/M UG#6 Checksum, file comparison, MODEM, mailing list, purge, sort, XREF.

CP/M UG#7 PILOT language.

CP/M UG#8 Utilities, binary load, disk test, multiply/divide, BASIC-E symbol table, XSTAT.

CP/M UG#9 General ledger programs.

CP/M UG#10 More LLL BASIC.

DYNACOMP's prices basically reflect the costs of the disk(s), and the copying and inventory expenses. The single-sided single-density formats cost the most because up to four SSSD diskets are required to hold the same contents ("one volume") as one 8" disk; DYNACOMP copies on only one side of single-sided diskettes for the sake of reliability and reduced head wear (yours and ours; other companies copy on both sides of single-sided disks. This results in much frustration when BDOS errors occur!)

The library may be purchased in part or as a whole, or rented as a whole, according to the schedule below. DYNACOMP will replace defective disks, but does not warrant the software on the disks (we did not write it!). These disks and diskettes may not be used in or toward DYNACOMP's 10%-20% quantity discounts.

Note: DYNACOMP maintains a large stock and ships within 48 hours; other public domain sources are exceedingly slow!

CP/M UG#11 Tiny BASIC, Processor Tech BASIC/5, PALO ALTO Tiny BASIC.

CP/M UG#12 More PILOT.

CP/M UG#13 BASIC-E, CBASIC and MBASIC games, utilities.

CP/M UG#14 Utilities: Disk viewer, dump, block move, put, sector display.

CP/M UG#15 Assembly and machine-language games, odd utilities.

CP/M UG#16 Z-80 assembler, disk copy, fast ED, FOCAL interpreter.

CP/M UG#17 Assembly and machine-language games, disk calculator.

CP/M UG#18 CASUAL language, math routines.

CP/M UG#19 Utilities: IBM 3740 disk editor, disk copy, MODEM link, directory sort, single disk copy and file transfer.

CP/M UG#20 BASIC-E and CBASIC games, posters.

CP/M UG#21 Microsoft BASIC games (20 of them).

CP/M UG#22 Big trek (requires 64K).

CP/M UG#23 STOIC (SStack Oriented Interactive Compiler).

CP/M UG#24 File dump, RATFOR for FORTRAN pre-processor, directory display.

CP/M UG#25 Form letter, Hayes MODEM, MITS 2510 MODEM, disk cataloger, STOIC.

CP/M UG#26 MBASIC and FORTRAN games: baseball, biorhythm, chase, civil war, cloud, galaxy, square, swarms, etc.

CP/M UG#27 Microsoft BASIC games, BASIC dis-assembler.

CP/M UG#28 BASIC-E utilities and games, ALGOL-M compiler and games.

CP/M UG#29 Assembler games, editor, FORTRAN sub-routines, file mover (disk-RAM-disk).

CP/M UG#30 BASIC-compiler, interpreter.

CP/M UG#31 Tarbell BASIC manual and assembler source code; Tarbell BASIC.

CP/M UG#32 Continuation of CP/M UG#31.

CP/M UG#33 Search-and-rescue programs, Flight log; require CBASIC, BASIC-E, MBASIC.

CP/M UG#34 SAM76 macro text processing language and utilities.

CP/M UG#35 FELIX graphics animation system—fairly extensive.

CP/M UG#36 Assemblers, editors, text processor related programs and utilities (find, combine, count, link, list, etc.).

CP/M UG#37 Arithmetic teaching (20 programs; requires CBASIC2), BASIC keyword changes.

CP/M UG#38 Tarbell controller programs, CP/M speed-up.

CP/M UG#39 Music programs; play three-part harmony through 8080 interrupt enable line. Includes many music files.

CP/M UG#40 Disk cataloging system, file comparing, multi-column directory display, disk sector read/write/search/bit map. MODEM4.

CP/M UG#41 Mail list maintenance, chess (machine language), moon location programs, Morse code assembly language programs. Math routines in FORTRAN.

CP/M UG#42 Conversational disassembler, clock routines, special hardware routines.

CP/M UG#43 Osborne accounts payable/receivable (requires CBASIC2).

CP/M UG#44 CBASIC2 general ledger and budget programs (including Osborne programs).

CP/M UG#45 Osborne/McGraw-Hill payroll with cost accounting (requires CBASIC2).

CP/M UG#46 Disk utilities: checksum, dump, patch, master directory, TDL mnemonic disassembler, memory map.

CP/M UG#47 Disk bit map, copy fast, MODEM7.

CP/M UG#48 BDS-C sampler disk (games in BDS-C).

CP/M UG#49 FORTRAN/RATFOR programs: astronomy, .REL concatenation, matrix inversion, FORTRAN source code for RATFOR, quick sort.

CP/M UG#50 PASCAL compiler and sample programs, CP/M1.4 and 2.2 speed up.

CP/M UG#51 STAGE2 macro programming language.

CP/M UG#52 COPYFAST V3.5 (controller independent), BATCH and varBATCH.

CP/M UG#53 Original Adventure (BDS-C).

CP/M UG#54 Xitan disk BASIC games/programs (50).

CP/M UG#55 Same as SIG/M UG#1.

CP/M UG#56 Same as SIG/M UG#2.

CP/M UG#57 Same as SIG/M UG#11.

CP/M UG#58 Same as SIG/M UG#4.

CP/M UG#59 Same as SIG/M UG#5.

CP/M UG#60 Same as SIG/M UG#6.

CP/M UG#61 Same as SIG/M UG#7.

CP/M UG#62 Same as SIG/M UG#8.

CP/M UG#63 Same as SIG/M UG#9.

CP/M UG#64 Same as SIG/M UG#10.

CP/M UG#65 Same as SIG/M UG#13.

CP/M UG#66 Same as SIG/M UG#14.

CP/M UG#67 Same as SIG/M UG#15.

CP/M UG#68 Same as SIG/M UG#16.

CP/M UG#69 Same as SIG/M UG#17.

CP/M UG#70 Same as SIG/M UG#18.

CP/M UG#71 Same as SIG/M UG#19.

CP/M UG#72 Same as SIG/M UG#20.

CP/M UG#73 Same as SIG/M UG#21.

CP/M UG#74 Same as SIG/M UG#22.

CP/M UG#75 Same as SIG/M UG#23.

CP/M UG#76 Same as SIG/M UG#24.

CP/M UG#77 Same as SIG/M UG#25.

CP/M UG#78 CP/M utilities: quick submit, bit map, repeat submit, single disk copy/file move, MBASIC program unprotect, Intel assembler XREF.

CP/M UG#79 MODEM programs for PMMI and Smart MODEMS.

CP/M UG#80 Cromemco structured BASIC programs: mail list, spelling, MBASIC to Cromemco, sorting routines, statistics, games.

CP/M UG#81 Autoload patch to CP/M, ED enhancement, text processor, submit nester.

CP/M UG#82 North Star BIOS routines.

CP/M UG#83 MuMath/MuSIMP enhancements, CBASIC2 complex math routines.

CP/M UG#84 MODEM v7.65, XMODEM v5.0.

CP/M UG#85 Squeeze and unsqueeze programs.

CP/M UG#86 Business Master II, Volume 1 (requires CBASIC2).

CP/M UG#87 Business Master II, Volume 2 (requires CBASIC2).

CP/M UG#88 Business Master II, Volume 3 (requires CBASIC2).

CP/M UG#89 Business Master II, Volume 4 (requires CBASIC2).

CP/M UG#90 Business Master II, Volume 5 (requires CBASIC2).

CP/M UG#91 Microsoft FORTRAN spectrum analysis programs (FFT, windowing, plot, etc.).

CP/M UG#92 THE SECRETARY word processing system. Same as SIG/M UG#109.

### HAVE YOU EVER WONDERED...?

Why does DYNACOMP use un-retouched black-and-white computer-screen photographs instead of fancy four-color art work to "push" its products?

Open a computer magazine and just look at the art work. Do it as an experiment. — Nice copy, isn't it? However, how much of this art work actually conveys *real* information about the product? How much of it leads you to *expect* things (e.g. graphics beyond the machine's capability, a beautiful secretary, fantasy, etc.) that are not really in the products? DYNACOMP's advertisements and catalog descriptions are simple and factual. However, even we have trouble restraining our advertising department on some of our products!

### ATARI PUBLIC DOMAIN COLLECTION #2 (Atari only)

We learn from experience. We introduced the ANTIC Public Domain collection in Catalog Number 26 and it was nicely received. That prompted us to search for additional material of the same type. This second collection of 38 disks is another "best buy". Each diskette is nearly full, and the programs are good to excellent. Individual diskettes may be purchased for \$7.95 each, or the entire collection may be obtained for \$199.95. Sorry, these diskettes may not be used toward DYNACOMP's 10%-20% quantity discounts. Remember to order by diskette number (e.g., PD#7). M/L = Machine Language.

#### Diskette PD #1 Price: \$7.95

BEGINTYP	Improve your typing
BOING	Catch bouncing Barney
CANNON	2-player cannon fight
CAPITALS	Learn the capitals
CUBES	Draw 3-D solid cubes
DDHELP	Dungeon & Dragon help
FLERead	Data-file reader
FUGE	Bach music for Atari
HURICANE	Hurricane locator
MATHPKG	Math functions
MLT0BAS	M/L to BASIC data conversion
RAYFLSR	Page flip GR. 7 demo
SIMON	Color/sound memory game
SPACE16	GR. 8 graphics demo
STRNGART	Color graphics demo
TARGET	Shooting gallery
TESTPAT	TV test pattern generator

#### Diskette PD #2 Price: \$7.95

ALIENSH	2-player shoot the UFO
BRDGBLDR	Build-the-bridge game
CASDISK	Autoboot cassette-to-disk
CHEMISTRY	Chemistry drill
DULCIMER	Instrument synthesizer
HANGQUOT	Hangman guessing game
INVASION	Shoot invading UFO's
KEYBOARD	Friendlier keyboard: M/L
MESSIAH	Music & graphic song
OLDGLORY	Song & flag graphics
PUFF	Puff the Dragon song
RENUMBER	BASIC renumber utility
SPACEATK	Space invaders
SUMER	Lead a country: graphics

#### Diskette PD #3 Price: \$7.95

DEFENDER	Like the arcade game
DESIGNS	Geometric patterns
ELIZA	Psychiatrist computer
QUEST	Graphic adventure
SAUCERLA	Arcade space battle
SKETCH	Graphic drawing system
SPIRSWIR	Fast colorful swirls
STARBASE	Arcade space zap game

#### Diskette PD #4 Price: \$7.95

BASEBALL	Graphic baseball for 2 players
BIORHTM	Plot your biorhythm
BUMBLE	Flight of the bumblebee
CONVOY	WW-II shipping game
DAIRY	Dairy farm simulation
DODGE	Dodge the mines
METEOR	Dodge the meteors
TOPOGRPY	Draws 3-D topographic maps

#### Diskette PD #5 Price: \$7.95

DUMPER	Examine Atari's memory
HORSERAC	Horse racing game
JUPLANDER	Land on Jupiter's moons
MAROOINED	Solar-system game
MAZE1	Multi-level 3-D maze
MAZE2	Giant Maze for MAZE1

#### Diskette PD #6 Price: \$7.95

PRETTY	Multimode graphic demonstration
MARQUEE	Color rotation demonstration
ELLIPSE	Draws 3-D ellipses
MEMTEST	Test your RAM
TRONSOUN	3 sounds from TRON
THROB	Pulsating color demonstration
ZIGZAG	Draws zigzagging patterns
UXB	Diffuse bombs arcade game
POLARGRA	Plots polar graphics
XIOFILL	XIO demonstration
DIAMONDS	Random high-resolution patterns
DRAW400	Portrait of Atari
SOUNDS	Sound routine designer
LASERGUN	Protect your Ion wall!
OUTPOST	Survive against the sea
SPIDER	Like Etch-a-Sketch™
FLICKER	Page-flip graphic demonstration
SPIRAGA	GR. 8 spirals TV/MX-80
TRIANGLE	Nice color graphics
DICEGAME	Gamble on dice rolls
SURVIVE	Super arcade game!

#### Diskette PD #7 Price: \$7.95

FORTH 1.4	Source code for FORTH
-----------	-----------------------

#### Diskette PD #8 Price: \$7.95

FORTH 1.4	Intro and demos for FORTH language
-----------	------------------------------------

#### Diskette PD #9 Price: \$7.95

JTERM	Start terminal software: Comm.
JTERMTEXT	Documentation for JTERM: Comm.
LOANS	A group of 28 business programs for investments, loans, depreciation, etc.

#### Diskette PD #10 Price: \$7.95

SALT2	An extensive testing program for Atari 400/800
FLAWTEST	Disk read/write test: Utility
RPMTEST	Check your disk RPM: Utility
BLKRABIT	Duplicate diskettes fast! Utility

#### Diskette PD #11 Price: \$7.95

WAR	Game of global conflict
AMODEM	Smart terminal software
WATRFALL	GTIA graphic demonstration
MYRAPPEDE	M/L centipede game
HOLLYMED	M/L graphics & sound demonstration
PINBALL	Pinball arcade game
VULTURES	Quality arcade game
KNIGHTS	Graphic adventure
TIMETRLS	Arcade race car driver

#### Diskette PD #12 Price: \$7.95

CHUTES	Arcade dodge 'em game
MANIAC	M/L arcade shoot-out
HARVY	Interesting M/L arcade game
TRUCKER	Truck driving simulation
TREE	Program in PILOT language
BOGGLER	A 2-player game
FILLERUP	M/L 'QIX'-like arcade game
OPART	Impressive graphic art
MDNTRIP	Night driver arcade game
MOTIE	GTIA graphic game
ORGAN	Musical Atari

#### Diskette PD #13 Price: \$7.95

TBIRD	Upside-down breakout
SGTPEPR	Beatles songs
WILDWEST	Catch the falling bombs
TIGER	Watch out for that tiger!
DARKTOWR	An adventure game
PROGLIB	Catalog your diskettes
ADVENTUR	Graphic adventure
PROGSORT	M/L sort for PROGLIB
DISKLABL	Make your own labels

**Diskette PD #14** Price: \$7.95

NSLAUGHT M/L Space arcade. NICE!  
 STARSHOT Arcade star wars  
 FILEINDEX Neat disk-indexing package  
 BATS Navigate through caves  
 FAUCET Nice GTIA demo  
 MENU MKR Disk menu maker

**Diskette PD #15** Price: \$7.95

STELLAR Defend the Humans!  
 AMODPLUS Supersmart modem  
 YAHTZEE Multiplayer Yahtzee  
 AUTODIAL Autodial with your Atari  
 AMDOC Info for AMODPLUS  
 DOGGIES Graphic game  
 CONCENTER Concentration game  
 BATCAVE Graphic dodge-the-bats game  
 FROGGIE M/L "Frogger" arcade  
 TRAGEDY Multiplayer dice game

**Diskette PD #16** Price \$7.95

SMOKEY Smokey & Bandit game  
 JELFISH Catch the fish  
 ASTROSTM Dodge the asteroids  
 MONOPOLY Neat! multi-player!  
 LONEAGLE Stop the horse thieves  
 PARATR Knock out the paratroops  
 GALACTIC M/L Galactic Chase. Super!  
 RPMTEST Check out your disk  
 SMALLDOS BASIC. DOS system  
 DUPFAST Fast disk copy system

**Diskette PD #17** Price \$7.95

STICKTST Test your joysticks  
 DUPL2D Disk duplicating program  
 CRICKETS Neat BASIC & M/L game  
 CRYPTO Cryptogram puzzles!  
 CHICKEN Cross that highway!  
 GRAVITY Great eye/hand test  
 BLKJACK Graphic blackjack game  
 PENTE Multiplayer board game  
 STONED Sound/graphic demo  
 ATLASCAN Atlas of Canada. Nice!

**Diskette PD #18** Price \$7.95

SABTAGE Can you break through?  
 ATTACK Space invaders!  
 DARTS Throw darts. Graphic.  
 BATLSHP A phone modem game!  
 WORDHUNT Word puzzles  
 DEMON Race car driver  
 TAPEDUPE Backup your M/L tapes  
 GR10PNTR GTIA painting program. NICE!  
 LIVEWIRE M/L Tempest Arcade!  
 SOLITAR Great graphic card game

**Diskette PD #19** Price \$7.95

LASERBAR Zap those alien ships  
 CRAZY8 Neat graphic card game

**Diskette PD #20** Price \$7.95

HOOKEY Q'bert clone  
 ESCHERSK Produce weird graphics  
 SAFRYLND Advanced Kingdom  
 GRUBS Kong-like capture game  
 NEWDUPSYS Advanced Atari DOS 2.1  
 ICECAVES Inside the 3-D maze  
 SOUNDLAB Design sound effects

**Diskette PD #21** Price \$7.95

DRAGON Burn those mutant apples!  
 CHOMPER Chomp those dots! M/L  
 ROUNDUP Just like in rodeos! M/L  
 DTESTEXE M/L 810 disk test system  
 MONSTER D & D type adventure  
 MENUPLUS Super disk menu system  
 SEADRAGON Neat graphic demo of game

**Diskette PD #22** Price \$7.95

SWORDEMO Graphic multicolor demo  
 MAGIC Neat GTIA demo!  
 FORMATIX EZ disk formatting system  
 AURABALL SUPER deluxe pinball! M/L  
 DOS3 Weird DOS SYS!  
 SNAKE How long can you survive?  
 CARDFILE Home filing system  
 RUBKUCUBE Solves your cube!

**Diskette PD #23** Price \$7.95

ONELINER 23 graphic demos  
 DISKTEST Test your drive and disks  
 MISSION Mission Impossible theme  
 DEMO Color graphics demo  
 SHERLOCK Action adventure maze  
 DEDITOR Disk sector editor  
 CATMOUSE Can you evade the cats?  
 DIGIDRAF Graphics painter and options

**Diskette PD #24** Price \$7.95

Graphics Slide Show!  
 A disk full of high-resolution digitized photographs.

**Diskette PD #25** Price \$7.95

PASSION NEAT music/graphics M/L!  
 CALENDAR Calendars from 1582 on ...  
 XMASSONG Atari composes your words  
 HOPPER M/L Frogger! Nice!  
 NIGHTFLY Aircraft simulation  
 XMSMUSIC Music and graphics demo. Nice!  
 SNOW More music and graphics!

**Diskette PD #26** Price \$7.95

50 music programs with BASIC-M/L song player. Also use with your Atari Music Composer cartridge.

**Diskette PD #27** Price \$7.95

TVTEST Test and align your TV  
 GAMBLER Las Vegas comes to you!  
 RECTRO Land on IO. Graphic M/L  
 JACKPOT Play the one-armed bandit  
 STRESS Measure your stress  
 MOZART Let Atari compose music  
 DISKCASS Dump binary files to tape

**Diskette PD #28** Price \$7.95

Advanced Music Player and popular tunes like Maniac, M.A.S.H., Classical Gas, Stairway to Heaven, and more.

**Diskette PD #29** Price \$7.95

DUNGEON Scott Adams-like adventure  
 POLYCOPY Multi-file copy utility  
 PINETOP Neat musical program  
 MLMENUMK Build fancy menu for M/L  
 MAPFRAG Scott Joplin tune  
 WORDSRCH Nice educational puzzle  
 MEMORY Concentration-like game  
 NERDII Are you a computer nut?

**Diskette PD #30** Price \$7.95

More Advanced Music tunes and player with Men at Work, theme songs from The Sting, Hill Street Blues, Knight Rider, and more!

**Diskette PD #31** Price \$7.95

Nine SUPER MicroPainter-type pictures with special auto-run viewer. Impressive!

**Diskette PD #32** Price \$7.95

PMDESIGNR Player-missile designer  
 ELECTRIC Track your electric bill  
 ADVENT5D Adventure in the 5th dimension  
 TITAN Planet mining simulation

**Diskette PD #33** Price \$7.95

WORLDPW Game of world domination  
 FONTEdit Nice character set editor! Utility  
 PENCILS M/L Graphics demo  
 CENTURIN Arcade space battle game  
 POKERSOL Solitaire poker. Graphics  
 KNIGHTS Adventure simulation game  
 SYN.OBJ Very nice music composer player.  
 Plays Atari Music Composer files such as on PD #26.  
 STARTREK The Movie theme song. For SYN.OBJ  
 JOPLIN Scott Joplin song for SYN.OBJ

**Diskette PD #34** Price \$7.95

Binary (machine/language) programs!  
 Includes favorites like AURABALL, RECTROFIRE, GALACTIC CHASE, MYRAPEDE, ONSLAUGHT, FROGGIE, and RACE IN SPACE! Over 70K of great machine-language fun! Includes colorful autorun menu.

**Diskette PD #35** Price \$7.95

GRAB Grab those apples!  
 BOXES 2-player fun!  
 STARS3D Impressive M/L effect  
 EPEST Epson printer codes  
 PHONE Track that phone bill  
 ATARI GTIA graphic demo  
 ORGAN Play the organ on Atari  
 SNOWDEMO Nice GR. 8 graphics demo  
 NATURE Educational quiz  
 MASMIND Master Mind game. Nice!  
 GR8TXT Mix graphics with text  
 GTIADEMO GTIA graphic demo  
 DOGGIES2 Improved version. Neat!

**Diskette PD #36** Price \$7.95

QUEST A major disk-based adventure!

**Diskette PD #37** Price \$7.95

AMODPLUS An advanced modem program  
 AUTODIAL Automatic dialing program  
 TSCOPE Telephone battleship program  
 SCANNER Scans local phone numbers  
 \*.DOC Documentation for above

**Diskette PD #38** Price \$7.95

HYPNOSIS Mesmerizing pattern generator  
 BATLRING M/L space arcade  
 TRON M/L light cycle arcade  
 CRASHDIV Submarine adventure  
 REPAIR Fix bad disks  
 SYSTATUS Displays system status

## ATARI COLLECTION #3

(Atari only)

This is the third collection of Atari public-domain programs which DYNACOMP is offering at "best buy" prices. This collection has some particularly nice material. No Atari owner should be without the utilities disks. Also, the music disks are exceptionally good.

Individual diskettes may be purchased for \$7.95 each, or the entire collection (26 diskettes) may be obtained for \$139.95, a savings of \$66.75 over the cost of buying them all separately. Sorry, these diskettes may not be used toward DYNACOMP's 10%-20% quantity discounts. Order by diskette code number (e.g., AC-4).

Each diskette is full. Below is an (incomplete) listing of the contents of each:

● **AC-1: Games**  
 RECTROFIRE, MANIAC, GRUBS, HAWKMEN, DEPTH CHARGE, SQUIRM, BIRDSTOP, RAINSTORM, CASTLEQ.

● **AC-2: Games**

ONE ON ONE, HORSE, CRASH DIVE, ENGINEER, STUNT MAN, GOBLIN, CHICKEN, GOLD RUSH.

● **AC-3: Games**

COLOR SLOT, BOWLER, BATS, FLIP IT, LUMBER JACK, SUBS, SIMON

● **AC-4: Games**

CENTURION, TRIDENT, POWER HOUSE, EPSILON, DEMON

● **AC-5: Games**

DARTS, RUNAWAY, CRYPTIC CAVERN, ABC SPORTS, KNIGHTS, DUNGEON

● **AC-6: Games**

MICROIDS, GAMBLER, SMOKEY, VOLLEY, ADVENTURE

● **AC-7: Education**

MATH KIDS, ID, MULTIPLY, SLIDE, MATH TIME, MAGIC BLACKBOARD, NOTE PRACTICE, NOTE OUT (Music)

● **AC-8: Education**

METRICS, RUSSIAN ROULETTE, WORLD, STATES, HANOI, ASTRONOMY, APTITUDE, AMERICAS, MORSE CODE, SPELLING BEE

● **AC-9: Utilities**

DISK CHECK, ALPHA DUMP, MAXIMENU, POLYCOPY, WEDGE, FONT, NEAT LIST, READ FILE, DIGITAL CLOCK, PATTERN MAKER

● **AC-10: Utilities (Super!)**

TIME CLOCK, TRACE, RENUMBER, HEX DEC, COPYCAT, RAM TEST, XREF, NO CLICK, SUPER COMPRESS, TOOL BOX, DOCTOR, DIRECTORY PRINT, LABEL PRINT, TV TEST, DISASSEMBLER, LISTER

● **AC-11, AC-12: Music**

(\$7.95 each. AC-11 is needed to play AC-12) STING, THRILLER, ENTERTAINER, MASH, SWEET DREAMS, EYE OF THE TIGER, plus 20 more!

● **AC-13, AC-14: Music**

(\$7.95 each. AC-13 is needed to play AC-14) SATURDAY NIGHT FEVER, BLOWING IN THE WIND, DREAM, RUBY, DYNASTY, ALLEY CAT, SMALL WORLD plus 18 more!

● **AC-15, AC-16: Music**

(\$7.95 each. AC-15 is needed to play AC-16) STAR WARS, CHARIOTS OF FIRE, BILLIE JO, MAGIC, plus 9 others!

● **AC-17: Games**

KISMET, OILWELL, UX8, NUCLEAR, GOMOKO, BOING, PHARAOH

● **AC-18: Games**

DRAGONLORD, ZURK, THIEF, KOOKY, HIGH SEAS, POPCORN, ROBOT, CRAZY8

● **AC-19: Adventures**

LIVINGSTON, SEARCH, TIGER, KIDNAP, VOLCANO

● **AC-20: Adventures**

STARWARP, HARRY, DEVIL'S CAVE, LOST, DOGBITE

● **AC-21: Education**

GEOMETRY, GEOQUIZ, GRAPHICS, ALCOHOL, BIORHYTHM, CALORIES, LIGHT, REMAINDER

● **AC-22: Education**

STICKS, POETRY, SIMON, COUNT, ADDITION, ROMAN, SCIENCE QUIZ, FLAGS

● **AC-23, AC-24, AMS Music**

(\$7.95 each. AC-23 is needed to play AC-24) SHAKE IT UP, RISING SUN, CALL ME, SUPERMAN, DOLLY, HEARTACHE, SWORD, CHOPIN, and more.

● **AC-25: Utilities**

SYSTAT, TEXT PLOT, DUPFAST, HEX POKE, LINE MOVE, BUBBLE SORT, CRAB, WIDE TEXT, DISK DUMP, CATALOG, and more.

● **AC-26: Graphics**

Secrets of Atari Graphics

**THE ANTIC®  
PUBLIC-DOMAIN SOFTWARE  
LIBRARY**  
(Atari only)

Good news for Atari and Atari XL owners!

DYNACOMP now distributes the public-domain software library compiled by ANTIC® magazine. These diskettes contain classic computer programs translated to the Atari (with enhancements) as well as material written specially for that machine.

The library presently consists of well filled diskettes covering games, utilities, graphics, communications, and music. ANTIC® distributes these diskettes for \$10 each. DYNACOMP, because of its higher volume/overhead ratio, offers them for only \$7.95 each, an exceptional value. Also, you may purchase collections of these diskettes at substantial discounts (less than half ANTIC's price):

Collection	Price
A: ANT- 1 to ANT-27	\$129.95
B: ANT-28 to ANT-55	\$129.95
C: ANT- 1 to ANT-55	\$249.95

Sorry, these items cannot be used towards DYNACOMP's 10% - 20% quantity discounts.

Be sure to carefully identify which diskettes you want (for example, ANT-7). No manuals are included. The programs are generally self-prompting or magazine references are given.

Note that DYNACOMP's numbering system is not entirely the same as that used by ANTIC® magazine. Compare by contents.

**ANTIC® GAMES: Diskette No. ANT-1**  
CHICKEN, HANGMAN, CREATION, REVERSE, MONOPLY, LUNAR LANDER, ZONEX, CLEWSO

**ANTIC® GAMES: Diskette No. ANT-2**  
SPEED DEMON, DEATH STAR, BLACKJACK, CIVIL WAR, ARTILERY, SUPER WUMPUS

**ANTIC® GAMES: Diskette No. ANT-3**  
PETALS, SHOWDOWN, FROG, DRAW, PLUS ZERO, COLLOSI

**ANTIC® GAMES: Diskette No. ANT-4**  
VULTURES, CASTLE HEXAGON, ADVENTURE, ADVENTURE CREATOR

**ANTIC® GAMES: Diskette No. ANT-5**  
BATS, STELLAR DEFENSE, YAHTZEE, MASTERMIND, HAMURABI, SLALOM, COUCH, ACEY-DUCEY

**ANTIC® UTILITIES: Diskette No. ANT-6**  
DOC, MICROASSEMBLER, ASSEMBLE-EDITOR (in BASIC), RENUM, MEMTEST, COLOR, PARALLEL PRINTER

**ANTIC® UTILITIES: Diskette No. ANT-7**  
BUBBLE SORT, TYPO, HOME INVENTORY, CIPHER, RENUMBER, COMPARE, SUPER MENU, MODEM, REAL-TIME CLOCK

**ANTIC® UTILITIES: Diskette No. ANT-8**  
DISASSEMBLER, TINY TEXT, GTIA TEXT WINDOW, EPSON LABEL, MX80 VISICALC, PRINTER SETUP, KEYBOARD TUTORIAL

**ANTIC® GRAPHICS: Diskette No. ANT-9**  
SPIDER, RAINBOW, HORSES, ATARI LOGO, OXYGEN, SPIRAL, PRETTY, MESSAGE

**ANTIC® MUSIC: Diskette No. ANT-10**  
GRAPHIC, DRAW, RAINBOW, TUNE RITE, ETCH SKETCH, BABY PRO SOUND

**ANTIC® MUSIC: Diskette No. ANT-11**  
PRELUDE, JOPLIN, IN MY LIFE, STAR TREK, DAISY, GREENSLEEVES, YELLOW SUBMARINE, and more!



**ANTIC® PHOTOGRAPHY: Diskette No. ANT-12**  
DIGITIZED PHOTOS

**ANTIC® Diskette No. ANT-13**  
FUGUE, HAPPYDAY, STARWARS, PIANO, HARMONICA, SOAP, BEETS 5th, MASH, SONATA

**ANTIC® Diskette No. ANT-14A**  
FIG FORTH (Part A)

**ANTIC® Diskette No. ANT-14B**  
FIG FORTH (Part B)

**ANTIC® Diskette No. ANT-15**  
FINANCE, IRA, NPV, BIGNUM, SINKFUND, BANKBAL, BUSINESS

**ANTIC® Diskette No. ANT-16**  
BARNYARD, QUIZ, MATHWARS, CONCEN, ADDING, FUNCTION

**ANTIC® Diskette No. ANT-17**  
DLINK, DISKLINK, AMODEM, TSCOPE

**ANTIC® Diskette No. ANT-18**  
FISH, GRAVITY, DEFENSE, PIG, THREENIM, LANDER II, MOONBASE, SWUMPUS, TAG

**ANTIC® Diskette No. ANT-19**  
HERBIE, SMOKEY

**ANTIC® Diskette No. ANT-20**  
MYRIAPED, CREEPSHW, BLACKHOLE

**ANTIC® GAMES: Diskette No. ANT-21**  
CALAMITY, GRIDMASTER, JEOPARDY, DECODE, DIGGER, HIDDEN, SLAMMER, JUMPING

**ANTIC® GAMES: Diskette No. ANT-22**  
HATS, ANTIPONG, BAYPILOT, TAXMAN, TYPOTIME, and more!

**ATARI® TRANSLATOR: Diskette No. ANT-23**  
This diskette is *not* from ANTIC®, but we have included it here to get our numbering system in sync with ANTIC's. It is available for \$5 plus postage and handling if ordered under the name "Atari Translator®".

**ANTIC® COMMUNICATIONS: Diskette No. ANT-24**  
AMODEM, AUTOGEN, DISKLINK, TSCOPE, BOOT232

**ANTIC® COMMUNICATIONS: Diskette No. ANT-25**  
THANDLER, TERM1030, DISKLINK

**ANTIC® UTILITY: Diskette No. ANT-26**  
The XL-FIX; 800 operating system overlay for XL and XE models.

**ANTIC® ADVENTURES: Diskette No. ANT-27**  
DAIRY, SAFARILAND, TITAN, DUNGEON, HORSERACE, HURRICANE

**ANTIC® GAMES: Diskette No. ANT-28**  
BOGGLER, CUBES, DARK TOWER, DODGE, METEOR, PINBALL, WAR, DUMPER, SHOOT, OUTPOST, more!

**ANTIC® GAMES: Diskette No. ANT-29**  
JELLY FISH, QUEST, CONVOY, SHERLOCK, SABOTAGE, MINIGOLF

**ANTIC® GAMES: Diskette No. ANT-30**  
TILTER, TRAGEDY, BALLOONS, EGGS, KNIGHTS, WILD-WEST, SEA HUNT, BOXES, TANKS, and more!

**ANTIC® GAMES: Diskette No. ANT-31**  
SMUSH, FROGGIE, CHOMPER, ROUNDUP, MORDIC

**ANTIC® ADVENTURE: Diskette No. ANT-32**  
WEREWOLF, TITANIC, LIVINGSTON, TREASURE

**ANTIC® CROCKFORD'S WHIMSEY: Diskette ANT-33**  
BALLONE, BALLTWO, INTERVAL, HOLLYMED, JANES

**ANTIC® GAMES: Diskette No. ANT-34**  
BIGTOP, GALLERY, WORDGUESS, MASONS, MONKEYS, EAGLE, and more!

**ANTIC® GAMES: Diskette No. ANT-35**  
Machine-language, fast games: ERG, DIAMOND, TRICKY

**ANTIC® COMMUNICATIONS: Diskette No. ANT-36**  
Autodialer telephone database: 100-name database, prints labels. Requires 850 interface.

**ANTIC® COMMUNICATIONS: Diskette No. ANT-37**  
VT100 graphics terminal emulator. Supports Hayes (with 850 interface), 835, 1030, and MPP1000 modems.

**ANTIC® COMMUNICATIONS: Diskette No. ANT-38**  
Kermit terminal emulator to communicate with KERMIT-based systems. With 850 interface, it supports Hayes, 835, and 1030 modems.

**ANTIC® UTILITIES: Diskette No. ANT-39**  
FIXXL by Belathiel and Friar John.

**ANTIC® COMMUNICATIONS: Diskette No. ANT-40**  
MSCOPE MPP CompuServe terminal emulator (TSCOPE for MPP1000 series modems).

**ANTIC® UTILITIES: Diskette No. ANT-41**  
HomePak customizer: change character sets, key repeat rate, bell, auto linefeed, new DOS 2.5 patch, RAM disk patch to use extra 64K.

**ANTIC® ANIMATION: Diskette No. ANT-42**  
Dancing Robots, Swarming Birds, Charlie Chaplin, New Year's Juggler, and four more. Includes Movie Maker auto player.

**ANTIC® UTILITIES: Diskette No. ANT-43**  
ArDOS automatic graphics and character-set loading system. Includes 10 pictures, 20 character sets.

**ANTIC® EDUCATION: Diskette No. ANT-44**  
Six mathematics games, geometry and algebra equation plotters, geography, English/French hangman.

**ANTIC® EDUCATION: Diskette No. ANT-45**  
FUNCTION, SPELLBEE, AMERICAS, MATHPKG, more. By C.U.E.S.

**ANTIC® UTILITIES: Diskette No. ANT-46**  
EPSON TYPIST, SYSTAT, PROTECT, AUTOTYPE, and 14 more.

**ANTIC® UTILITIES/DATABASE: Diskette No. ANT-47**  
SUPINDEX, DISKDIR, SECTCHECK, CALENDAR, QUICKSORT, SUPERDUP.SYS.

**ANTIC® PROGRAMMING TOOLS: Diskette No. ANT-48**  
FONTEEDIT, PMDESGNR, SKETCH, SOUNDLAB, DATABASE, and more.

**ANTIC® MUSIC: Diskette No. ANT-49**  
PAPERBACK WRITER, SHE LOVES YOU, ELEANOR RIGBY, LUCY IN THE SKY, LOVE ME DO, NOWHERE MAN, I WANT TO HOLD YOUR HAND, YESTERDAY, NORWEGIAN WOOD.

**ANTIC® MUSIC: Diskette No. ANT-50**  
JUMP, ROXANNE, THRILLER, WE ARE THE WORLD, GHOSTBUSTERS, LIKE A VIRGIN, GIRLS JUST WANT TO HAVE FUN.

**ANTIC® MUSIC: Diskette No. ANT-51**  
TAKE THE A TRAIN, SATIN DOLL, TAKE FIVE, BIRD, IN THE MOOD, RHAPSODY IN BLUE, SODA FOUNTAIN RAG, SUMMERTIME, LUSH LIFE, and more.

**ANTIC® SPEECH SYNTHESIS: Diskette No. ANT-52**  
HACHRIC and VANHALEN digitized human voice experiments. Digitally sample speech through tape recorder. interesting!

**ANTIC® GRAPHICS: Diskette No. ANT-53**  
PD MICROPAIN ARTIST by Greg Tavares: Machine-language graphics generation program with drawing, stretching, zoom, fill, etc. Super disk!

**ANTIC® GRAPHICS UTILITIES: Diskette No. ANT-54**  
Epson screen and character dumps, GTIA screen loader, graphics demos.

**ANTIC® UTILITIES: Diskette No. ANT-55**  
ASSEMBLER, DISASSEM, RAMSORT, DOS3T02, RELOCBIN, BINMENU.

**ANTIC® EDUCATION: Diskette No. ANT-57**  
Not available. Won't run on 400/800, XL, or XE series.

**ANTIC® ENTERTAINMENT: Diskette No. ANT-58**  
Not available. Won't run on 400/800, XL, or XE series.

**ANTIC® COMMUNICATIONS: Diskette No. ANT-59**  
AMODEM85 autodial system.

**ANTIC® GRAPHICS: Diskette No. ANT-60**  
High resolution graphics demos. Five pictures (not worth getting; included only for completeness).

**ANTIC® TACTICS & WITS: Diskette No. ANT-61**  
WORDHUNT, HAMURABI, THREENIM, CIVILWAR, QUBIC, and more.

**ANTIC® PUZZLES: Diskette No. ANT-62**  
Contains several mystery and adventure programs: CLEWUS, QUIX, PANTHER, TAG, BIRTHDAY, NEWDOORS, OILWELL, STRATEGY.

**ANTIC® ASTRONOMY: Diskette No. ANT-63**  
Contains 5 programs: ASTRONOMY, SOLAR SYSTEM, HALLEY, PLANETARIUM, and HURRICANE. The first one is particularly nice.

**ANTIC® ELECTRONICS: Diskette No. ANT-64**  
OSCAR orbit predictor, LCCOMP, PADPIX, RFCOIL, CODETEST, EFORMS, YAGICAL, RESISTOR, and more. Ham radio heaven!

**ANTIC® GRAPHICS: Diskette No. ANT-65**  
Atari 130 XE graphics demonstrator. The disk is half full of pictures. Will not run on 400/800 series.

**ANTIC® HOME USE: Diskette No. ANT-66**  
Gift selector. This is not much of a program, and we don't recommend it. It is included only for completeness.

**ANTIC® UTILITIES: Diskette No. ANT-67**  
DOS 4.0. Includes RS232 handler. Will read DOS 2.0 and DOS 3.0 disks, has full utilities, allows easy change of disk drive parameters. Supports 810/1050 drives. A handy disk to have!

### REWARD!

One of the more curious debates appearing in the computer magazines (and elsewhere) is whether or not violating the copyright laws by copying software is justified or not. Those who think that such stealing is acceptable have all sorts of arguments aimed at rationalizing their behavior.

Quite frankly, we believe that it is pointless pursuing philosophical discussions in this area. Copyright violators should instead be given the opportunity to tell their story to a judge! That way they would soon learn "which way is up".

DYNACOMP's approach is simple. We will give a 25% reward to anyone who supplies us sufficient evidence to prosecute a copyright infringer. This reward will be based on the cash damage settlement awarded DYNACOMP, namely the lost sales damages and the punitive damages (These are the big ones. The fines are large!). The court cost and attorney fee award is not included; it will be used to cover DYNACOMP's legal expenses.

DYNACOMP and the FBI (we have been working with the Rochester FBI office) will make every effort to keep your identity confidential. If you would prefer to contact the FBI directly, direct your information to Mr. Gil Cooper, Federal Bureau of Investigation, 100 State Street, Room 300, Rochester, NY 14614.

Incidentally, ignorance of the copyright law is not a good defense; a school district recently paid over \$300,000 to find that out!

## THE DYNACOMP BOOK COLLECTION

### DISCOUNTS

If you purchase 3 to 4 books, you qualify for a 10% discount. At the 5 plus level, deduct 20%. Also, DYNACOMP's software-dealer discount schedule also applies to books. Note, however, books and software are discounted separately.

### SHIPPING AND HANDLING

For orders to be delivered within the continental United States, please include \$2.00 shipping and handling for the first book, and \$1.00 for each additional book. For orders to be delivered outside the continental United States, please include \$6.00 for the first book, and \$4.00 for each additional book. Orders mailed outside the United States are shipped via surface mail.

BASIC SCIENTIFIC SUBROUTINES, VOLUME I by Dr. F. R. Ruckdeschel

See SCIENCE and MATHEMATICS section for a description.

316 pages, hard cover Price: \$29.95

BASIC SCIENTIFIC SUBROUTINES, VOLUME II by Dr. F. R. Ruckdeschel

See SCIENCE and MATHEMATICS section for a description.

790 pages, hard cover. Price: \$29.95

NOTE: Both Volume I and Volume II are now available in Japanese and Spanish.

### BOOKS FROM DYNACOMP

DOING BUSINESS WITH SUPERCALC by Stanley R. Trost (248 pp., illustrated) .....	\$14.95
THE BEST OF CP/M SOFTWARE by Alan R. Miller (250 pp., illustrated) .....	\$14.95
THE CP/M HANDBOOK by Rodney Zaks (320 pp., 100 illustrations) .....	\$14.95
MASTERING CP/M by Alan R. Miller (398 pp., illustrated) .....	\$17.95
PROGRAMMING THE Z80 (3rd Ed.) by Rodney Zaks (624 pp., 200 illustrations) .....	\$19.95
THE SYBEX PERSONAL COMPUTER DICTIONARY (120 pp., 1,600 definitions) .....	\$3.95
MASTERING VISICALC by Douglas Hergert (217 pp., illustrated) .....	\$15.95
INTRODUCTION TO WORDSTAR (2nd Ed.) by Arthur Naiman (202 pp., illustrated) .....	\$16.95
PRACTICAL WORDSTAR USES by Julie Anne Arca (200 pp., illustrated) .....	\$16.95
APPLE II BASIC PROGRAMS IN MINUTES by Stanley R. Trost (170 pp., illustrated) .....	\$12.95
YOUR FIRST ATARI PROGRAM by Rodney Zaks (150 pp., illustrated in color throughout) .....	\$12.95
FROM CHIPS TO SYSTEMS: AN INTRODUCTION TO MICROPROCESSORS by Rodney Zaks (552 pp., 400 illus.) .....	\$19.95
YOUR FIRST COMPUTER by Rodney Zaks (258 pp., 150 illustrations) .....	\$ 9.95
THE COMMODORE 64 BASIC HANDBOOK by Douglas Hergert (170 pp., illustrated) .....	\$14.95
THE EASY GUIDE TO YOUR COMMODORE 64 by Joseph Kaszmer (160 pp., illustrated) .....	\$ 9.95
CELESTIAL BASIC: ASTRONOMY ON YOUR COMPUTER by Eric Burgess (300 pp., 65 illus. & photos) .....	\$16.95
PASCAL PROGRAMS FOR SCIENTISTS AND ENGINEERS by Alan R. Miller (374 pp.) .....	\$17.95
THE PASCAL HANDBOOK by Jacques Tiberghien (486 pp., 270 illustrations) .....	\$19.95
PROGRAMMING THE 6502 by Rodney Zaks (386 pp., 160 illustrations) .....	\$14.95
ADVANCED 6502 PROGRAMMING by Rodney Zaks (292 pp., 140 illustrations) .....	\$15.95
INTRODUCTION TO PASCAL (INCLUDING UCSD PASCAL) by Rodney Zaks (420 pp., 130 illustrations) .....	\$17.95
UNDERSTANDING C by Bruce H. Hunter (200 pp., illustrated) .....	\$17.95
6502 APPLICATIONS by Rodney Zaks (278 pp., 200 illustrations) .....	\$14.95
BASIC EXERCISES FOR THE ATARI by J. P. Lamoitier (251 pp., illustrated) .....	\$14.95
THE IBM PC-DOS HANDBOOK by Richard Allen King .....	\$16.95
ESSENTIAL PC-DOS by Myril Clement Shaw & Susan Soltis Shaw .....	\$15.95
8086/8088 APPLICATIONS by James W. Coffron .....	\$19.95
MASTERING APPLE WORKS by Elna Tymes .....	\$15.95
THE MACINTOSH BASIC HANDBOOK by Thomas Blackadar & Johathan Kamin .....	\$24.95
THE PRODOS HANDBOOK by Timothy Rice & Karen Rice .....	\$15.95
THE CP/M PLUS HANDBOOK by Alan R. Miller .....	\$15.95
THE ABC'S OF THE IBM PC by Joan Lasselle & Carol Ramsey .....	\$13.95
THE EASY GUIDE TO YOUR MACKINTOSH by Joseph Caggiano .....	\$12.95
THE RS-232 SOLUTION by Joe Campbell .....	\$16.95
THE MS-DOS HANDBOOK by Richard Allen King .....	\$16.95

DYNACOMP is one of the world's largest distributors of micro-computer software. As such, we purchase supplies and hardware in large quantities and at greatly reduced prices. Let DYNACOMP become your source for the highest quality supplies at the lowest prices available.

### 5¼" DISK DRIVE HEAD CLEANING KIT

If you have used your disk drive extensively, and once in a while you get a disk I/O error, then it is possible\* that your disk drive head may be getting dirty. If so, you can either disassemble your drive and clean the head directly (we do this for our 8-inch drives), or use a head cleaner diskette (as we do for our 5¼" drives).

Although it is said that "dry" cleaning works as well as "wet", it is our opinion that the wet method offers less chance for abrasion. The kit carried by DYNACOMP (and used in our lab) comes with a double-sided cleaning disk and a bottle of special solvent. Just put a few drops of solvent on the cleaning disk and "read" the disk for 15 to 30 seconds. You may be surprised how much dirt may come off!

Price: \$7.95 per kit

\* There are several other possible reasons for a disk I/O error. If you do *not* have much mileage on your drive, the most likely source of the problem is the diskette itself. Another potential cause is head misalignment (not easily fixed without test equipment).

We have also encountered several cases in which the pressure pad (on single-sided drives) has worn out. This is easy to check by eye and simple to replace (proceed carefully!) You really have to put a lot of hours in on a drive to wear out a pressure pad. However, low grade (not micro-smooth or mirror-finish) diskettes greatly accelerate this failure.

### MAILING LABELS

We recently had the opportunity to visit a Radio Shack store and were amazed at some of the prices (high). One particularly high-priced item was tractor-feed one-up (15/16" x 3½" by 12 per fan fold) mailing labels. DYNACOMP uses the same labels for its catalog mailings, and usually we purchase a few hundred thousand at a time. Therefore, DYNACOMP gets a very good volume price break and can pass some of those savings on to you.

Price: \$3.95/1,000 (1,000 to 4,000)  
\$3.49/1,000 (5,000 and up)

Minimum order: 1,000 labels  
Orders must be in multiples of 1,000 labels.  
Shipping is \$3.50 per order, independent of quantity.

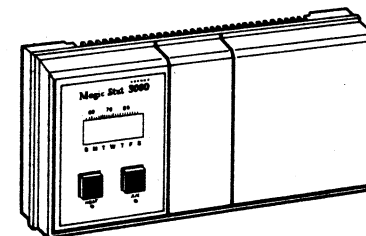

### CARDBOARD MAILERS

If you send disks or diskettes through the mail, you have had two choices. You could spend time to cut up cardboard boxes to make a protective sandwich for your floppy, or you could buy a mailer for from 75¢ to \$1.50 (or more).

Now DYNACOMP offers a third and **much** less expensive solution to your mailing problem. For five years DYNACOMP has been shipping disks and diskettes through the U. S. mail using cardboard boxes made especially for DYNACOMP. During that time, only one diskette has been damaged, and that was

under curious conditions (a determined mail carrier somehow managed to *fold* the box, probably using both hands and a foot). Now DYNACOMP offers these same mailers to its customers at quantity savings.

Each box comes unfolded (flat), cut to shape, and scored at the folds. You simply fold it up and tape it. We use a good grade of stiff cardboard and the construction is exceptionally strong.

The 5¼" diskette mailers hold one, two, or three diskettes. The 8" disk mailers have three crease positions and can accommodate from one to six disks.

ITEM	PRICE/EACH	QUANTITY
5¼" Diskette Mailer	25¢	10 to 24
	22¢	25 to 49
	20¢	50 to 99
	18¢	100 or more
8" Disk Mailer	50¢	10 to 24
	44¢	25 to 49
	40¢	50 to 99
	36¢	100 or more
Shipping & Handling	\$3.50	1 to 100 mailers
	\$3.00	each additional 100

Minimum Order: 10 pieces      Shipped via United Parcel Service



**APPLESAVER™ FAN**

Quite frankly, most Apple IIs do not need a fan to keep them cool. They run warm, but not so hot as to create a problem. However, if you also have extra boards plugged in, or are doing a significant amount of disk access (the disk drives are powered by the computer) the insides of your Apple II can heat up. A rule of thumb (the Arrhenius relation) predicts that the component failure rate should roughly double for each 10° F increase in temperature. Therefore it pays to keep your computer cool.

The APPLESAVER™ FAN does just that. It attaches to the side of your Apple using two plastic clips which slip into the air slots. Air is drawn across the inside back of the machine. The fan itself is very quiet, though effective. Also, the back of the unit contains two grounded AC sockets for plugging in your computer, monitor, etc. The front has a power switch (Apple type) and indicator lamp. Therefore you need only flip the fan switch to turn on your system as well as the fan.

the APPLESAVER™ FAN is very well built. The fan itself is of high quality, and the molded plastic housing is of the same material (and color) as the beige apple case. We use these units ourselves.

Includes surge protection.

Now for the really good news. Similar Apple fan units have been advertised nationally for \$89.95. DYNACOMP's price is only \$49.95! Comparison shop, and you will find our price to be exceptionally low.

Price: \$49.95

Dealer inquiries invited. We're going for volume on this one!

**PHONE FORWARD  
AUTOMATIC CALL FORWARDER**

PHONE FORWARD is an easy-to-install and easy-to-use phone accessory which allows you to re-direct incoming phone calls. For example, you may go to your cottage for a visit and would like to have your home phone calls transferred there. Or, you may want to redirect calls from home to your office; or you may have changed office locations.

You must have a two-line phone with standard two-line modular jacks (or adaptors) to use PHONE FORWARD. It can be either dial or touch-tone service. PHONE FORWARD is simply plugged in. Using the keyboard on the PHONE FORWARD you enter the phone number (including long-distance codes) to be dialed. Then, any call coming in on one line will be re-dialed and sent out on the other line.

DYNACOMP first came upon PHONE FORWARD in the Markline catalog (for \$129.95). We got three and used them for more than six months to transfer calls from our Rochester offices to our new offices in Webster. We were very pleased with the results, especially considering how expensive the alternatives were (phone company transfer service charges and other devices).

Limitations: a) You must type in the number; you cannot set the re-dial number from a remote location. b) If the phone traffic is heavy (many calls on both lines) and the phone service is poor, and you have an automatic search system, then it is best to have a line installed just for the re-dialed outgoing calls. c) If the re-dialed number is in another exchange, there may be some volume loss in the transmission.

Conclusion: We love it—and we think that it has a good price/performance ratio, too.

DYNACOMP's Discount Price: \$99.95

**SURGE PROTECTOR OUTLET STRIP**

This is one of those items you regret not having after a spike has glitched your computer.

We picked this particular outlet strip because of some interesting features. First, it has six outlets; each surge protected. Four of the six are switched; the other two are not. For example, the computer, printer, etc., could be plugged into the switched outlets, and your clock and desk lamp could be plugged into the unswitched outlets. You could then flip the computer system off without turning off the clock and desk lamp.

The switch is an illuminated rocker type, and the outlet strip contains a plug replaceable fuse (standard automobile type; 10 amps).

Both the neutral and "hot" lines have varistors to ground. These varistors are meant to catch spikes which exceed 225 VDC. They will divert 50 amps at 440 volts for 20 milliseconds or 2500 amps for 20 microseconds. The two types of failures which surge-protector strips do not guard against are long-term voltage level changes (over voltage and drops; autotransformers are needed for these) and power failures.

The device is constructed with an in-line outlet pattern, heavy gauge metal (painted gray), and has a 6-foot line cord.

Price: \$27.95

**HINT**

(CP/M, TRS-80 diskettes)

You are in BASIC and try to load a file and get a DIRECT STATEMENT IN FILE error. Are you trying to load a data file by mistake?

**COMPUTER CLOCK**

The COMPUTER CLOCK is a cute little (1 1/4" high) quartz crystal controlled LCD clock resembling an Apple II with a large screen monitor on top. It comes with a battery which can be expected to last more than a year. The battery can be reached by pulling out the detachable front screen. Besides being fun to own, it also makes a great gift for the computerist who has everything, or for the forgotten spouse. We get these in large quantities so we can offer you a really good price.

Price: \$3.95 Computer Clock

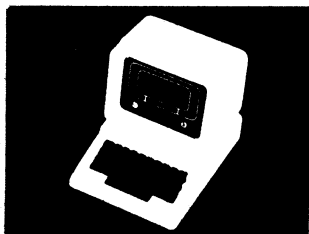

**THE VOTRAX  
PERSONAL SPEECH SYSTEM  
(or DYNACOMP VOTRAX OFFER #2)**

Two years ago DYNACOMP advertised and sold the VOTRAX TYPE 'N' TALK speech synthesizer. We also developed several programs for the unit. Sales initially were good. However, competition quickly built in the form of less expensive speech synthesizers, in particular, the VOICE BOX by the Alien Group. We examined these other units and decided not to carry them (even though they were priced much lower than the TYPE 'N' TALK) because of quality differences. Quite simply, they looked like they were made in someone's garage. Also, they relied heavily on software in the computer to do the brunt of the synthesis work.

Faced with the choice of carrying a high quality product at a high price or a lower priced product which did not please us, we decided to drop speech synthesis hardware altogether — until now.

VOTRAX now has a new synthesizer which does everything the TYPE 'N' TALK did, and much more. After testing the new unit, we are using one ourselves at DYNACOMP. Here are some of the uses we see:

- A programming aid for the blind. The blind person can hear what is typed on the computer's keyboard.
- A programmed telephone response system. Using a Touch Tone decoder, a human can respond to computer generated questions over the phone; an order taking system.
- An order placing system. Push the buttons on the cash register and the order is "spoken" in the kitchen.
- A printer buffer.
- A parallel/serial or serial/parallel converter.

Hooking up a new VOTRAX Personal Speech System is very easy. First, the speaker is contained within the unit (there is also an external jack for another speaker or AUX input). Second, you can connect to the computer either through an RS 232 (DB-25) serial connector, or through a (Centronics) parallel connector. If you can connect a printer to your computer, you can hook up the VOTRAX.

The manual clearly spells out how to hook the system up. We ignored the manual and simply plugged it into an RS 232 port. We weren't surprised when the VOTRAX announced itself, but we were taken back a little when it told us that we had connected it incorrectly! The VOTRAX has a repertoire of error messages to help you set it up and operate it. In this case, we had to switch lines 2 and 3 in the DB-25 connector to get it to respond correctly.

There are many ways to use the VOTRAX. To appreciate the many possible uses, a brief hardware description is useful.

You may choose to send information to the VOTRAX either through the serial or parallel ports. If you choose to use the serial port, you may set switches to determine the baud, parity, hardware (RTS/CTS) or software (X-ON/X-OFF) handshaking, etc. You can override these by sending particular commands to the unit also. The input is buffered (3,500 characters) so that you can quickly (e.g., 9,600 baud) send information to the VOTRAX and have the computer go on about other business while the VOTRAX is speaking. However, the unit echoes back what it is speaking through both the serial and parallel ports. Since you can adjust the speech rate, you have control over the echo speed. Thus you can connect a printer up and use the VOTRAX also as a buffer (spooler). Or you can do serial/parallel or parallel/serial conversion.

VOTRAX combined a synthesizer with a Z80 micro-processor and created an interesting computer! They also included some very interesting features in the internal ROM which supervises this CPU. For example, you can set the time in the VOTRAX and have it say the time

on cue, or automatically (every 15 minutes). You can also program in alarms and cues!

Of course there is a self-test mode (it talks as it tests), volume control, chime, etc. Now we come to the speech (and music) synthesis.

There are two basic speech modes: text and phonetic. You may simply send text to the VOTRAX just as you would to a printer. The VOTRAX is pretty smart and will do a fairly good job of pronouncing it. For example, this catalog description could be sent directly to the VOTRAX with very good results.

In the phonetic mode you can send sound constructions made of phonemes. These can be directly mixed with text-mode speech. For example, you might find the text mode pronunciation of hors d'oeuvre to be not very good. Therefore the phonetic construction might be useful. Included in the package is a 1,400-word dictionary having phonetic equivalents. Text and phonetic pronunciation may be mixed.

You may also control various characteristics of the speech by simple commands sent out with the text.

For example:

Amplitude fade: @ Aar  
a=master audio level (0-F)  
f=fade rate (0-F)

Speech Rate: @ Rr (r=0-F)

Voice mode: @ Vm  
m=0 standard  
m=2 tones off  
m=4 tones on

Inflection: @ i (i=0-7)

Naturally, when the unit is turned on, default values are chosen; you do not have to set any values unless you want to. The same is true for the music and sound-effects mode.

The basic music tone command controls the channel (there are three), note (C1 through B8), duration (in tempo units), hold (in tempo units), amplitude, and glide. You may also control the envelope for each note in the following terms: channel, attack rate, decay rate, sustain level, and release rate. You may also add noise and define the tempo. In other words, you can do a fairly complete job of music synthesis. In addition, you can combine the speech and music modes.

The thing that we found very interesting and appealing is that the unit is not only capable of very complicated speech and music synthesis, but is also very easy to use; you can choose your own level of involvement.

The VOTRAX PERSONAL SPEECH SYSTEM is well built (e.g. the case is cast aluminum) and comes complete with a factory warranty, clear manual, and quick reference card.

Suggested list is \$399.95. DYNACOMP's price is \$329.95. Price does not include cables.

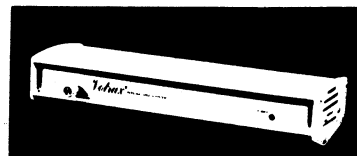

**MAGIC-STAT™  
COMPUTER THERMOSTAT**

**THE STORY**

The story behind DYNACOMP's getting involved with this product is worth telling.

Traditionally, DYNACOMP's president has had low priority when it came to allocating office space. Whenever DYNACOMP needed more space for production, computers, supplies, etc., it expanded into (and through) his office. The movers would be called and he would move to some less vital area. Finally, the next move was to the parking lot!

To solve the space problem, a separate office was built (ground up) for the president. The design, inside and out, was his own. When it came to the thermostat for the heating system, he was going to use a standard Honeywell setback thermostat, the Chronotherm™. However, the one in his home had just broken and, as a result of that unhappy experience, he decided to look more carefully before buying one for the office.

DYNACOMP's president remembered an advertisement for a computerized thermostat from JS&A. He found the same thermostat in the Markline catalog, and purchased it. It arrived. He read the instructions. He installed and programmed it. It was great!

Then he proposed to DYNACOMP's head of marketing that DYNACOMP should carry it. The response was enthusiastic.

As it turns out, the president of Quad Six, Inc., the manufacturer of MAGIC-STAT™, is a DYNACOMP fan, having purchased several DYNACOMP products in the past. Both presidents thought it would be a great idea to put MAGIC-STAT™ into the DYNACOMP catalog. So, here it is.

**THE PRODUCT**

Forget the claims made by JS&A, Markline and the manufacturer's literature. Here are the strengths and weaknesses of MAGIC-STAT™.

**The Strengths:** The MAGIC-STAT™ keeps track of time. During the course of a day you may switch the device to LEARN, set the temperature to what you want it to be *at that time*, and switch back to AUTO. The next day the computer will *figure out* when to turn on the heat so that the temperature will come up to the set point at the desired time (more about this later). You may have *six* different set points each day. Each day in the week may have the same set points (default) or *different* if you wish. This flexibility is great for the weekends. You may also manually override the set point control by simply switching to MANUAL and setting the new temperature. Switching back to AUTO restores the program control at the *next* set point in time.

**The Weaknesses:** You must be around to switch the thermostat to LEARN mode and set the temperature. For example, if you want it to be warm when you get home at 5:30 PM, you must come home to a cold house one day and set the control. The next day it *will be* warm at 5:30 p.m. With this thermostat you program as you go through the day. This is the *only* weakness we see in the operation of MAGIC-STAT™.

**MAGIC STAT 3000**

MAGIC STAT 3000 is a more-expensive version of MAGIC STAT. It is basically the same device, but with the disadvantage, discussed above, remedied. MAGIC STAT 3000 can be programmed very much like a digital watch. It has an LCD (liquid-crystal display) which shows the temperature and time information. Otherwise, its specifications and performance are identical to MAGIC STAT.

**EXTRA ENERGY SAVINGS AND COMFORT**

Here is where the power of the computer really comes to play. As the *outside* temperature changes, the heat must come on earlier or later to make the *inside* transition from cool to warm. What this means for conventional thermostats is that you have to set the thermostat to turn on extra early in the morning to handle those really cold winter nights. But then it comes on too early on the warmer mornings and you are roasted out of bed! MAGIC-STAT™ is *clever*. While operating in the "cool" mode, it tracks the response of your heating system and figures out when the heat should be turned on in order to reach the desired temperature. It is continually learning and adapting! It does not have to be adjusted for the "advance". There are no adjustments. It is automatic. (Note: when going from warm to cool, the temperature is *maintained* until the cool set point is reached, *then* it drops to the new level.)

**The computer allows:**

1. Easier installation - no adjustments.
2. *Much* more comfortable control - the temperature reaches its set point at the right time.
3. Since the heat does not come on too early, there is an energy savings over conventional set-back thermostats - about 5% (you can easily pay for the unit with these savings.)

**THE WARRANTY**

MAGIC-STAT™ is a product which is not only great, but also reliable. It comes with a *three year* "limited warranty" relating to malfunctions.

In short, DYNACOMP found MAGIC-STAT™ to be a great product through personal experience. We are sure you will like it also.

Price \$64.95  
plus \$3.50 shipping & handling

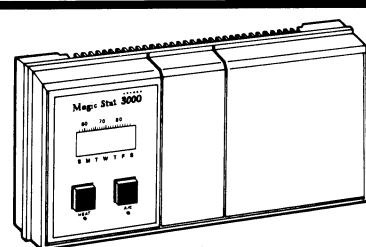
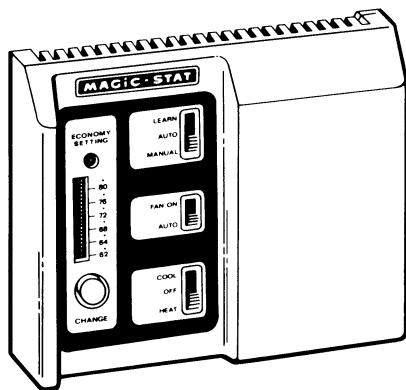

Price: \$89.95  
plus \$3.50 shipping & handling

Not for use with heat pumps or two-stage air conditioning units.

**DISKETTES AND DISKS**

Shipped with Free Storage Boxes (10/Box)

Size	Density	Sides	Price/10
5 1/4"	single	single sided	\$14.95
5 1/4"	double	single sided	\$16.95
5 1/4"	double	double sided	\$18.95

DYNACOMP's diskettes/disks are made of high quality materials and have passed factory quality-control procedures to ensure 100% integrity. All of DYNACOMP's diskettes come with a money-back guarantee on quality and workmanship. Typical brands supplied include NASHUA, DYSAN, and VERBATIM. They are shipped in plastic boxes (see below). Ideal for your Atari, Apple, Osborne, TRS-80, Super Brain, or IBM PC. They are also good as gifts! Guaranteed for one year against defects in manufacturing and workmanship. If you wish to purchase diskettes in bulk for your club or store, call DYNACOMP for our current volume-sale price.

**DISKETTE AND DISK PLASTIC STORAGE BOXES**

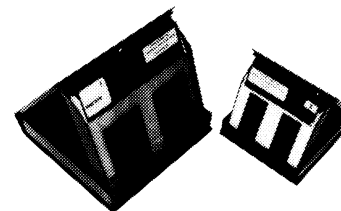

5 1/4" storage box \$2.49  
8" storage box \$3.49

Quantity Discounts:  
10% off for 10 to 19  
15% off for 20 or more

**DISKETTE AND DISK VINYL POCKETS**

Now you can store your diskettes and disks neatly in a 3-ring binder using DYNACOMP vinyl pockets. Two grades of vinyl are commonly sold: reprocessed and virgin vinyl. DYNACOMP sells only those pockets made of the highest quality virgin vinyl. This grade will not contaminate your disk or diskette with excess plasticizer or press lubricant.

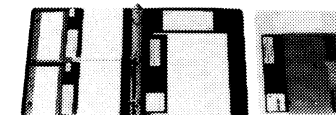

5 1/4" dual pocket holder  
\$.75 ea.  
8" single pocket holder  
\$.75 ea.

Quantity Discounts:  
10% off for 10 to 19  
15% off for 20 to 99  
20% off for 100 or more





BULK RATE  
U.S. POSTAGE  
PAID  
Webster, NY  
Permit No. 14

## DYNACOMP's WARRANTY

### MAGNETICALLY DEFECTIVE MERCHANDISE

If, within 30 days of your purchase, you find the DYNACOMP cassette/diskette/disk to be mechanically or magnetically defective, you may return the original cassette/diskette/disk to your dealer (if you purchased there) or directly to DYNACOMP for replacement. If the fault is due to an original defect in materials or workmanship, DYNACOMP will replace the cassette/diskette/disk free of charge, postpaid.

If, within one year of purchase, you have in any way magnetically damaged the cassette/diskette/disk, DYNACOMP will replace it for a nominal recopying charge of \$5.00 plus \$3.50 for shipping and handling. If you have physically damaged it, there will be an additional nominal charge for replacing the media. See the instructions below regarding what and how to ship to DYNACOMP.

### UNSUITABLE MERCHANDISE

The vast majority of software companies do not warrant the suitability of their software. We are different. DYNACOMP has gone to great lengths (literally!) to describe its products in the DYNACOMP catalog accurately and in sufficient detail to ensure that the customer knows what he or she is purchasing. However, if you purchase a DYNACOMP product and have a problem or are dissatisfied with it, here is what you should do:

- Contact DYNACOMP. You may do this by writing to DYNACOMP directly or by calling one of the technical service lines: (716) 671-6160 or (716) 671-6167. Problems get first priority in the technical support group and they will do whatever they can to help you. Usually the problem turns out to be a bad cassette/diskette/disk, or misunderstanding with respect to the documentation, and is easily remedied.
- If a refund is in order, you will be sent a Copyright Infringement Agreement which is to be signed and included with the returned merchandise (see the shipping instructions below). This agreement simply ensures that you have not retained any copies of the software, and have not permitted others to obtain copies from yours.

When DYNACOMP receives the returned merchandise accompanied by the signed agreement, you will be issued a refund for the purchase price of the material minus a 25% restocking fee.

### VARIATIONS ON THE REFUND THEME

1. If, instead of a refund, you wish to *exchange* for another product of equal or greater price, you must still sign and return the Copyright Infringement Agreement with the returned merchandise. However, in this case there is no restocking fee, and the charge is only for the difference in purchase prices, plus \$3.50 for shipping and handling.
2. If you received a quantity discount for purchasing three or more programs and your return affects this discount, it will be factored into your refund.
3. If you purchased from a dealer and wish a refund, you must make arrangements with that dealer according to his policy.

### SHIPPING INSTRUCTIONS FOR RETURNS

1. Replacement of a defective cassette/diskette/disk: Return only the defective item, not the documentation. Include your sales receipt and a note stating the problem. Carefully pack it (preferably using the protective packing in which it was originally delivered). *DO NOT FOLD, DO NOT BEND, FRAGILE*, etc., markings do not appear to ensure careful handling. Ask yourself: Would this package survive a 3,000 mile trip in your car trunk in a bag full of groceries?
2. Return of merchandise for a refund: Pack as indicated above and include your sales receipt, a note describing the problem, and a signed copy of the Copyright Infringement Agreement.

Deliver to occupant or:

See our supplies section for great prices  
on excellent quality diskettes!